

FEATURES

- 14-bit resolution
- 500kHz sampling rate
- Functionally complete; No missing codes
- Small 24-pin DDIP or SMT package
- Operates from $\pm 15V$ or $\pm 12V$ supplies
- Low power, 1.75 Watts maximum
- Samples up to Nyquist frequencies
- Outstanding dynamic performance
- Bipolar $\pm 5V$ input range



GENERAL DESCRIPTION

The ADS-926 is a high-performance, 14-bit, 500kHz sampling A/D converter. This device accurately samples full-scale input signals up to Nyquist frequencies with no missing codes and exhibits outstanding dynamic performance that surpasses most 16-bit, 500kHz sampling A/D's. THD and SNR, for example, are typically $-90dB$ and $80dB$ when converting full-scale input signals up to 100kHz.

Housed in a small 24-pin DDIP or SMT (gull-wing) package, the functionally complete ADS-926 contains a fast-settling sample-hold amplifier, a subranging (two-pass) A/D converter, a precise voltage reference, timing/control logic, and error-correction circuitry. Digital input and output levels are TTL.

Requiring $\pm 15V$ (or $\pm 12V$) and $+5V$ supplies, the ADS-926 dissipates only 1.75W (1.6W for $\pm 12V$), maximum. The unit is offered with a bipolar input ($-5V$ to $+5V$). Models are available for use in either commercial (0 to $+70^{\circ}C$) or military (-55 to $+125^{\circ}C$) operating temperature ranges.

Applications include radar, sonar, spectrum analysis, and graphic/medical imaging. Contact DATEL for information on devices screened to MIL-STD-883.

INPUT/OUTPUT CONNECTIONS

PIN	FUNCTION	PIN	FUNCTION
1	BIT 14 (LSB)	24	$-12V/-15V$ SUPPLY
2	BIT 13	23	ANALOG GROUND
3	BIT 12	22	$+12V/+15V$ SUPPLY
4	BIT 11	21	$+10V$ REFERENCE OUT
5	BIT 10	20	ANALOG INPUT
6	BIT 9	19	ANALOG GROUND
7	BIT 8	18	BIT 1 (MSB)
8	BIT 7	17	BIT 2
9	BIT 6	16	START CONVERT
10	BIT 5	15	\overline{EOC}
11	BIT 4	14	DIGITAL GROUND
12	BIT 3	13	$+5V$ SUPPLY

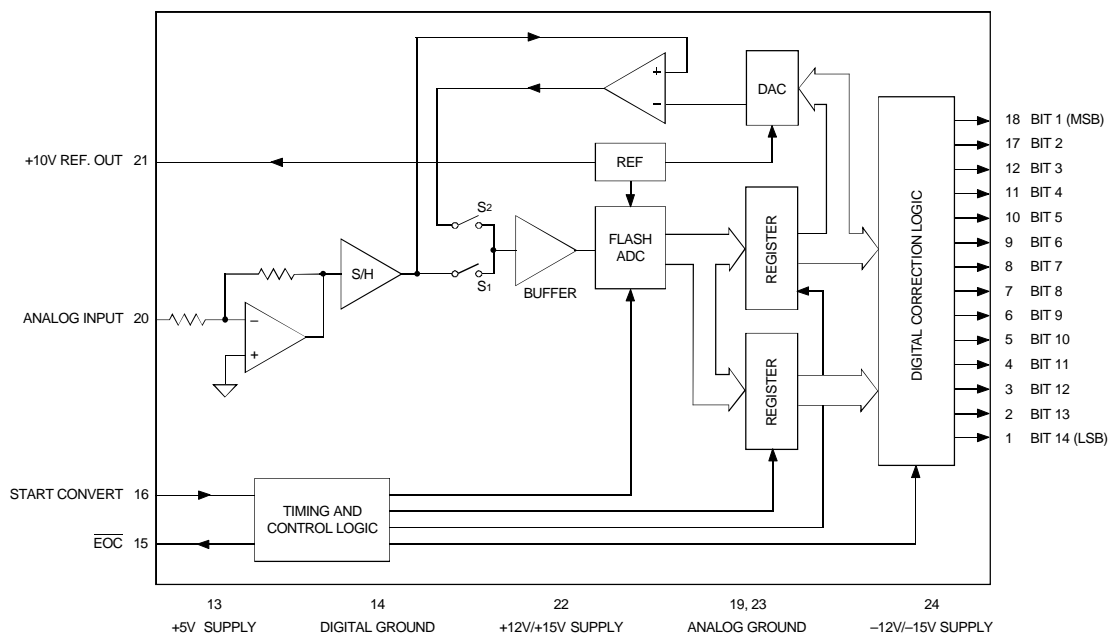

Figure 1. ADS-926 Functional Block Diagram

ABSOLUTE MAXIMUM RATINGS

PARAMETERS	LIMITS	UNITS
+12V/+15V Supply (Pin 22)	0 to +16	Volts
-12V/-15V Supply (Pin 24)	0 to -16	Volts
+5V Supply (Pin 13)	0 to +6	Volts
Digital Input (Pin 16)	-0.3 to +VDD +0.3	Volts
Analog Input (Pin 20)	±15	Volts
Lead Temperature (10 seconds)	+300	°C

PHYSICAL/ENVIRONMENTAL

PARAMETERS	MIN.	TYP.	MAX.	UNITS
Operating Temp. Range, Case ADS-926MC, GC ADS-926MM, GM, 883	0	—	+70	°C
	-55	—	+125	°C
Thermal Impedance θjc θca		6 24		°C/Watt °C/Watt
			+150	°C
Storage Temperature	-65	—	+150	°C
Package Type	24-pin, metal-sealed, ceramic DDIP or SMT			
Weight	0.42 ounces (12 grams)			

FUNCTIONAL SPECIFICATIONS

(TA = +25°C, ±VCC = ±15V (or ±12V), +VDD = +5V, 500kHz sampling rate, and a minimum 1 minute warmup ① unless otherwise specified.)

ANALOG INPUT	+25°C			0 to +70°C			-55 to +125°C			UNITS
	MIN.	TYP.	MAX.	MIN.	TYP.	MAX.	MIN.	TYP.	MAX.	
Input Voltage Range ②	—	±5	—	—	±5	—	—	±5	—	Volts
Input Resistance	—	1	—	—	1	—	—	1	—	kΩ
Input Capacitance	—	7	15	—	7	15	—	7	15	pF
DIGITAL INPUT										
Logic Levels										
Logic "1"	+2.0	—	—	+2.0	—	—	+2.0	—	—	Volts
Logic "0"	—	—	+0.8	—	—	+0.8	—	—	+0.8	Volts
Logic Loading "1"	—	—	+20	—	—	+20	—	—	+20	µA
Logic Loading "0"	—	—	-20	—	—	-20	—	—	-20	µA
Start Convert Positive Pulse Width ③	175	200	225	175	200	225	175	200	225	ns
STATIC PERFORMANCE										
Resolution	—	14	—	—	14	—	—	14	—	Bits
Integral Nonlinearity (fin = 10kHz)	—	±0.5	—	—	±0.75	—	—	±1.5	—	LSB
Differential Nonlinearity (fin = 10kHz)	—	±0.5	±0.95	—	±0.5	±0.95	—	±0.75	±0.99	LSB
Full Scale Absolute Accuracy	—	±0.08	±0.15	—	±0.15	±0.25	—	±0.3	±0.5	%FSR
Bipolar Zero Error (Tech Note 2)	—	±0.05	±0.1	—	±0.1	±0.25	—	±0.15	±0.3	%FSR
Bipolar Offset Error (Tech Note 2)	—	±0.05	±0.1	—	±0.1	±0.25	—	±0.25	±0.4	%FSR
Gain Error (Tech Note 2)	—	±0.1	±0.15	—	±0.15	±0.25	—	±0.25	±0.4	%
No Missing Codes (fin = 10kHz)	14	—	—	14	—	—	14	—	—	Bits
DYNAMIC PERFORMANCE										
Peak Harmonics (-0.5dB)										
dc to 100kHz	—	-92	-88	—	-90	-85	—	-88	-81	dB
100kHz to 250kHz	—	-90	-85	—	-90	-85	—	-86	-80	dB
Total Harmonic Distortion (-0.5dB)										
dc to 100kHz	—	-90	-86	—	-89	-82	—	-87	-78	dB
100kHz to 250kHz	—	-87	-82	—	-87	-82	—	-81	-76	dB
Signal-to-Noise Ratio										
(w/o distortion, -0.5dB)										
dc to 100kHz	78	80	—	78	80	—	74	78	—	dB
100kHz to 250kHz	78	80	—	78	80	—	74	77	—	dB
Signal-to-Noise Ratio ④										
(& distortion, -0.5dB)										
dc to 100kHz	77	79	—	77	79	—	74	78	—	dB
100kHz to 250kHz	77	79	—	77	79	—	73	77	—	dB
Two-Tone Intermodulation										
Distortion (fin = 100kHz, 240kHz, fs = 500kHz, -0.5dB)	—	-87	—	—	-86	—	—	-85	—	dB
Noise	—	300	—	—	300	—	—	350	—	µVrms
Input Bandwidth (-3dB)										
Small Signal (-20dB input)	—	7	—	—	7	—	—	7	—	MHz
Large Signal (-0.5dB input)	—	3	—	—	3	—	—	3	—	MHz
Feedthrough Rejection (fin = 250kHz)	—	84	—	—	84	—	—	84	—	dB
Slew Rate	—	±40	—	—	±40	—	—	±40	—	V/µs
Aperture Delay Time	—	±20	—	—	±20	—	—	±20	—	ns
Aperture Uncertainty	—	5	—	—	5	—	—	5	—	ps rms
S/H Acquisition Time										
(to ±0.003%FSR, 10V step)	1335	1390	1445	1335	1390	1445	1335	1390	1445	ns
Overvoltage Recovery Time ⑤	—	1400	2000	—	1400	2000	—	1400	2000	ns
A/D Conversion Rate	500	—	—	500	—	—	500	—	—	kHz

ANALOG OUTPUT	+25°C			0 to +70°C			-55 to +125°C			UNITS
	MIN.	TYP.	MAX.	MIN.	TYP.	MAX.	MIN.	TYP.	MAX.	
Internal Reference Voltage	+9.95	+10.0	+10.05	+9.95	+10.0	+10.05	+9.95	+10.0	+10.05	Volts
Drift	—	±5	—	—	±5	—	—	±5	—	ppm/°C
External Current	—	—	1.5	—	—	1.5	—	—	1.5	mA
DIGITAL OUTPUTS										
Logic Levels										
Logic "1"	+2.4	—	—	+2.4	—	—	+2.4	—	—	Volts
Logic "0"	—	—	+0.4	—	—	+0.4	—	—	+0.4	Volts
Logic Loading "1"	—	—	-4	—	—	-4	—	—	-4	mA
Logic Loading "0"	—	—	+4	—	—	+4	—	—	+4	mA
Delay, Falling Edge of EOC to Output Data Valid	—	—	35	—	—	35	—	—	35	ns
Output Coding	Offset Binary									
POWER REQUIREMENTS, ±15V										
Power Supply Ranges										
+15V Supply	+14.5	+15.0	+15.5	+14.5	+15.0	+15.5	+14.5	+15.0	+15.5	Volts
-15V Supply	-14.5	-15.0	-15.5	-14.5	-15.0	-15.5	-14.5	-15.0	-15.5	Volts
+5V Supply	+4.75	+5.0	+5.25	+4.75	+5.0	+5.25	+4.75	+5.0	+5.25	Volts
Power Supply Currents										
+15V Supply	—	+41	+60	—	+41	+60	—	+41	+60	mA
-15V Supply	—	-23	-40	—	-23	-40	—	-23	-40	mA
+5V Supply	—	+71	+85	—	+71	+85	—	+71	+85	mA
Power Dissipation	—	1.4	1.75	—	1.4	1.75	—	1.4	1.75	Watts
Power Supply Rejection	—	—	±0.02	—	—	±0.02	—	—	±0.02	%FSR/%V
POWER REQUIREMENTS, ±12V										
Power Supply Ranges										
+12V Supply	+14.5	+15.0	+15.5	+14.5	+15.0	+15.5	+14.5	+15.0	+15.5	Volts
-12V Supply	-14.5	-15.0	-15.5	-14.5	-15.0	-15.5	-14.5	-15.0	-15.5	Volts
+5V Supply	+4.75	+5.0	+5.25	+4.75	+5.0	+5.25	+4.75	+5.0	+5.25	Volts
Power Supply Currents										
+12V Supply	—	+41	+60	—	+41	+60	—	+41	+60	mA
-12V Supply	—	-23	-40	—	-23	-40	—	-23	-40	mA
+5V Supply	—	+71	+85	—	+71	+85	—	+71	+85	mA
Power Dissipation	—	1.3	1.6	—	1.3	1.6	—	1.3	1.6	Watts
Power Supply Rejection	—	—	±0.02	—	—	±0.02	—	—	±0.02	%FSR/%V
Footnotes:										
① All power supplies must be on before applying a start convert pulse. All supplies and the clock (START CONVERT) must be present during warmup periods. The device must be continuously converting during this time.					④ Effective bits is equal to: $\frac{(\text{SNR} + \text{Distortion}) - 1.76 + \left[20 \log \frac{\text{Full Scale Amplitude}}{\text{Actual Input Amplitude}} \right]}{6.02}$					
② See Ordering Information for 0 to +10V input range. Contact DATEL for availability of other input voltage ranges.					⑤ This is the time required before the A/D output data is valid after the analog input is back within the specified range.					
③ A 500kHz clock with a 200ns wide start convert pulse is used for all production testing. For applications requiring less than a 500kHz sampling rate, wider start convert pulses can be used. See Timing Diagram for more details.										

TECHNICAL NOTES

- Obtaining fully specified performance from the ADS-926 requires careful attention to pc-card layout and power supply decoupling. The device's analog and digital ground systems are connected to each other internally. For optimal performance, tie all ground pins (14, 19 and 23) directly to a large **analog** ground plane beneath the unit.

Bypass all power supplies and the REFERENCE OUTPUT (pin 21) to ground with 4.7µF tantalum capacitors in parallel with 0.1µF ceramic capacitors. Locate the bypass capacitors as close to the unit as possible. If the user-installed offset and gain adjusting circuit shown in Figure 2 is used, also locate it as close to the ADS-926 as possible.
- The ADS-926 achieves its specified accuracies without the

- need for external calibration. If required, the device's small initial offset and gain errors can be reduced to zero using the input circuit of Figure 2. When using this circuit, or any similar offset and gain-calibration hardware, make adjustments following warmup. To avoid interaction, always adjust offset before gain.
- When operating the ADS-926 from ±12V supplies, do not drive external circuitry with the REFERENCE OUTPUT. The reference's accuracy and drift specifications may not be met, and loading the circuit may cause accuracy errors within the converter.
 - Applying a start convert pulse while a conversion is in progress (EOC = logic "1") initiates a new and inaccurate conversion cycle. Data for the interrupted and subsequent conversions will be invalid.

CALIBRATION PROCEDURE

(Refer to Figures 2 and 3)

Any offset and/or gain calibration procedures should not be implemented until devices are fully warmed up. To avoid interaction, offset must be adjusted before gain. The ranges of adjustment for the circuit of Figure 2 are guaranteed to compensate for the ADS-926's initial accuracy errors and may not be able to compensate for additional system errors.

All fixed resistors in Figure 2 should be metal-film types, and multturn potentiometers should have TCR's of 100ppm/°C or less to minimize drift with temperature.

A/D converters are calibrated by positioning their digital outputs exactly on the transition point between two adjacent digital output codes. This can be accomplished by connecting LED's to the digital outputs and adjusting until certain LED's "flicker" equally between on and off. Other approaches employ digital comparators or microcontrollers to detect when the outputs change from one code to the next.

For the ADS-926, offset adjusting is normally accomplished at the point where the MSB is a 1 and all other output bits are 0's and the LSB just changes from a 0 to a 1. This digital output transition ideally occurs when the applied analog input is $\pm\frac{1}{2}$ LSB ($\pm 305\mu\text{V}$).

Gain adjusting is accomplished when all bits are 1's and the LSB just changes from a 1 to a 0. This transition ideally occurs when the analog input is at +full scale minus $1\frac{1}{2}$ LSB's ($+4.999085\text{V}$).

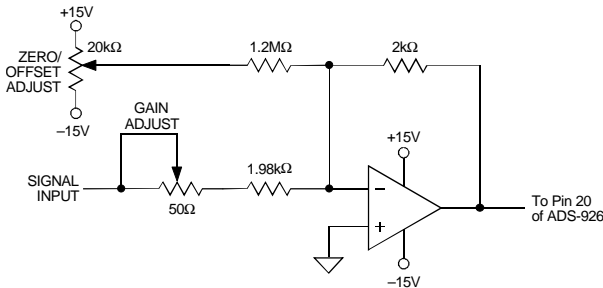

Figure 2. ADS-926 Calibration Circuit

Zero/Offset Adjust Procedure

1. Apply a train of pulses to the START CONVERT input (pin 16) so the converter is continuously converting. If using LED's on the outputs, a 200kHz conversion rate will reduce flicker.
2. Apply $+305\mu\text{V}$ to the ANALOG INPUT (pin 20).
3. Adjust the offset potentiometer until the output bits are a 1 and all 0's and the LSB flickers between 0 and 1.

Gain Adjust Procedure

1. Apply $+4.999085\text{V}$ to the ANALOG INPUT (pin 20).
2. Adjust the gain potentiometer until the output bits are all 1's and the LSB flickers between 1 and 0.

Table 1. Zero and Gain Adjust

INPUT VOLTAGE RANGE	ZERO ADJUST $\pm\frac{1}{2}$ LSB	GAIN ADJUST $\pm\text{FS} - 1\frac{1}{2}$ LSB
$\pm 5\text{V}$	$+305\mu\text{V}$	$+4.999085\text{V}$

Table 2. Output Coding

OUTPUT CODING MSB LSB	INPUT RANGE $\pm 5\text{V}$	BIPOLAR SCALE
11 1111 1111 1111	$+4.99939$	$+\text{FS} - 1 \text{ LSB}$
11 1000 0000 0000	$+3.75000$	$+3/4 \text{ FS}$
11 0000 0000 0000	$+2.50000$	$+1/2 \text{ FS}$
10 0000 0000 0000	0.00000	0
01 0000 0000 0000	-2.50000	$-1/2 \text{ FS}$
00 1000 0000 0000	-3.75000	$-3/4 \text{ FS}$
00 0000 0000 0001	-4.99939	$-\text{FS} + 1 \text{ LSB}$
00 0000 0000 0000	-5.00000	$-\text{FS}$

Coding is offset binary; 1LSB = $610\mu\text{V}$.

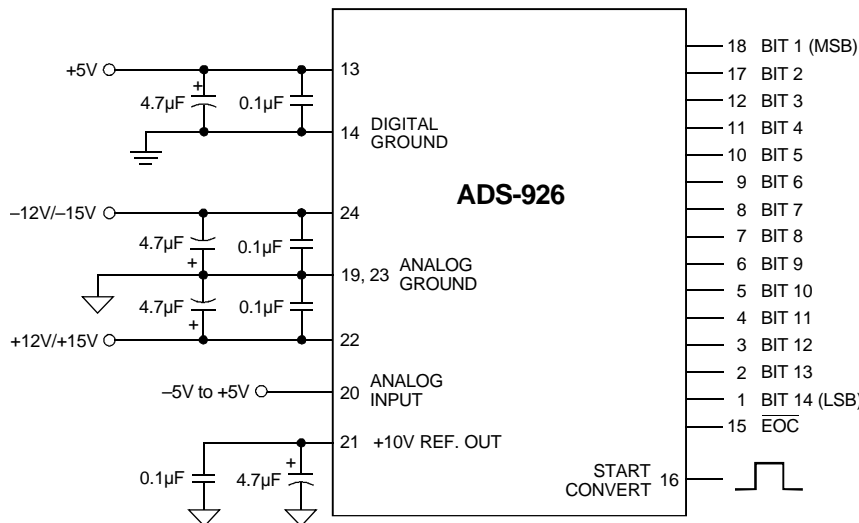

Figure 3. Typical ADS-926 Connection Diagram

THERMAL REQUIREMENTS

All DATEL sampling A/D converters are fully characterized and specified over operating temperature (case) ranges of 0 to +70°C and -55 to +125°C. All room-temperature ($T_A = +25^\circ\text{C}$) production testing is performed without the use of heat sinks or forced-air cooling. Thermal impedance figures for each device are listed in their respective specification tables.

These devices do not normally require heat sinks, however, standard precautionary design and layout procedures should be used to ensure devices do not overheat. The ground and power planes beneath the package, as well as all pcb signal runs to and from the device, should be as heavy as possible to help conduct heat away from the package.

Electrically-insulating, thermally-conductive "pads" may be installed underneath the package. Devices should be soldered to boards rather than "socketed", and of course, minimal air flow over the surface can greatly help reduce the package temperature.

In more severe ambient conditions, the package/junction temperature of a given device can be reduced dramatically (typically 35%) by using one of DATEL's HS Series heat sinks. See Ordering Information for the assigned part number. See page 1-183 of the DATEL Data Acquisition Components Catalog for more information on the HS Series. Request DATEL Application Note AN-8, "Heat Sinks for DIP Data Converters", or contact DATEL directly, for additional information.

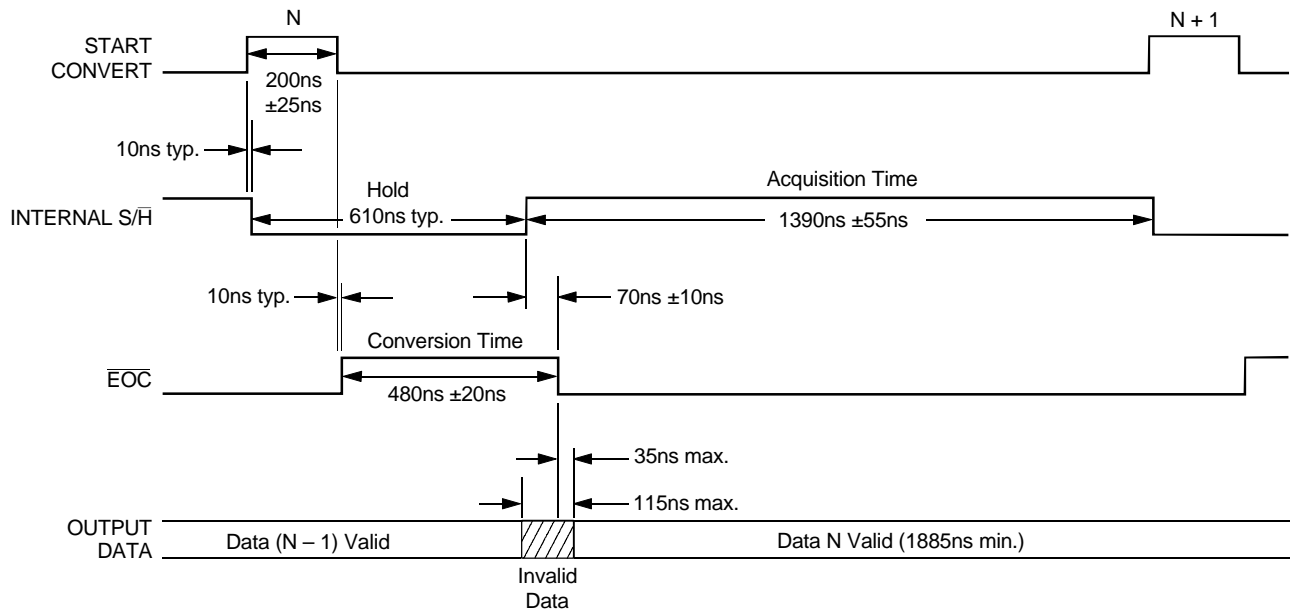

Notes: 1. $f_s = 500\text{kHz}$.

- The ADS-926 is a pulse-triggered device. Its internal operations are triggered by both the rising and falling edges of the start convert pulse. When sampling at 500kHz, the start pulse must be between 175 and 225nsec wide. For lower sampling rates, wider start pulses may be used, however, a 50nsec minimum pulse width low must be maintained.

Figure 4. ADS-926 Timing Diagram

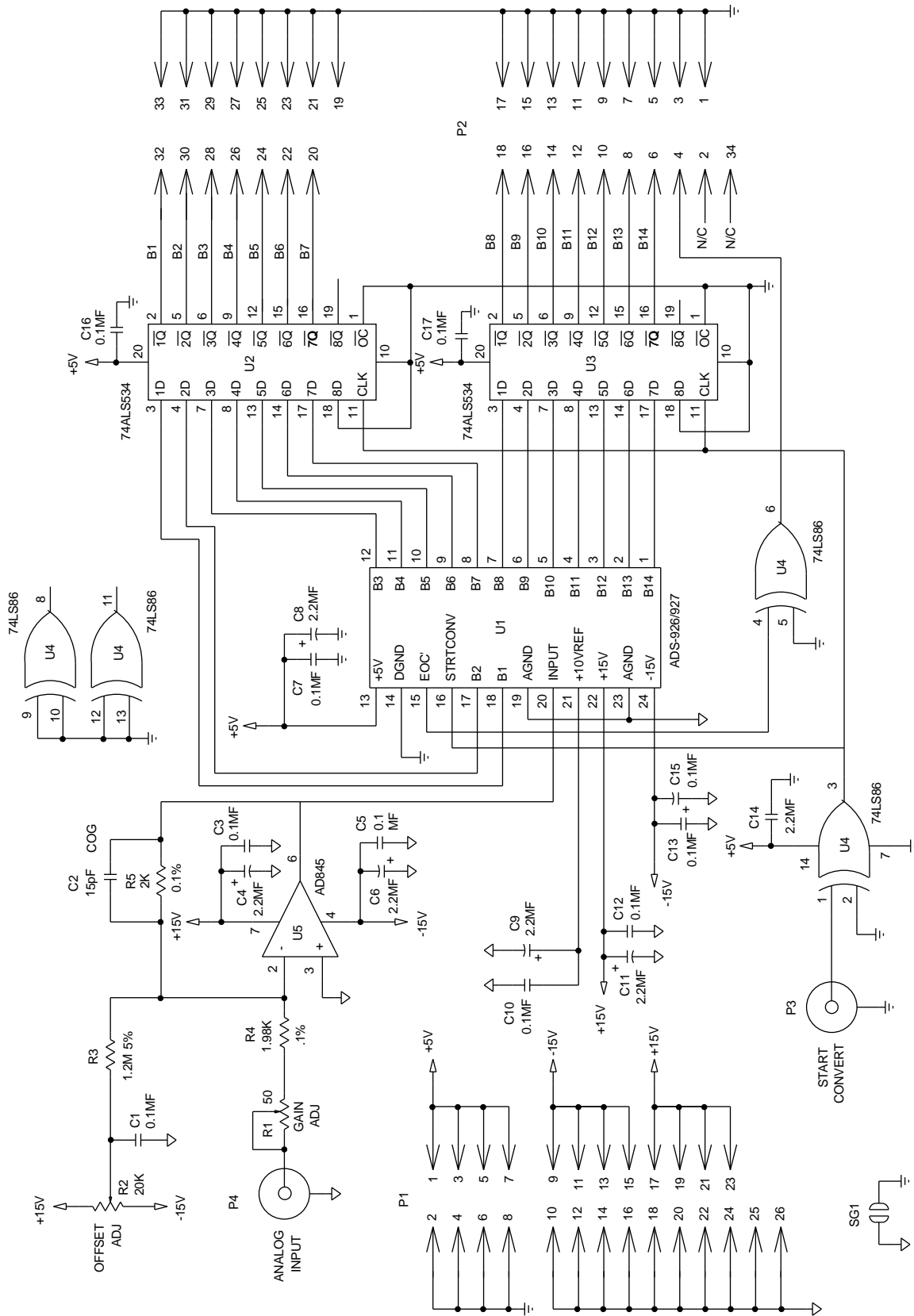
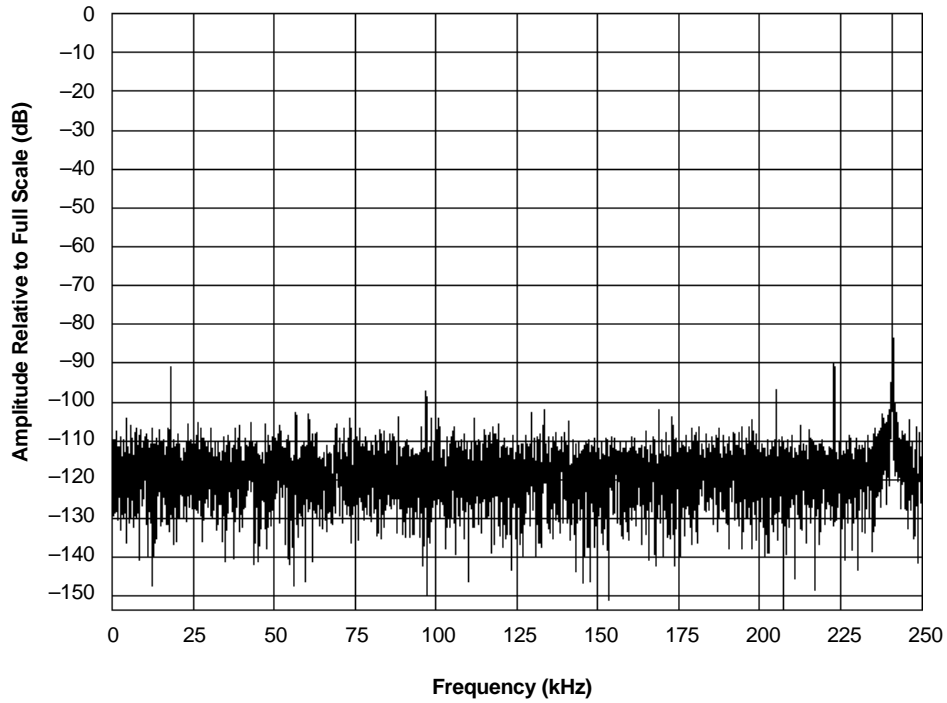

Figure 5. ADS-926 Evaluation Board Schematic



(fs = 500kHz, fin = 240kHz, Vin = -0.5dB, 16,384-point FFT)

Figure 6. ADS-926 FFT Analysis

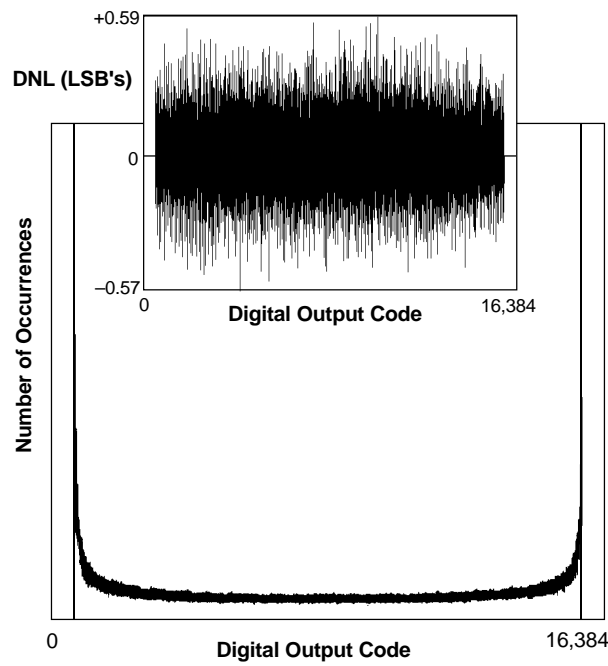
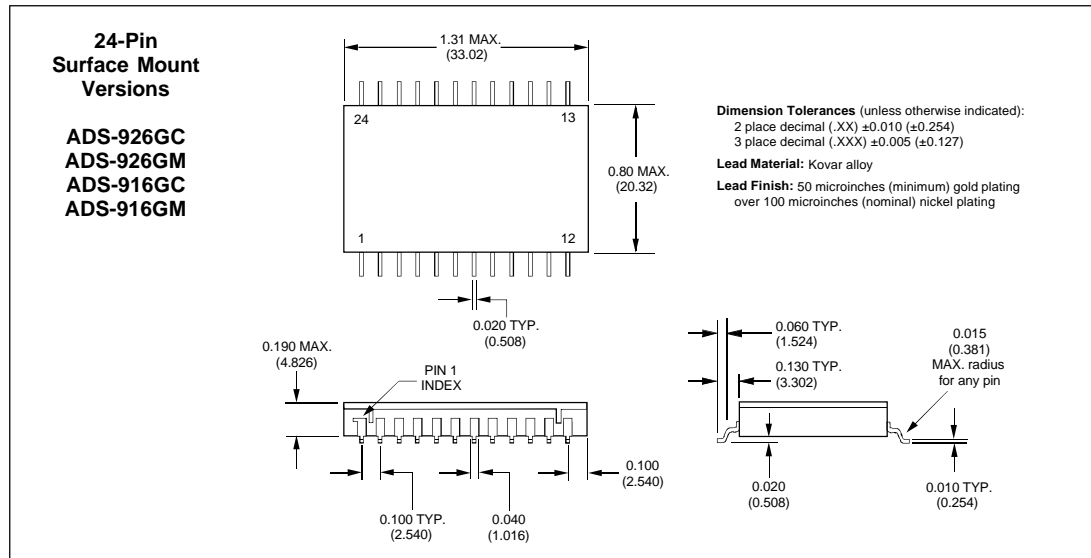
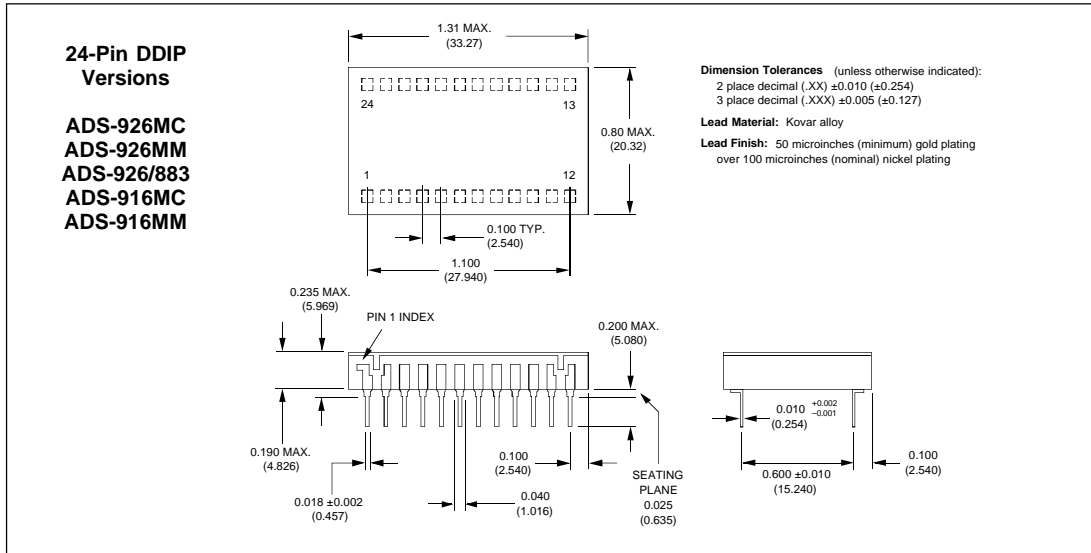

Figure 7. ADS-926 Histogram and Differential Nonlinearity

MECHANICAL DIMENSIONS INCHES (mm)



ORDERING INFORMATION

MODEL NUMBER	OPERATING TEMP. RANGE	ANALOG INPUT	ACCESSORIES
ADS-926MC	0 to +70°C	Bipolar ($\pm 5V$)	ADS-B926/927 Evaluation Board (without ADS-926)
ADS-926MM	-55 to +125°C	Bipolar ($\pm 5V$)	HS-24 Heat Sinks for all ADS-916/926 DDIP models.
ADS-926/883	-55 to +125°C	Bipolar ($\pm 5V$)	
ADS-926GC	0 to +70°C	Bipolar ($\pm 5V$)	Receptacles for PC board mounting can be ordered through AMP Inc. Part #3-331272-8 (Component Lead Socket), 24 required.
ADS-926GM	-55 to +125°C	Bipolar ($\pm 5V$)	For MIL-STD-883 product specifications, contact DATEL.
ADS-916MC	0 to +70°C	Unipolar (0 to +10V)*	* For information, see ADS-916 data sheet.
ADS-916MM	-55 to +125°C	Unipolar (0 to +10V)*	
ADS-916GC	0 to +70°C	Unipolar (0 to +10V)*	
ADS-916GM	-55 to +125°C	Unipolar (0 to +10V)*	