

# MOS FIELD EFFECT TRANSISTOR 2SJ243

### P-CHANNEL MOS FET FOR SWITCHING

The 2SJ243 is a P-channel vertical type MOS FET that is driven at 2.5 V.

Because this MOS FET can be driven on a low voltage and because it is not necessary to consider the drive current, the 2SJ243 is ideal for driving the actuator of power-saving systems, such as VCR cameras and headphone stereo systems.

Moreover, the 2SJ243 is housed in a super small mini-mold package so that it can help increase the mounting density on the printed circuit board and lower the mounting cost, contributing to miniaturization of the application systems.

#### FEATURES

- Small mounting area: about 60 % of the conventional mini-mold package (SC-70)
- Can be directly driven by 3-V IC
- Can be automatically mounted

The internal diode in the right figure is a parasitic diode.

The protection diode is to protect the product from damage due to static electricity. If there is a danger that an extremely high voltage will be applied across the gate and source in the actual circuit, a gate protection circuit such as an external constant-voltage diode is necessary.

#### PACKAGE DIMENSIONS (in mm)

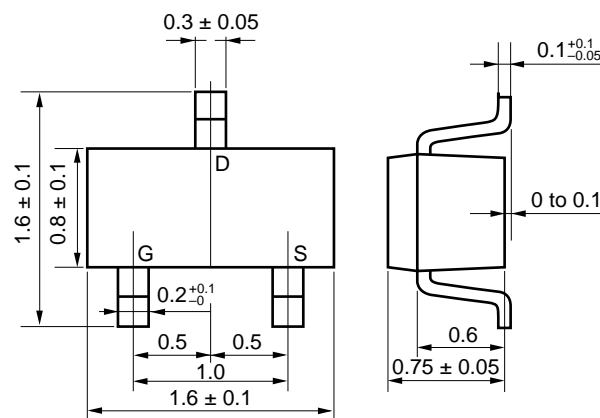

#### EQUIVALENT CIRCUIT

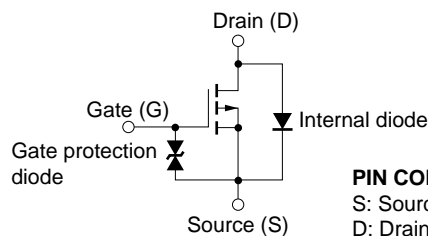

#### PIN CONNECTIONS

S: Source  
D: Drain  
G: Gate

Marking: A1

#### ABSOLUTE MAXIMUM RATINGS (T<sub>A</sub> = 25 °C)

PARAMETER	SYMBOL	TEST CONDITIONS	RATING	UNIT
Drain to Source Voltage	V <sub>DSS</sub>	V <sub>GS</sub> = 0	-30	V
Gate to Source Voltage	V <sub>GSS</sub>	V <sub>DS</sub> = 0	±7	V
Drain Current (DC)	I <sub>D(DC)</sub>		±100	mA
Drain Current (Pulse)	I <sub>D(pulse)</sub>	PW ≤ 10 ms Duty cycle ≤ 50 %	±200	mA
Total Power Dissipation	P <sub>T</sub>	3.0 cm <sup>2</sup> × 0.64 mm, ceramic substrate used	200	mW
Channel Temperature	T <sub>ch</sub>		150	°C
Operating Temperature	T <sub>opt</sub>		-55 to +80	°C
Storage Temperature	T <sub>stg</sub>		-55 to +150	°C

**ELECTRICAL CHARACTERISTICS (T<sub>A</sub> = 25 °C)**

PARAMETER	SYMBOL	TEST CONDITIONS	MIN.	TYP.	MAX.	UNIT
Drain Cut-Off Current	I <sub>DSS</sub>	V <sub>DS</sub> = -30 V, V <sub>GS</sub> = 0			-1.0	μA
Gate Leakage Current	I <sub>GSS</sub>	V <sub>GS</sub> = ±5 V, V <sub>DS</sub> = 0		±0.1	±3.0	μA
Gate Cut-Off Voltage	V <sub>GS(off)</sub>	V <sub>DS</sub> = -3 V, I <sub>b</sub> = -10 μA	-1.6	-1.9	-2.3	V
Forward Transfer Admittance	y <sub>ts</sub>	V <sub>DS</sub> = -3 V, I <sub>b</sub> = 10 mA	20	30		mS
Drain to Source On-State Resistance	R <sub>DS(on)1</sub>	V <sub>GS</sub> = -2.5 V, I <sub>b</sub> = -1 mA		55	100	Ω
Drain to Source On-State Resistance	R <sub>DS(on)2</sub>	V <sub>GS</sub> = -4.0 V, I <sub>b</sub> = -10 mA		20	25	Ω
Input Capacitance	C <sub>iss</sub>	V <sub>DS</sub> = -5.0 V, V <sub>GS</sub> = 0, f = 1 MHz		16		pF
Output Capacitance	C <sub>oss</sub>			13		pF
Reverse Transfer Capacitance	C <sub>rss</sub>			2		pF
Turn-On Delay Time	t <sub>d(on)</sub>	V <sub>DD</sub> = -5V, I <sub>b</sub> = -10 mA V <sub>GS(on)</sub> = -5 V, R <sub>G</sub> = 10 Ω R <sub>L</sub> = 500 Ω		10		ns
Rise Time	t <sub>r</sub>			40		ns
Turn-Off Delay Time	t <sub>d(off)</sub>			130		ns
Fall Time	t <sub>f</sub>			80		ns

**SWITCHING TIME MEASUREMENT CIRCUIT AND CONDITIONS (Resistive Load)**

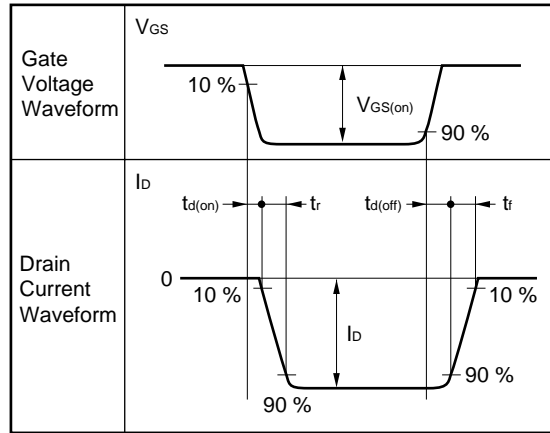
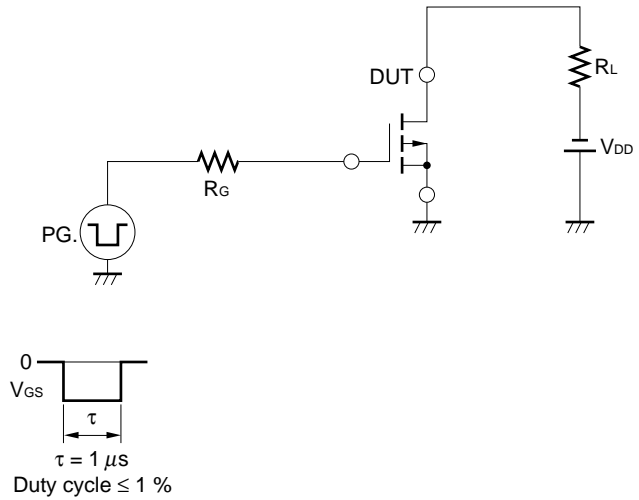

TYPICAL CHARACTERISTICS (T<sub>A</sub> = 25 °C)

DERATING FACTOR OF FORWARD BIAS SAFE OPERATING AREA

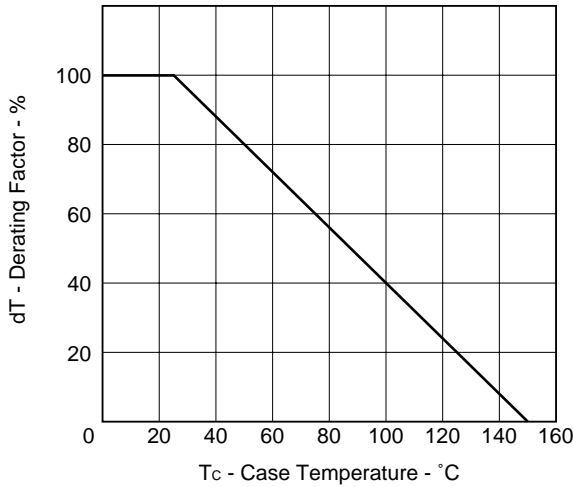

TOTAL POWER DISSIPATION vs. AMBIENT TEMPERATURE

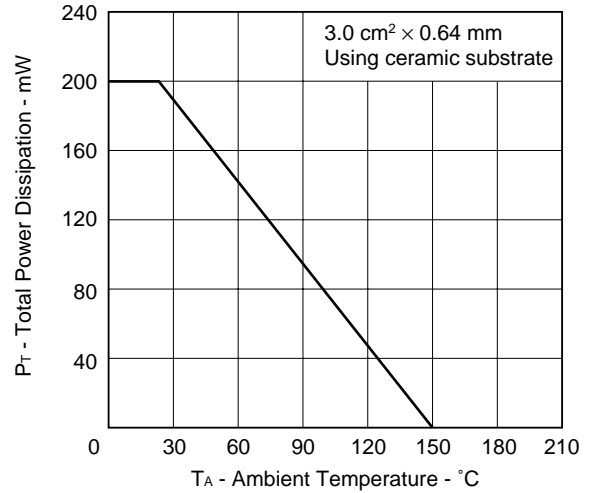

TRANSFER CHARACTERISTICS

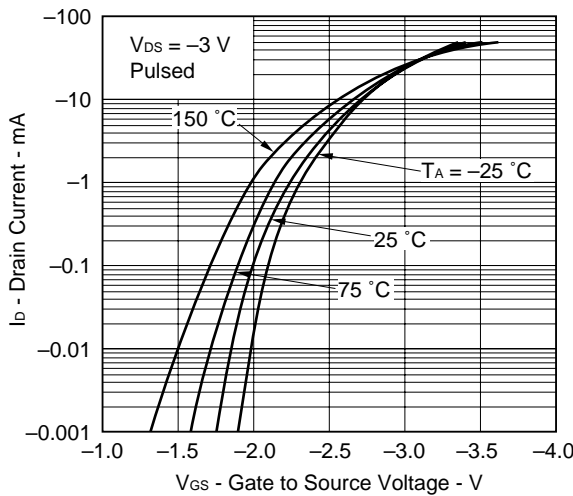

FORWARD TRANSFER ADMITTANCE vs. DRAIN CURRENT

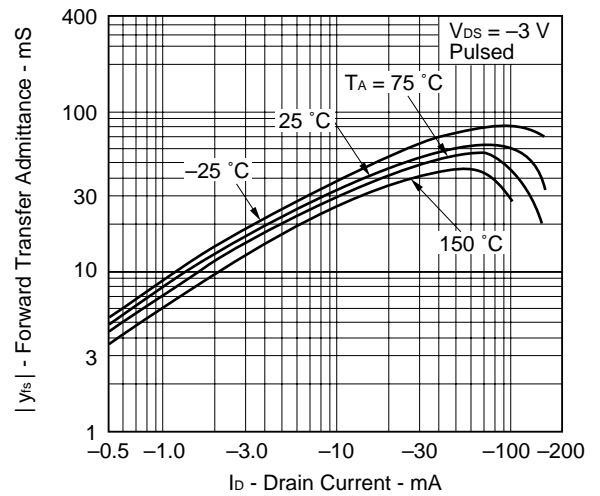

DRAIN TO SOURCE ON-STATE RESISTANCE vs. GATE TO SOURCE VOLTAGE

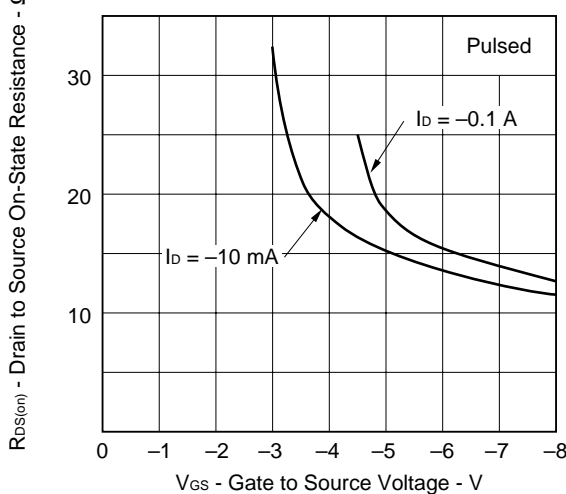

DRAIN TO SOURCE ON-STATE RESISTANCE vs. DRAIN CURRENT

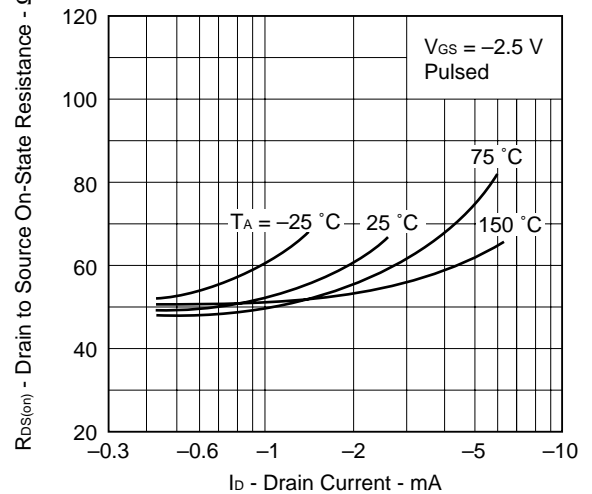

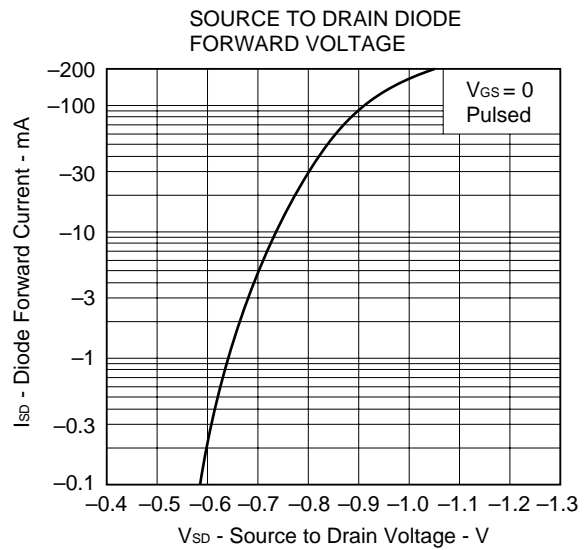
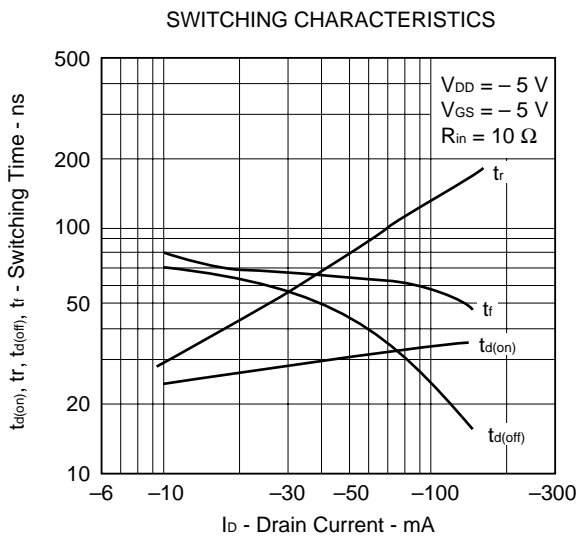
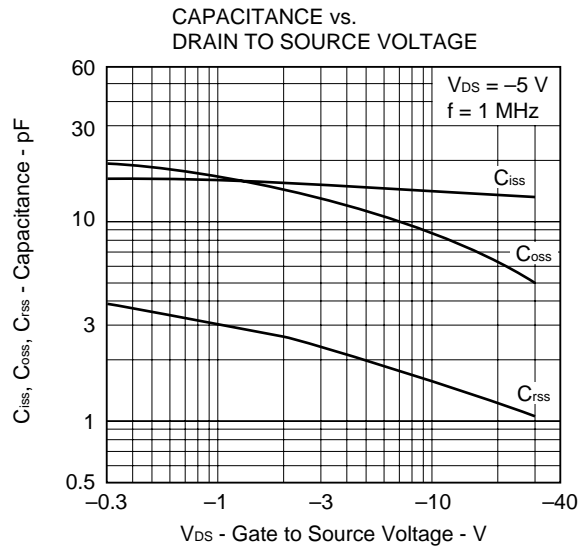
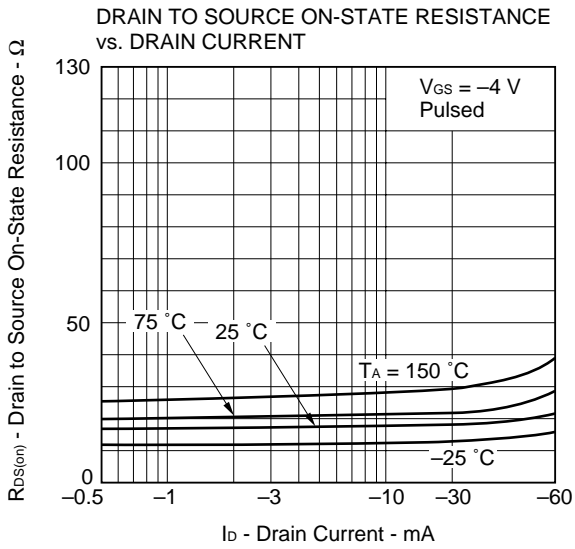

**REFERENCE**

Document Name	Document No.
NEC semiconductor device reliability/quality control system	TEI-1202
Quality grade on NEC semiconductor devices	IEI-1209
Semiconductor device mounting technology manual	C10535E
Guide to quality assurance for semiconductor devices	MEI-1202
Semiconductor selection guide	X10679E

## [MEMO]

No part of this document may be copied or reproduced in any form or by any means without the prior written consent of NEC Corporation. NEC Corporation assumes no responsibility for any errors which may appear in this document.

NEC Corporation does not assume any liability for infringement of patents, copyrights or other intellectual property rights of third parties by or arising from use of a device described herein or any other liability arising from use of such device. No license, either express, implied or otherwise, is granted under any patents, copyrights or other intellectual property rights of NEC Corporation or others.

While NEC Corporation has been making continuous effort to enhance the reliability of its semiconductor devices, the possibility of defects cannot be eliminated entirely. To minimize risks of damage or injury to persons or property arising from a defect in an NEC semiconductor device, customer must incorporate sufficient safety measures in its design, such as redundancy, fire-containment, and anti-failure features.

NEC devices are classified into the following three quality grades:

“Standard”, “Special”, and “Specific”. The Specific quality grade applies only to devices developed based on a customer designated “quality assurance program” for a specific application. The recommended applications of a device depend on its quality grade, as indicated below. Customers must check the quality grade of each device before using it in a particular application.

Standard: Computers, office equipment, communications equipment, test and measurement equipment, audio and visual equipment, home electronic appliances, machine tools, personal electronic equipment and industrial robots

Special: Transportation equipment (automobiles, trains, ships, etc.), traffic control systems, anti-disaster systems, anti-crime systems, safety equipment and medical equipment (not specifically designed for life support)

Specific: Aircrafts, aerospace equipment, submersible repeaters, nuclear reactor control systems, life support systems or medical equipment for life support, etc.

The quality grade of NEC devices in “Standard” unless otherwise specified in NEC's Data Sheets or Data Books. If customers intend to use NEC devices for applications other than those specified for Standard quality grade, they should contact NEC Sales Representative in advance.

Anti-radioactive design is not implemented in this product.