

Cascadable Silicon Bipolar MMIC Amplifier

Technical Data

MSA-9970

Features

- **Open Loop Feedback Amplifier**
- **Performance Flexibility with User Selected External Feedback for:**
 - Broadband Minimum Ripple Amplifiers
 - Low Return Loss Amplifiers
 - Negative Gain Slope Amplifiers
- **Usable Gain to 6.0 GHz**
- **16.0 dB Typical Open Loop Gain at 1.0 GHz**
- **14.5 dBm Typical P_{1dB} at 1.0 GHz**
- **Hermetic Gold-ceramic Microstrip Package**

Description

The MSA-9970 is a high performance silicon bipolar Monolithic Microwave Integrated Circuit (MMIC) housed in a hermetic high reliability package. This MMIC is designed with high open loop gain and is intended to be used with external resistive and reactive feedback elements to create a variety of special purpose gain blocks.

Applications include very broadband, minimum ripple amplifiers with extended low frequency performance possible through the use of a high valued external feedback blocking capacitor; extremely well matched (-20 dB return loss) amplifiers; and negative gain slope amplifiers for flattening MMIC cascades.

70 mil Package

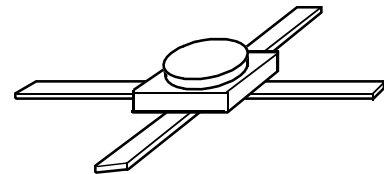

The MSA-series is fabricated using HP's 10 GHz f_T , 25 GHz f_{MAX} , silicon bipolar MMIC process which uses nitride self-alignment, ion implantation, and gold metallization to achieve excellent performance, uniformity and reliability. The use of an external bias resistor for temperature and current stability also allows bias flexibility.

Typical Biasing Configuration

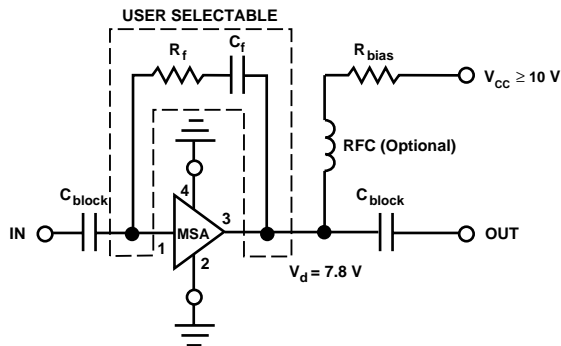

MSA-9970 Absolute Maximum Ratings

Parameter	Absolute Maximum ^[1]
Device Current	80 mA
Power Dissipation ^[2,3]	750 mW
RF Input Power	+13 dBm
Junction Temperature	200°C
Storage Temperature	-65°C to 200°C

Thermal Resistance^[2,4]:

$$\theta_{jc} = 150^{\circ}\text{C}/\text{W}$$

Notes:

1. Permanent damage may occur if any of these limits are exceeded.
2. $T_{\text{CASE}} = 25^{\circ}\text{C}$.
3. Derate at 6.7 mW/°C for $T_{\text{C}} > 88^{\circ}\text{C}$.
4. The small spot size of this technique results in a higher, though more accurate determination of θ_{jc} than do alternate methods. See MEASUREMENTS section "Thermal Resistance" for more information.

Electrical Specifications^[1], $T_{\text{A}} = 25^{\circ}\text{C}$

Symbol	Parameters and Test Conditions: $I_{\text{d}} = 35 \text{ mA}$, $Z_{\text{o}} = 50 \Omega$	Units	Min.	Typ.	Max.
G_{P}	Power Gain ^[2] ($ S_{21} ^2$) f = 0.1 GHz f = 1.0 GHz f = 4.0 GHz	dB	14.5 8.0	17.5 16.0 9.0	17.5 10.0
$P_{1 \text{ dB}}$	Output Power at 1 dB Gain Compression ^[2] f = 1.0 GHz	dBm		14.5	
IP_3	Third Order Intercept Point ^[2] f = 1.0 GHz	dBm		25.0	
V_{d}	Device Voltage	V	7.0	7.8	8.6
dV/dT	Device Voltage Temperature Coefficient	mV/°C		-16.0	

Notes:

1. The recommended operating current range for this device is 25 to 45 mA. Typical performance as a function of current is on the following page.
2. Open loop value. Adding external feedback will alter device performance.

MSA-9970 Typical Scattering Parameters ($Z_0 = 50 \Omega$, $T_A = 25^\circ\text{C}$, $I_d = 35 \text{ mA}$)

Freq. GHz	S ₁₁		S ₂₁			S ₁₂			S ₂₂		k
	Mag	Ang	dB	Mag	Ang	dB	Mag	Ang	Mag	Ang	
0.02	.89	-1	17.5	7.51	179	-37.2	.014	4	.93	-1	1.01
0.05	.90	-3	17.5	7.47	177	-35.6	.017	34	.92	-3	.83
0.1	.90	-6	17.4	7.45	174	-33.2	.022	43	.93	-6	.70
0.2	.89	-12	17.4	7.43	168	-29.6	.033	61	.93	-13	.39
0.4	.87	-24	17.2	7.27	156	-24.4	.061	63	.91	-27	.24
0.6	.85	-36	17.0	7.06	145	-20.8	.091	58	.90	-40	.21
0.8	.82	-47	16.6	6.78	134	-18.8	.115	52	.87	-53	.21
1.0	.79	-59	16.2	6.49	124	-17.0	.141	44	.84	-66	.24
1.5	.72	-86	15.3	5.79	100	-14.6	.186	29	.74	-96	.28
2.0	.65	-113	14.2	5.10	77	-13.4	.215	16	.64	-123	.34
2.5	.59	-133	13.0	4.45	61	-12.9	.227	7	.57	-143	.39
3.0	.54	-155	11.6	3.79	42	-12.5	.236	-3	.51	-163	.46
3.5	.53	-174	10.3	3.28	26	-12.4	.239	-14	.45	178	.53
4.0	.52	168	9.2	2.87	10	-12.5	.238	-22	.39	164	.59
4.5	.53	152	8.0	2.51	-4	-12.6	.234	-30	.34	155	.66
5.0	.55	140	6.9	2.21	-17	-12.8	.228	-37	.31	153	.72
5.5	.55	130	5.8	1.94	-31	-13.2	.220	-44	.30	154	.80
6.0	.55	121	4.6	1.70	-43	-13.6	.209	-48	.32	157	.88
6.5	.56	114	3.5	1.50	-53	-13.8	.203	-54	.37	158	.94
7.0	.56	107	2.6	1.34	-63	-14.0	.201	-59	.42	157	.97

A model for this device is available in the DEVICE MODELS section.

Typical Performance, $T_A = 25^\circ\text{C}$

(unless otherwise noted)

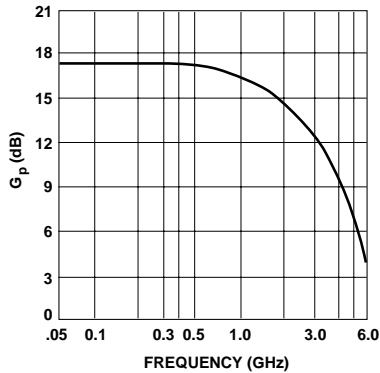

Figure 1. Open Loop Power Gain vs. Frequency, $I_d = 35 \text{ mA}$.

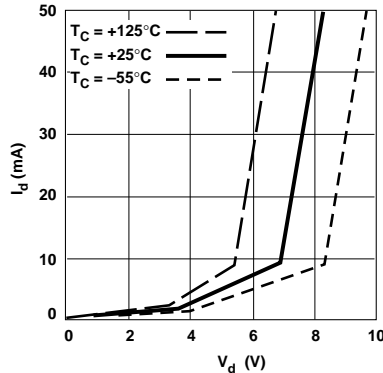

Figure 2. Device Current vs. Voltage.

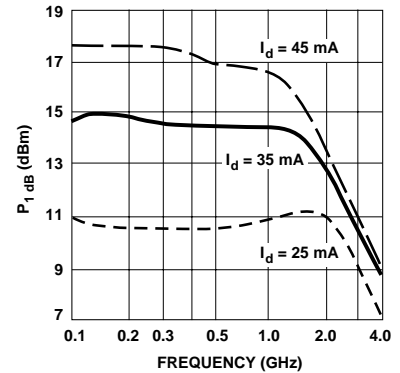

Figure 3. Open Loop Output Power at 1 dB Gain Compression vs. Frequency.

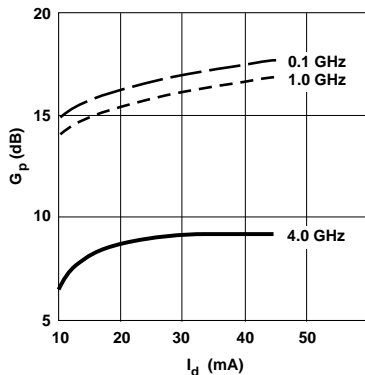

Figure 4. Open Loop Power Gain vs. Current.

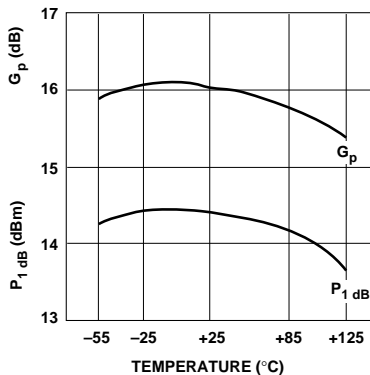

Figure 5. Open Loop Output Power at 1 dB Gain Compression and Open Loop Power Gain vs. Case Temperature, $f=1.0 \text{ GHz}$, $I_d = 35 \text{ mA}$.

70 mil Package Dimensions

