

TOSHIBA BIPOLAR LINEAR INTEGRATED CIRCUIT SILICON MONOLITHIC
TA78M05S, TA78M06S, TA78M08S, TA78M09S, TA78M10S
TA78M12S, TA78M15S, TA78M18S, TA78M20S, TA78M24S

0.5A THREE TERMINAL POSITIVE VOLTAGE REGULATORS
5V, 6V, 8V, 9V, 10V, 12V, 15V, 18V, 20V, 24V

The TA78M x xS series of fixed-voltage monolithic integrated circuit voltage regulators is designed for a wide range of applications. These regulators employ internal current-limiting, thermal-shutdown and safe-area compensation, making them essentially indestructible. One of these regulators can driver up to 0.5A of output current.

FEATURES

- Suitable for CMOS, TTL and the other Digital IC's Power Supply.
- Output Current in Excess of 0.5A
- Internal Thermal Overload Protection
- Internal Short Circuit Current Limiting
- Package in the Plastic Case TO-220NIS

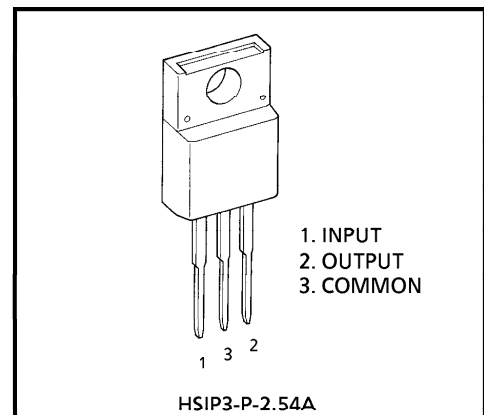

Weight : 1.7g (Typ.)

EQUIVALENT CIRCUIT

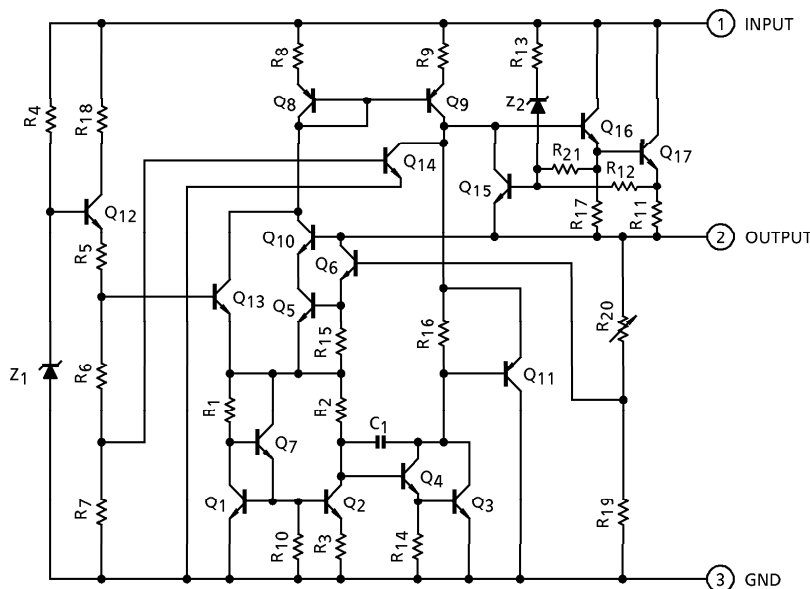

961001EBA2

● TOSHIBA is continually working to improve the quality and the reliability of its products. Nevertheless, semiconductor devices in general can malfunction or fail due to their inherent electrical sensitivity and vulnerability to physical stress. It is the responsibility of the buyer, when utilizing TOSHIBA products, to observe standards of safety, and to avoid situations in which a malfunction or failure of a TOSHIBA product could cause loss of human life, bodily injury or damage to property. In developing your designs, please ensure that TOSHIBA products are used within specified operating ranges as set forth in the most recent products specifications. Also, please keep in mind the precautions and conditions set forth in the TOSHIBA Semiconductor Reliability Handbook.

MAXIMUM RATINGS (Ta = 25°C)

CHARACTERISTIC		SYMBOL	RATING	UNIT
Input Voltage	TA78M05S	V _{IN}	35	V
	TA78M06S			
	TA78M08S			
	TA78M09S			
	TA78M10S			
	TA78M12S			
	TA78M15S			
	TA78M18S		40	
	TA78M20S			
	TA78M24S			
Power Dissipation	(Ta = 25°C)	P _D	2	W
	(Tc = 25°C)		20	
Operating Temperature		T _{opr}	- 30~75	°C
Storage Temperature		T _{stg}	- 55~150	°C
Operating Junction Temperature		T _j	- 30~150	°C
Thermal Resistance		R _{th(j-c)}	6.25	°C/W
		R _{th(j-a)}	62.5	

961001EBA2'

● The products described in this document are subject to foreign exchange and foreign trade control laws.
 ● The information contained herein is presented only as a guide for the applications of our products. No responsibility is assumed by TOSHIBA CORPORATION for any infringements of intellectual property or other rights of the third parties which may result from its use. No license is granted by implication or otherwise under any intellectual property or other rights of TOSHIBA CORPORATION or others.
 ● The information contained herein is subject to change without notice.

TA78M05S

ELECTRICAL CHARACTERISTICS

($V_{IN} = 10V$, $I_{OUT} = 350mA$, $0^{\circ}C \leq T_j \leq 125^{\circ}C$, $C_{IN} = 0.33\mu F$, $C_{OUT} = 0.1\mu F$, unless otherwise noted)

CHARACTERISTIC	SYMBOL	TEST CIR-CUIT	TEST CONDITION	MIN.	TYP.	MAX.	UNIT	
Output Voltage	V_{OUT}	1	$T_j = 25^{\circ}C$	4.8	5.0	5.2	V	
Line Regulation	Reg.line	1	$T_j = 25^{\circ}C$	$7V \leq V_{IN} \leq 25V$ $I_{OUT} = 200mA$	—	4	100	mV
				$8V \leq V_{IN} \leq 25V$ $I_{OUT} = 200mA$	—	2	50	
Load Regulation	Reg.load	1	$T_j = 25^{\circ}C$	$5mA \leq I_{OUT} \leq 500mA$	—	25	100	mV
				$5mA \leq I_{OUT} \leq 200mA$	—	10	50	
Output Voltage	V_{OUT}	1	$T_j = 25^{\circ}C$	4.75	—	5.25	V	
Quiescent Current	I_B	1	$T_j = 25^{\circ}C$	—	4.5	8.0	mA	
Quiescent Current Change	Line	1	$8.5V \leq V_{IN} \leq 25.5V$, $I_{OUT} = 200mA$	—	—	0.8	mA	
	Load	1	$5mA \leq I_{OUT} \leq 350mA$	—	—	0.5		
Output Noise Voltage	V_{NO}	2	$T_a = 25^{\circ}C$, $10Hz \leq f \leq 100kHz$	—	50	200	μV_{rms}	
Ripple Rejection	R.R.	3	$f = 120Hz$, $I_{OUT} = 100mA$ $8V \leq V_{IN} \leq 18V$, $T_j = 25^{\circ}C$	62	69	—	dB	
Short Circuit Current Limit	I_{SC}	1	$T_j = 25^{\circ}C$	—	960	—	mA	
Dropout Voltage	V_D	1	$T_a = 25^{\circ}C$	—	1.7	—	V	
Average Temperature Coefficient Of Output Voltage	T_{CVO}	1	$I_{OUT} = 5mA$	—	-0.6	—	mV / $^{\circ}C$	

TA78M06S

ELECTRICAL CHARACTERISTICS

($V_{IN} = 11V$, $I_{OUT} = 350mA$, $0^{\circ}C \leq T_j \leq 125^{\circ}C$, $C_{IN} = 0.33\mu F$, $C_{OUT} = 0.1\mu F$, unless otherwise noted)

CHARACTERISTIC	SYMBOL	TEST CIR-CUIT	TEST CONDITION	MIN.	TYP.	MAX.	UNIT	
Output Voltage	V_{OUT}	1	$T_j = 25^{\circ}C$	5.75	6.0	6.25	V	
Line Regulation	Reg.line	1	$T_j = 25^{\circ}C$	$8V \leq V_{IN} \leq 25V$ $I_{OUT} = 200mA$	—	4	100	mV
				$9V \leq V_{IN} \leq 25V$ $I_{OUT} = 200mA$	—	2	50	
Load Regulation	Reg.load	1	$T_j = 25^{\circ}C$	$5mA \leq I_{OUT} \leq 500mA$	—	25	120	mV
				$5mA \leq I_{OUT} \leq 200mA$	—	10	60	
Output Voltage	V_{OUT}	1	$T_j = 25^{\circ}C$	$8V \leq V_{IN} \leq 21V$ $5mA \leq I_{OUT} \leq 350mA$	5.7	—	6.3	V
Quiescent Current	I_B	1	$T_j = 25^{\circ}C$	—	4.5	8.0	mA	
Quiescent Current Change	Line	ΔI_B	1	$9.5V \leq V_{IN} \leq 25.5V$, $I_{OUT} = 200mA$	—	—	0.8	mA
	Load	ΔI_{BO}	1	$5mA \leq I_{OUT} \leq 350mA$	—	—	0.5	
Output Noise Voltage	V_{NO}	2	$T_a = 25^{\circ}C$, $10Hz \leq f \leq 100kHz$	—	55	220	μV_{rms}	
Ripple Rejection	R.R.	3	$f = 120Hz$, $I_{OUT} = 100mA$ $9V \leq V_{IN} \leq 19V$, $T_j = 25^{\circ}C$	59	66	—	dB	
Short Circuit Current Limit	I_{SC}	1	$T_j = 25^{\circ}C$	—	960	—	mA	
Dropout Voltage	V_D	1	$T_a = 25^{\circ}C$	—	1.7	—	V	
Average Temperature Coefficient Of Output Voltage	T_{CVO}	1	$I_{OUT} = 5mA$	—	-0.7	—	mV / $^{\circ}C$	

TA78M08S

ELECTRICAL CHARACTERISTICS

($V_{IN} = 14V$, $I_{OUT} = 350mA$, $0^{\circ}C \leq T_j \leq 125^{\circ}C$, $C_{IN} = 0.33\mu F$, $C_{OUT} = 0.1\mu F$, unless otherwise noted)

CHARACTERISTIC	SYMBOL	TEST CIR-CUIT	TEST CONDITION	MIN.	TYP.	MAX.	UNIT	
Output Voltage	V_{OUT}	1	$T_j = 25^{\circ}C$	7.7	8.0	8.3	V	
Line Regulation	Reg.line	1	$T_j = 25^{\circ}C$	$10.5V \leq V_{IN} \leq 25V$ $I_{OUT} = 200mA$	—	5	100	mV
				$11V \leq V_{IN} \leq 25V$ $I_{OUT} = 200mA$	—	3	50	
Load Regulation	Reg.load	1	$T_j = 25^{\circ}C$	$5mA \leq I_{OUT} \leq 500mA$	—	26	160	mV
				$5mA \leq I_{OUT} \leq 200mA$	—	10	80	
Output Voltage	V_{OUT}	1	$T_j = 25^{\circ}C$	$10.5V \leq V_{IN} \leq 23V$ $5mA \leq I_{OUT} \leq 350mA$	7.6	—	8.4	V
Quiescent Current	I_B	1	$T_j = 25^{\circ}C$	—	4.6	8.0	mA	
Quiescent Current Change	Line	1	$11V \leq V_{IN} \leq 25.5V$, $I_{OUT} = 200mA$	—	—	0.8	mA	
	Load	1	$5mA \leq I_{OUT} \leq 350mA$	—	—	0.5		
Output Noise Voltage	V_{NO}	2	$T_a = 25^{\circ}C$, $10Hz \leq f \leq 100kHz$	—	60	250	μV_{rms}	
Ripple Rejection	R.R.	3	$f = 120Hz$, $I_{OUT} = 100mA$ $11.5V \leq V_{IN} \leq 21.5V$, $T_j = 25^{\circ}C$	56	63	—	dB	
Short Circuit Current Limit	I_{SC}	1	$T_j = 25^{\circ}C$	—	960	—	mA	
Dropout Voltage	V_D	1	$T_a = 25^{\circ}C$	—	1.7	—	V	
Average Temperature Coefficient Of Output Voltage	T_{CVO}	1	$I_{OUT} = 5mA$	—	-1.0	—	mV / $^{\circ}C$	

TA78M09S

ELECTRICAL CHARACTERISTICS

($V_{IN} = 15V$, $I_{OUT} = 350mA$, $0^{\circ}C \leq T_j \leq 125^{\circ}C$, $C_{IN} = 0.33\mu F$, $C_{OUT} = 0.1\mu F$, unless otherwise noted)

CHARACTERISTIC	SYMBOL	TEST CIR-CUIT	TEST CONDITION	MIN.	TYP.	MAX.	UNIT	
Output Voltage	V_{OUT}	1	$T_j = 25^{\circ}C$	8.64	9.0	9.36	V	
Line Regulation	Reg.line	1	$T_j = 25^{\circ}C$	$11.5V \leq V_{IN} \leq 26V$ $I_{OUT} = 200mA$	—	5	100	mV
				$13V \leq V_{IN} \leq 26V$ $I_{OUT} = 200mA$	—	3	50	
Load Regulation	Reg.load	1	$T_j = 25^{\circ}C$	$5mA \leq I_{OUT} \leq 500mA$	—	26	180	mV
				$5mA \leq I_{OUT} \leq 200mA$	—	10	90	
Output Voltage	V_{OUT}	1	$T_j = 25^{\circ}C$	$11.5V \leq V_{IN} \leq 24V$ $5mA \leq I_{OUT} \leq 350mA$	8.55	—	9.45	V
Quiescent Current	I_B	1	$T_j = 25^{\circ}C$	—	4.6	8.0	mA	
Quiescent Current Change	Line	1	$12V \leq V_{IN} \leq 26.5V$, $I_{OUT} = 200mA$	—	—	0.8	mA	
	Load							$5mA \leq I_{OUT} \leq 350mA$
Output Noise Voltage	V_{NO}	2	$T_a = 25^{\circ}C$, $10Hz \leq f \leq 100kHz$	—	60	270	μV_{rms}	
Ripple Rejection	R.R.	3	$f = 120Hz$, $I_{OUT} = 100mA$ $12.5V \leq V_{IN} \leq 22.5V$, $T_j = 25^{\circ}C$	56	63	—	dB	
Short Circuit Current Limit	I_{SC}	1	$T_j = 25^{\circ}C$	—	960	—	mA	
Dropout Voltage	V_D	1	$T_a = 25^{\circ}C$	—	1.7	—	V	
Average Temperature Coefficient Of Output Voltage	T_{CVO}	1	$I_{OUT} = 5mA$	—	-1.1	—	mV / $^{\circ}C$	

TA78M10S

ELECTRICAL CHARACTERISTICS

($V_{IN} = 16V$, $I_{OUT} = 350mA$, $0^{\circ}C \leq T_j \leq 125^{\circ}C$, $C_{IN} = 0.33\mu F$, $C_{OUT} = 0.1\mu F$, unless otherwise noted)

CHARACTERISTIC	SYMBOL	TEST CIR-CUIT	TEST CONDITION	MIN.	TYP.	MAX.	UNIT	
Output Voltage	V_{OUT}	1	$T_j = 25^{\circ}C$	9.6	10.0	10.4	V	
Line Regulation	Reg.line	1	$T_j = 25^{\circ}C$	$12.5V \leq V_{IN} \leq 26V$ $I_{OUT} = 200mA$	—	6	100	mV
				$14V \leq V_{IN} \leq 26V$ $I_{OUT} = 200mA$	—	3	50	
Load Regulation	Reg.load	1	$T_j = 25^{\circ}C$	$5mA \leq I_{OUT} \leq 500mA$	—	26	200	mV
				$5mA \leq I_{OUT} \leq 200mA$	—	10	100	
Output Voltage	V_{OUT}	1	$T_j = 25^{\circ}C$	9.5	—	10.5	V	
Quiescent Current	I_B	1	$T_j = 25^{\circ}C$	—	4.7	8.0	mA	
Quiescent Current Change	Line	1	$13V \leq V_{IN} \leq 26.5V$, $I_{OUT} = 200mA$	—	—	0.8	mA	
	Load	1	$5mA \leq I_{OUT} \leq 350mA$	—	—	0.5		
Output Noise Voltage	V_{NO}	2	$T_a = 25^{\circ}C$, $10Hz \leq f \leq 100kHz$	—	65	280	μV_{rms}	
Ripple Rejection	R.R.	3	$f = 120Hz$, $I_{OUT} = 100mA$ $13.5V \leq V_{IN} \leq 23.5V$, $T_j = 25^{\circ}C$	55	62	—	dB	
Short Circuit Current Limit	I_{SC}	1	$T_j = 25^{\circ}C$	—	960	—	mA	
Dropout Voltage	V_D	1	$T_a = 25^{\circ}C$	—	1.7	—	V	
Average Temperature Coefficient Of Output Voltage	T_{CVO}	1	$I_{OUT} = 5mA$	—	-1.3	—	mV / $^{\circ}C$	

TA78M12S

ELECTRICAL CHARACTERISTICS

($V_{IN} = 19V$, $I_{OUT} = 350mA$, $0^{\circ}C \leq T_j \leq 125^{\circ}C$, $C_{IN} = 0.33\mu F$, $C_{OUT} = 0.1\mu F$, unless otherwise noted)

CHARACTERISTIC	SYMBOL	TEST CIR-CUIT	TEST CONDITION	MIN.	TYP.	MAX.	UNIT	
Output Voltage	V_{OUT}	1	$T_j = 25^{\circ}C$	11.5	12.0	12.5	V	
Line Regulation	Reg.line	1	$T_j = 25^{\circ}C$	$14.5V \leq V_{IN} \leq 30V$ $I_{OUT} = 200mA$	—	7	100	mV
				$16V \leq V_{IN} \leq 30V$ $I_{OUT} = 200mA$	—	3	50	
Load Regulation	Reg.load	1	$T_j = 25^{\circ}C$	$5mA \leq I_{OUT} \leq 500mA$	—	27	240	mV
				$5mA \leq I_{OUT} \leq 200mA$	—	10	120	
Output Voltage	V_{OUT}	1	$T_j = 25^{\circ}C$	$14.5V \leq V_{IN} \leq 27V$ $5mA \leq I_{OUT} \leq 350mA$	11.4	—	12.6	V
Quiescent Current	I_B	1	$T_j = 25^{\circ}C$	—	4.8	8.0	mA	
Quiescent Current Change	Line	1	$15V \leq V_{IN} \leq 30.5V$, $I_{OUT} = 200mA$	—	—	0.8	mA	
	Load			$5mA \leq I_{OUT} \leq 350mA$	—	—		0.5
Output Noise Voltage	V_{NO}	2	$T_a = 25^{\circ}C$, $10Hz \leq f \leq 100kHz$	—	70	300	μV_{rms}	
Ripple Rejection	R.R.	3	$f = 120Hz$, $I_{OUT} = 100mA$ $15V \leq V_{IN} \leq 25V$, $T_j = 25^{\circ}C$	55	62	—	dB	
Short Circuit Current Limit	I_{SC}	1	$T_j = 25^{\circ}C$	—	960	—	mA	
Dropout Voltage	V_D	1	$T_a = 25^{\circ}C$	—	1.7	—	V	
Average Temperature Coefficient Of Output Voltage	T_{CVO}	1	$I_{OUT} = 5mA$	—	-1.6	—	mV / $^{\circ}C$	

TA78M15S

ELECTRICAL CHARACTERISTICS

($V_{IN} = 23V$, $I_{OUT} = 350mA$, $0^{\circ}C \leq T_j \leq 125^{\circ}C$, $C_{IN} = 0.33\mu F$, $C_{OUT} = 0.1\mu F$, unless otherwise noted)

CHARACTERISTIC	SYMBOL	TEST CIR-CUIT	TEST CONDITION	MIN.	TYP.	MAX.	UNIT	
Output Voltage	V_{OUT}	1	$T_j = 25^{\circ}C$	14.4	15.0	15.6	V	
Line Regulation	Reg.line	1	$T_j = 25^{\circ}C$	$17.5V \leq V_{IN} \leq 30V$ $I_{OUT} = 200mA$	—	8	100	mV
				$20V \leq V_{IN} \leq 30V$ $I_{OUT} = 200mA$	—	4	50	
Load Regulation	Reg.load	1	$T_j = 25^{\circ}C$	$5mA \leq I_{OUT} \leq 500mA$	—	27	300	mV
				$5mA \leq I_{OUT} \leq 200mA$	—	10	150	
Output Voltage	V_{OUT}	1	$T_j = 25^{\circ}C$	14.25	—	15.75	V	
Quiescent Current	I_B	1	$T_j = 25^{\circ}C$	—	4.8	8.0	mA	
Quiescent Current Change	Line	1	$18V \leq V_{IN} \leq 30.5V$, $I_{OUT} = 200mA$	—	—	0.8	mA	
	Load	1	$5mA \leq I_{OUT} \leq 350mA$	—	—	0.5		
Output Noise Voltage	V_{NO}	2	$T_a = 25^{\circ}C$, $10Hz \leq f \leq 100kHz$	—	80	450	μV_{rms}	
Ripple Rejection	R.R.	3	$f = 120Hz$, $I_{OUT} = 100mA$ $18.5V \leq V_{IN} \leq 28.5V$, $T_j = 25^{\circ}C$	54	61	—	dB	
Short Circuit Current Limit	I_{SC}	1	$T_j = 25^{\circ}C$	—	960	—	mA	
Dropout Voltage	V_D	1	$T_a = 25^{\circ}C$	—	1.7	—	V	
Average Temperature Coefficient Of Output Voltage	T_{CVO}	1	$I_{OUT} = 5mA$	—	-2.0	—	mV / $^{\circ}C$	

TA78M18S

ELECTRICAL CHARACTERISTICS

($V_{IN} = 27V$, $I_{OUT} = 350mA$, $0^{\circ}C \leq T_j \leq 125^{\circ}C$, $C_{IN} = 0.33\mu F$, $C_{OUT} = 0.1\mu F$, unless otherwise noted)

CHARACTERISTIC	SYMBOL	TEST CIR-CUIT	TEST CONDITION	MIN.	TYP.	MAX.	UNIT	
Output Voltage	V_{OUT}	1	$T_j = 25^{\circ}C$	17.3	18.0	18.7	V	
Line Regulation	Reg.line	1	$T_j = 25^{\circ}C$	$21V \leq V_{IN} \leq 33V$ $I_{OUT} = 200mA$	—	9	100	mV
				$24V \leq V_{IN} \leq 33V$ $I_{OUT} = 200mA$	—	5	50	
Load Regulation	Reg.load	1	$T_j = 25^{\circ}C$	$5mA \leq I_{OUT} \leq 500mA$	—	28	360	mV
				$5mA \leq I_{OUT} \leq 200mA$	—	10	180	
Output Voltage	V_{OUT}	1	$T_j = 25^{\circ}C$	$21V \leq V_{IN} \leq 33V$ $5mA \leq I_{OUT} \leq 350mA$	17.1	—	18.9	V
Quiescent Current	I_B	1	$T_j = 25^{\circ}C$	—	4.8	8.0	mA	
Quiescent Current Change	Line	ΔI_B	1	$21.5V \leq V_{IN} \leq 33.5V$, $I_{OUT} = 200mA$	—	—	0.8	mA
	Load	ΔI_{BO}	1	$5mA \leq I_{OUT} \leq 350mA$	—	—	0.5	
Output Noise Voltage	V_{NO}	2	$T_a = 25^{\circ}C$, $10Hz \leq f \leq 100kHz$	—	90	490	μV_{rms}	
Ripple Rejection	R.R.	3	$f = 120Hz$, $I_{OUT} = 100mA$ $22V \leq V_{IN} \leq 32V$, $T_j = 25^{\circ}C$	53	60	—	dB	
Short Circuit Current Limit	I_{SC}	1	$T_j = 25^{\circ}C$	—	960	—	mA	
Dropout Voltage	V_D	1	$T_a = 25^{\circ}C$	—	1.7	—	V	
Average Temperature Coefficient Of Output Voltage	T_{CVO}	1	$I_{OUT} = 5mA$	—	-2.5	—	mV / $^{\circ}C$	

TA78M20S

ELECTRICAL CHARACTERISTICS

($V_{IN} = 29V$, $I_{OUT} = 350mA$, $0^{\circ}C \leq T_j \leq 125^{\circ}C$, $C_{IN} = 0.33\mu F$, $C_{OUT} = 0.1\mu F$, unless otherwise noted)

CHARACTERISTIC	SYMBOL	TEST CIR-CUIT	TEST CONDITION	MIN.	TYP.	MAX.	UNIT	
Output Voltage	V_{OUT}	1	$T_j = 25^{\circ}C$	19.2	20.0	20.8	V	
Line Regulation	Reg.line	1	$T_j = 25^{\circ}C$	$23V \leq V_{IN} \leq 35V$ $I_{OUT} = 200mA$	—	10	100	mV
				$24V \leq V_{IN} \leq 35V$ $I_{OUT} = 200mA$	—	6	50	
Load Regulation	Reg.load	1	$T_j = 25^{\circ}C$	$5mA \leq I_{OUT} \leq 500mA$	—	28	400	mV
				$5mA \leq I_{OUT} \leq 200mA$	—	10	200	
Output Voltage	V_{OUT}	1	$T_j = 25^{\circ}C$	$23V \leq V_{IN} \leq 35V$ $5mA \leq I_{OUT} \leq 350mA$	19.0	—	21.0	V
Quiescent Current	I_B	1	$T_j = 25^{\circ}C$	—	4.9	8.0	mA	
Quiescent Current Change	Line	ΔI_B	1	$23.5V \leq V_{IN} \leq 35.5V$, $I_{OUT} = 200mA$	—	—	0.8	mA
	Load	ΔI_{BO}	1	$5mA \leq I_{OUT} \leq 350mA$	—	—	0.5	
Output Noise Voltage	V_{NO}	2	$T_a = 25^{\circ}C$, $10Hz \leq f \leq 100kHz$	—	95	540	μV_{rms}	
Ripple Rejection	R.R.	3	$f = 120Hz$, $I_{OUT} = 100mA$ $24V \leq V_{IN} \leq 34V$, $T_j = 25^{\circ}C$	53	60	—	dB	
Short Circuit Current Limit	I_{SC}	1	$T_j = 25^{\circ}C$	—	960	—	mA	
Dropout Voltage	V_D	1	$T_a = 25^{\circ}C$	—	1.7	—	V	
Average Temperature Coefficient Of Output Voltage	T_{CVO}	1	$I_{OUT} = 5mA$	—	-3.0	—	mV / $^{\circ}C$	

TA78M24S

ELECTRICAL CHARACTERISTICS

($V_{IN} = 33V$, $I_{OUT} = 350mA$, $0^{\circ}C \leq T_j \leq 125^{\circ}C$, $C_{IN} = 0.33\mu F$, $C_{OUT} = 0.1\mu F$, unless otherwise noted)

CHARACTERISTIC	SYMBOL	TEST CIR-CUIT	TEST CONDITION	MIN.	TYP.	MAX.	UNIT	
Output Voltage	V_{OUT}	1	$T_j = 25^{\circ}C$	23.0	24.0	25.0	V	
Line Regulation	Reg.line	1	$T_j = 25^{\circ}C$	$27V \leq V_{IN} \leq 38V$ $I_{OUT} = 200mA$	—	12	100	mV
				$28V \leq V_{IN} \leq 38V$ $I_{OUT} = 200mA$	—	7	50	
Load Regulation	Reg.load	1	$T_j = 25^{\circ}C$	$5mA \leq I_{OUT} \leq 500mA$	—	30	480	mV
				$5mA \leq I_{OUT} \leq 200mA$	—	10	240	
Output Voltage	V_{OUT}	1	$T_j = 25^{\circ}C$	22.8	—	25.2	V	
Quiescent Current	I_B	1	$T_j = 25^{\circ}C$	—	5.0	8.0	mA	
Quiescent Current Change	Line	1	$27.5V \leq V_{IN} \leq 38.5V$, $I_{OUT} = 200mA$	—	—	0.8	mA	
	Load	1	$5mA \leq I_{OUT} \leq 350mA$	—	—	0.5		
Output Noise Voltage	V_{NO}	2	$T_a = 25^{\circ}C$, $10Hz \leq f \leq 100kHz$	—	115	650	μV_{rms}	
Ripple Rejection	R.R.	3	$f = 120Hz$, $I_{OUT} = 100mA$ $28V \leq V_{IN} \leq 38V$, $T_j = 25^{\circ}C$	50	57	—	dB	
Short Circuit Current Limit	I_{SC}	1	$T_j = 25^{\circ}C$	—	960	—	mA	
Dropout Voltage	V_D	1	$T_a = 25^{\circ}C$	—	1.7	—	V	
Average Temperature Coefficient Of Output Voltage	T_{CVO}	1	$I_{OUT} = 5mA$	—	-3.5	—	mV / $^{\circ}C$	

TEST CIRCUIT 1 / STANDARD APPLICATION

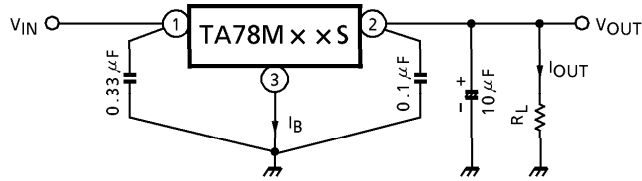

TEST CIRCUIT 2 V_{NO}

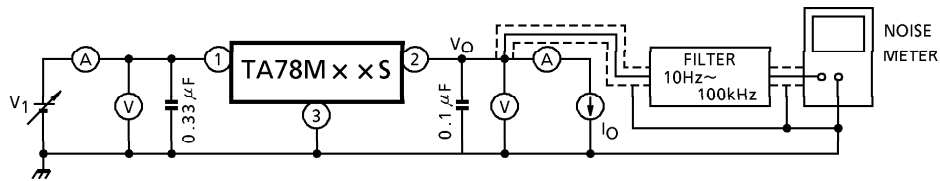

TEST CIRCUIT 3 R.R.

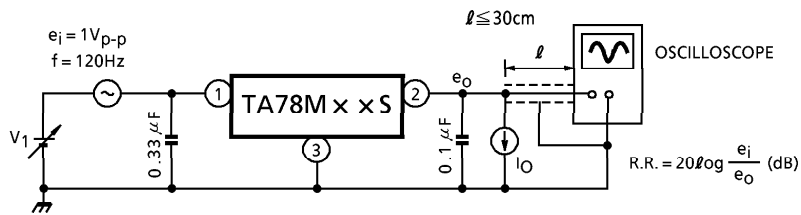

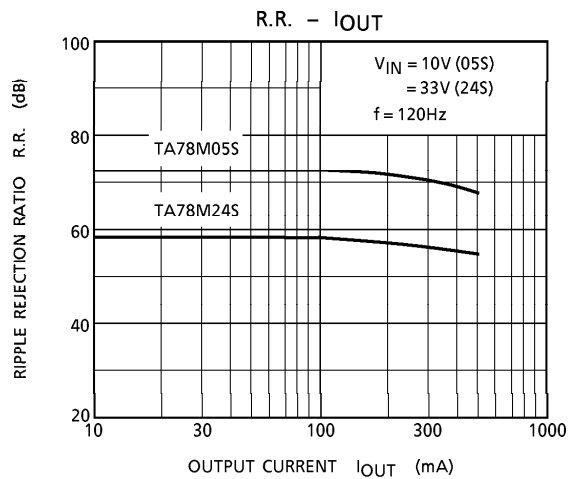
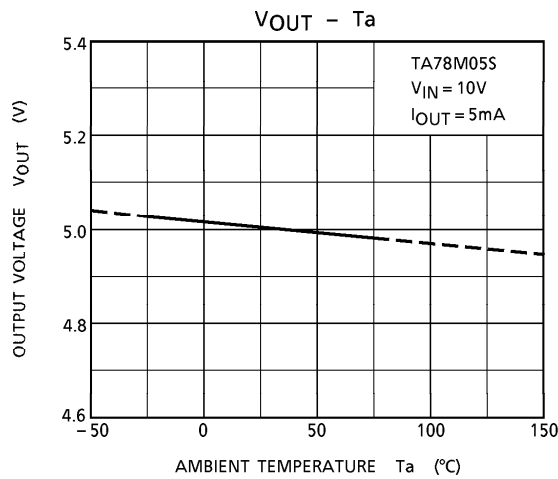
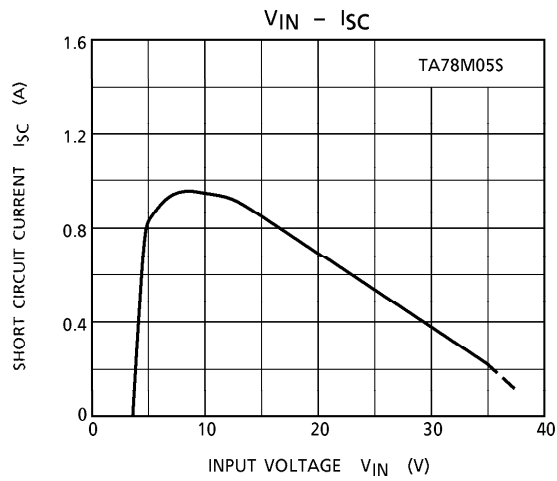
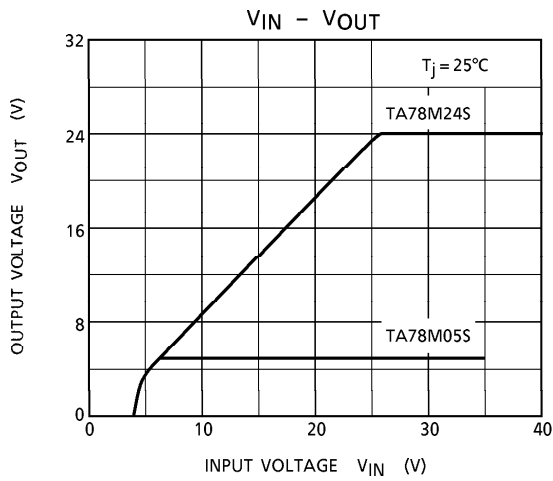
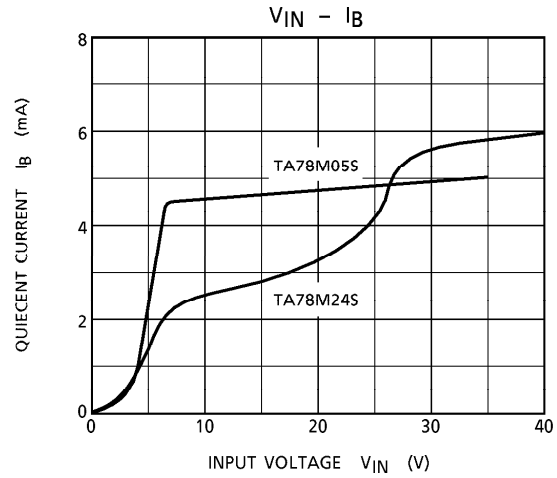
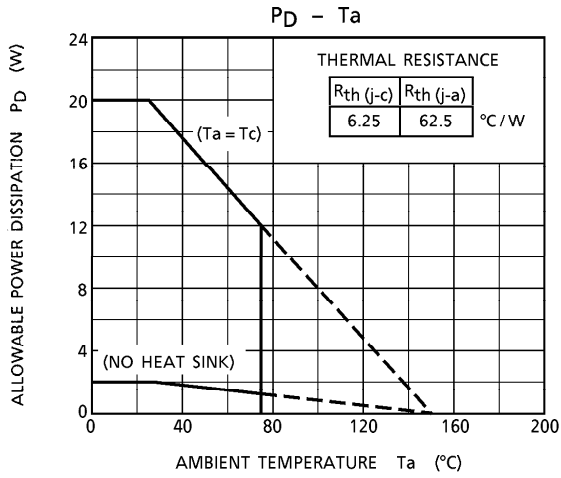

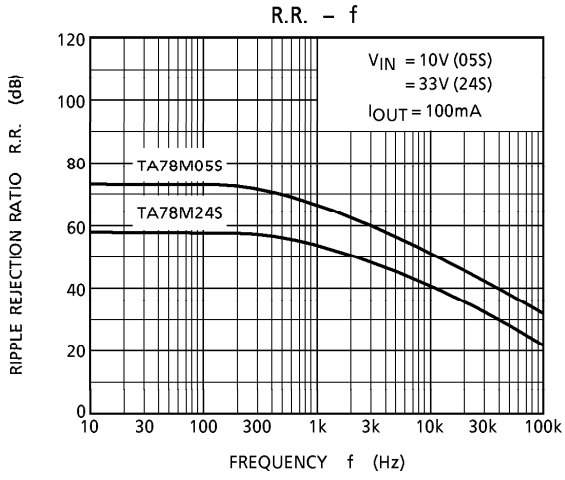

PRECAUTIONS ON APPLICATION

- (1) In regard to GND, be careful not to apply a negative voltage to the input/output terminal. Further, special care is necessary in case of a voltage boost application.
- (2) When a surge voltage exceeding maximum rating is applied to the input terminal or when a voltage in excess of the input terminal voltage is applied to the output terminal, the circuit may be destroyed.

Specially, in the latter case, great care is necessary.

Further, if the input terminal sorts to GND in a state of normal operation, the output terminal voltage becomes higher than the input voltage (GND potential), and the electric charge of a chemical capacitor connected to the output terminal flows into the input side, which may cause the destruction of circuit.

In these cases, take such steps as a zener diode and a general silicon diode are connected to the circuit, as shown in the following figure.

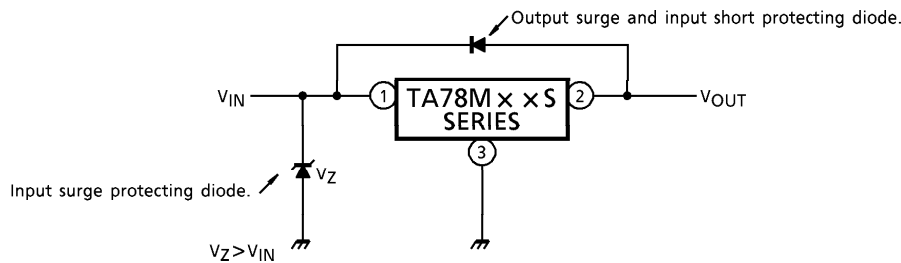

- (3) When the input voltage is too high, the power dissipation of three terminal regulator increases because of series regulator, so that the junction temperature rises. In such a case, it is recommended to reduce the power dissipation by inserting the power limiting resistor R_{SD} in the input terminal, and to reduce the junction temperature as a result.

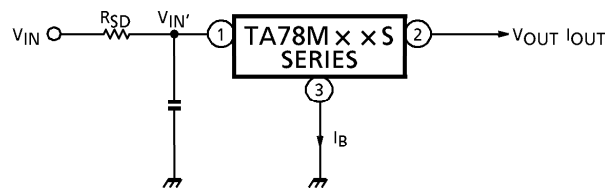

The power dissipation P_D of IC is expressed in the following equation.

$$P_D = (V_{IN'} - V_{OUT}) \cdot I_{OUT} + V_{IN'} \cdot I_B$$

If $V_{IN'}$ is reduced below the lowest voltage necessary for the IC, the parasitic oscillation will be caused according to circumstances.

In determining the resistance value of R_{SD} , design with margin should be made by making reference to the following equation.

$$R_{SD} < \frac{V_{IN} - V_{IN'}}{I_{OUT} + I_B}$$

- (4) Connect the input terminal and GND, and the output terminal and GND, by capacitor respectively. The capacitances should be determined experimentally because they depend on printed patterns. In particular, adequate investigation should be made so that there is no problem even at time of high or low temperature.
- (5) Installation of IC for power supply
 For obtaining high reliability on the heat sink design of the regulator IC, it is generally required to derate more than 20% of maximum junction temperature (T_j MAX.).
 Further, full consideration should be given to the installation of IC to the heat sink.

(a) Heat sink design

The thermal resistance of IC itself is required from the viewpoint of the design of elements, but the thermal resistance from the IC package to the open air varies with the contact thermal resistance.

Table 1 shows how much the value of the contact thermal resistance ($\theta_c + \theta_s$) is changed by heat sink grease.

TABLE 1

Unit : °C/W

PACKAGE	MODEL No.	TORQUE	MICA	$\theta_c + \theta_s$
TO-220NIS	TA78M × ×S	0.6N·m	Not Provided	0.3~0.5 (1.5~2.0)

The figures given in parentheses denote the values at time of no grease.

(b) Silicon grease

When a circuit not exceeding maximum rating is designed, it is to be desired that the grease should be used if possible. If it is required that the contact thermal resistance is reduced from the viewpoint of the circuit design, it is recommended that the following methods be adopted.

A : Use YG6260 (TOSHIBA SILICON CORPORATION), if grease is used.

(c) Torque

When installing IC on a heat sink or the like, tighten the IC with the torque of less than the rated value. If it is tightened with the torque in excess of the rated value, sometimes the internal elements of the IC are adversely affected. Therefore, great care should be given to the installing operation.

APPLICATION CIRCUITS

(1) VOLTAGE BOOST REGULATOR

(a) Voltage boost by use of zener diode

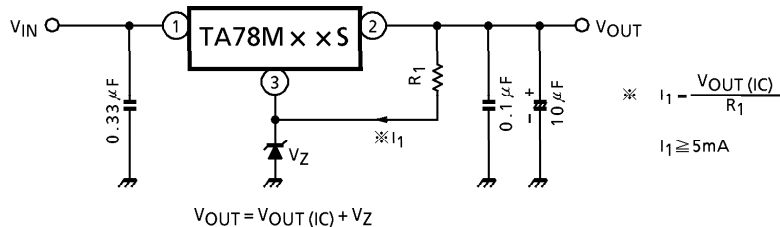

(b) Voltage boost by use of resistor

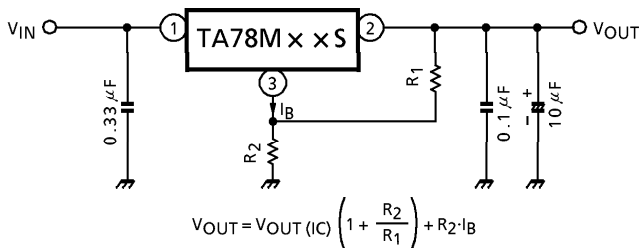

(c) Adjustable output regulator

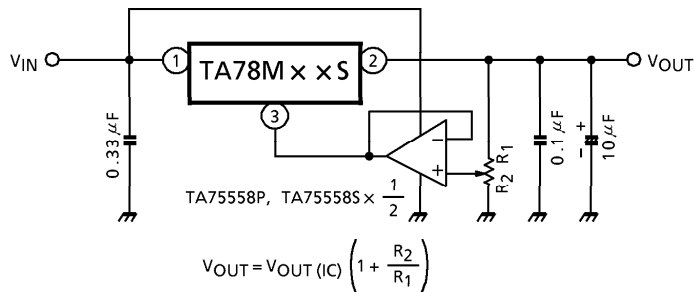

(2) CURRENT BOOST REGULATOR

(a) CURRENT BOOST VOLTAGE REGULATOR

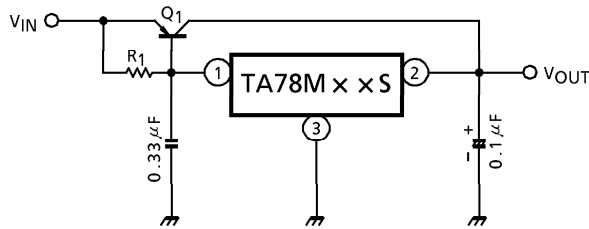

Heat sink is needed for Q1

$$R_1 \cong \frac{V_{BE1}}{I_B \text{ MAX}}$$

where,

V_{BE1} : V_{BE} of external transistor Q1.

$I_B \text{ MAX}$: Quiescent current of IC.

(b) SHORT-CIRCUIT PROTECTION

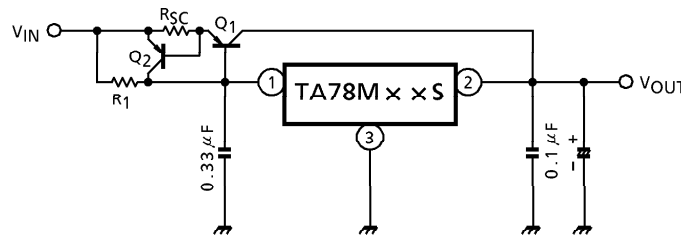

$$R_{SC} = \frac{V_{BE2}}{I_{SC}}$$

where,

I_{SC} : Short-circuit current

(3) NEGATIVE REGULATOR

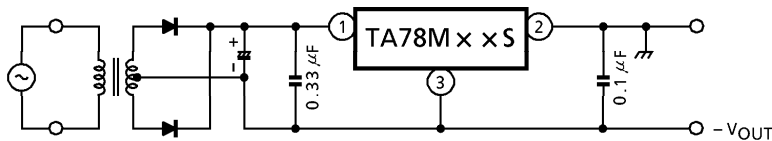

(4) POSITIVE AND NEGATIVE REGULATOR

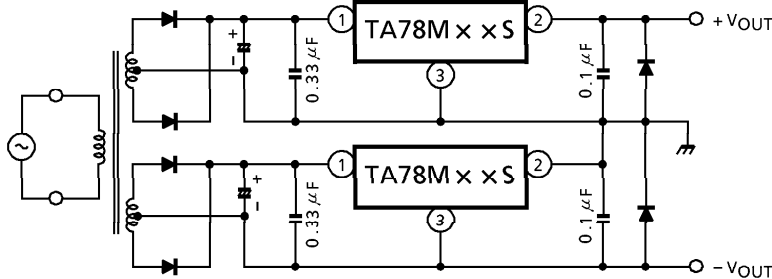

(5) CURRENT REGULATOR

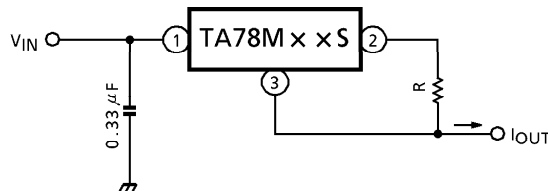

$$I_{OUT} = \frac{V_{OUT}}{R} + I_B$$

OUTLINE DRAWING
HSIP3-P-2.54A

Unit : mm

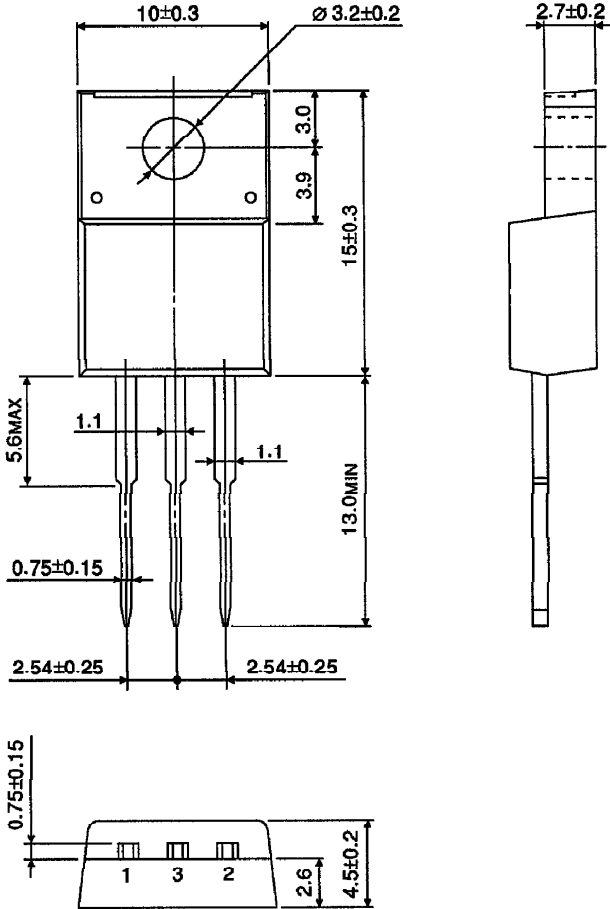

Weight : 1.7g (Typ.)