

DATA SHEET

BFS17W

NPN 1 GHz wideband transistor

Product specification
Supersedes data of November 1992
File under discrete semiconductors, SC14

1995 Sep 04

NPN 1 GHz wideband transistor

BFS17W

APPLICATIONS

Primarily intended as a mixer, oscillator and IF amplifier in UHF and VHF tuners.

DESCRIPTION

Silicon NPN transistor in a plastic SOT323 (S-mini) package. The BFS17W uses the same crystal as the SOT23 version, BFS17.

PINNING

PIN	DESCRIPTION
1	base
2	emitter
3	collector

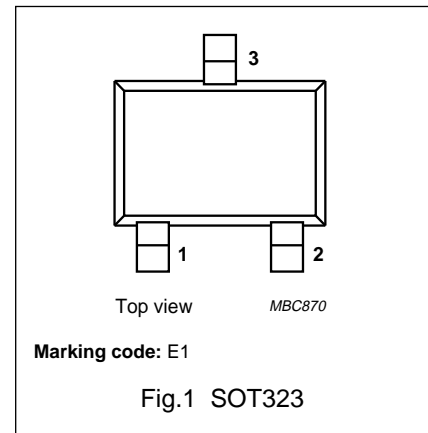

QUICK REFERENCE DATA

SYMBOL	PARAMETER	CONDITIONS	MIN.	TYP.	MAX.	UNIT
V_{CBO}	collector-base voltage		–	–	25	V
V_{CEO}	collector-emitter voltage		–	–	15	V
I_C	DC collector current		–	–	50	mA
P_{tot}	total power dissipation	up to $T_s = 118\text{ °C}$; note 1	–	–	300	mW
h_{FE}	DC current gain	$I_C = 2\text{ mA}$; $V_{CE} = 1\text{ V}$	25	90	–	
f_T	transition frequency	$I_C = 25\text{ mA}$; $V_{CE} = 5\text{ V}$	–	1.6	–	GHz
C_c	collector capacitance	$I_E = 0$; $V_{CB} = 10\text{ V}$; $f = 1\text{ MHz}$	–	0.8	1.5	pF
C_{re}	feedback capacitance	$I_C = 1\text{ mA}$; $V_{CE} = 5\text{ V}$; $f = 1\text{ MHz}$	–	0.75	–	pF
T_j	junction temperature		–	–	175	°C

Note

- T_s is the temperature at the soldering point of the collector pin.

LIMITING VALUES

In accordance with the Absolute Maximum Rating System (IEC 134).

SYMBOL	PARAMETER	CONDITIONS	MIN.	MAX.	UNIT
V_{CBO}	collector-base voltage	open emitter	–	25	V
V_{CEO}	collector-emitter voltage	open base	–	15	V
V_{EBO}	emitter-base voltage	open collector	–	2.5	V
I_C	collector current (DC)		–	50	mA
P_{tot}	total power dissipation	$T_s = 118\text{ °C}$; note 1	–	300	mW
T_{stg}	storage temperature		–65	+150	°C
T_j	junction temperature		–	175	°C

Note

- T_s is the temperature at the soldering point of the collector pin.

NPN 1 GHz wideband transistor

BFS17W

THERMAL CHARACTERISTICS

SYMBOL	PARAMETER	CONDITIONS	VALUE	UNIT
$R_{th\ j-s}$	thermal resistance from junction to soldering point	up to $T_s = 118\text{ }^\circ\text{C}$; note 1	190	K/W

Note

- T_s is the temperature at the soldering point of the collector pin.

CHARACTERISTICS

$T_j = 25\text{ }^\circ\text{C}$ (unless otherwise specified).

SYMBOL	PARAMETER	CONDITIONS	MIN.	TYP.	MAX.	UNIT
I_{CBO}	collector cut-off current	$I_E = 0; V_{CB} = 10\text{ V}$	–	–	10	nA
h_{FE}	DC current gain	$I_C = 2\text{ mA}; V_{CE} = 1\text{ V}$	25	90	–	
f_T	transition frequency	$I_C = 25\text{ mA}; V_{CE} = 5\text{ V}; f = 500\text{ MHz}$	–	1.6	–	GHz
C_c	collector capacitance	$I_E = i_e = 0; V_{CB} = 10\text{ V}; f = 1\text{ MHz}$	–	0.8	1.5	pF
C_e	emitter capacitance	$I_C = i_c = 0; V_{EB} = 0.5\text{ V}; f = 1\text{ MHz}$	–	2	–	pF
C_{re}	feedback capacitance	$I_B = i_b = 0; V_{CE} = 5\text{ V}; f = 1\text{ MHz}; T_{amb} = 25\text{ }^\circ\text{C}$	–	0.75	–	pF
F	noise figure	$I_C = 2\text{ mA}; V_{CE} = 5\text{ V}; f = 500\text{ MHz}; \Gamma_S = \Gamma_{opt}$	–	4.5	–	dB

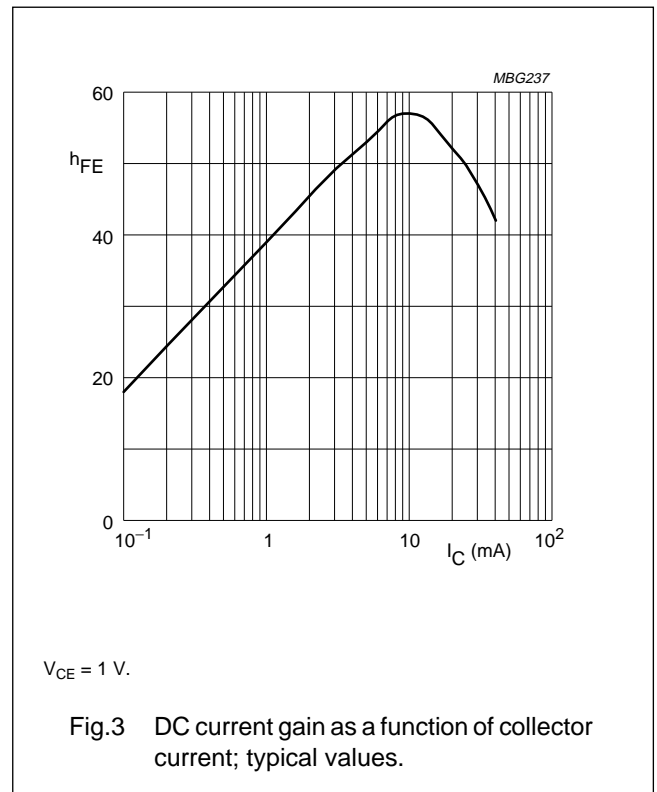
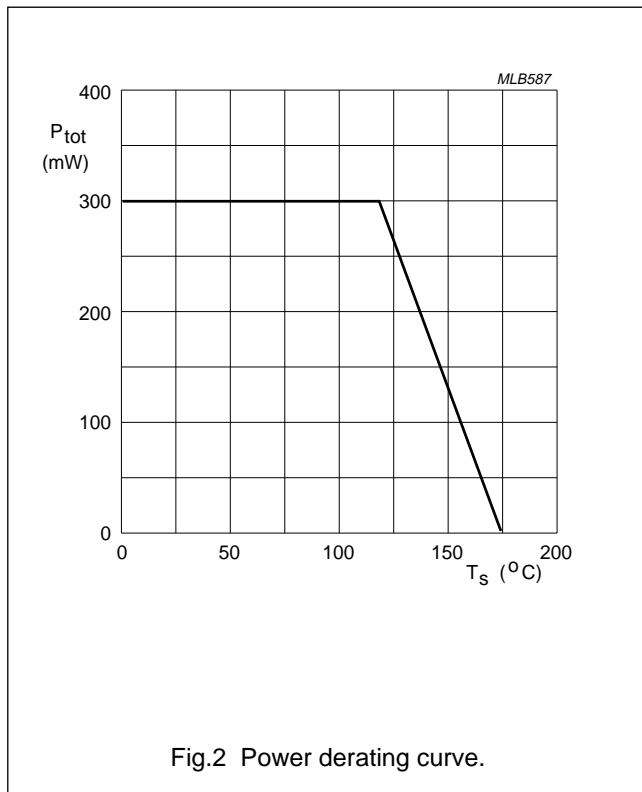

NPN 1 GHz wideband transistor

BFS17W

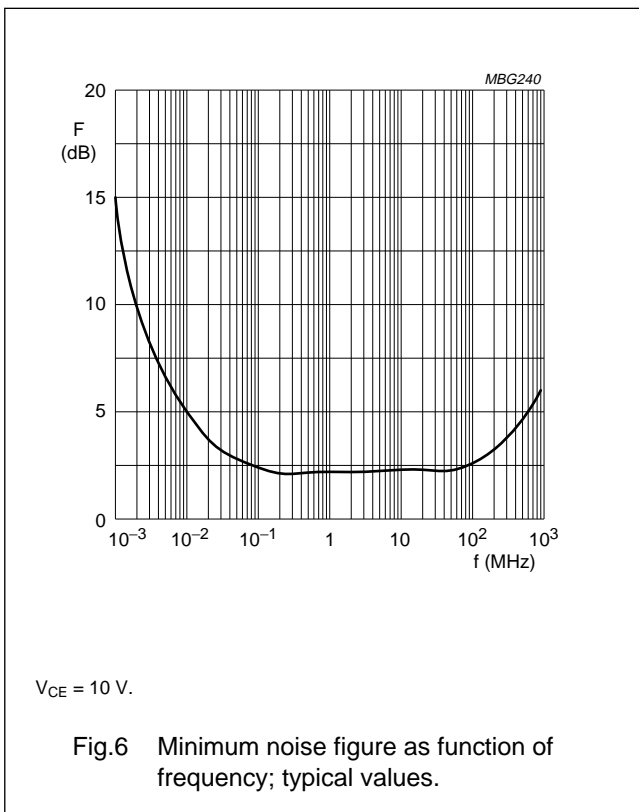
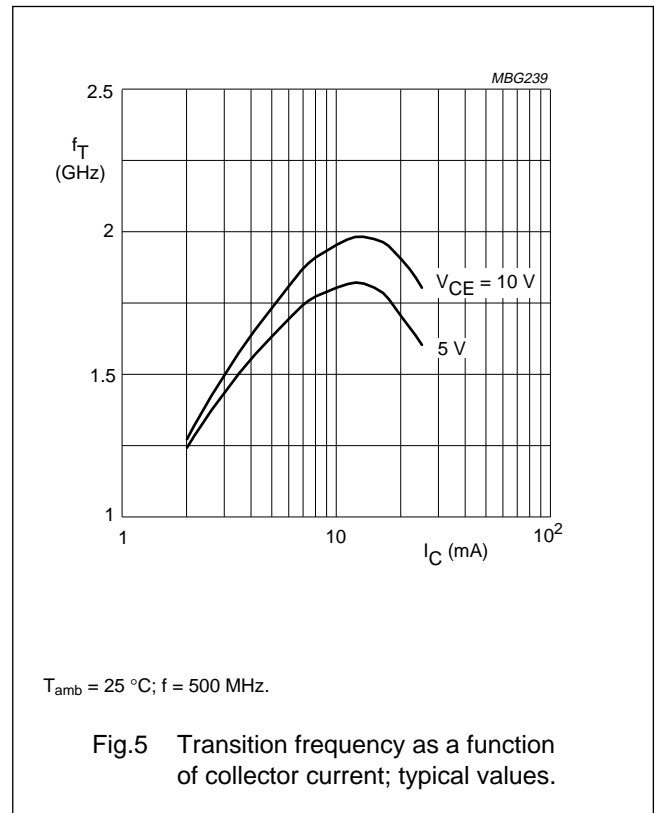
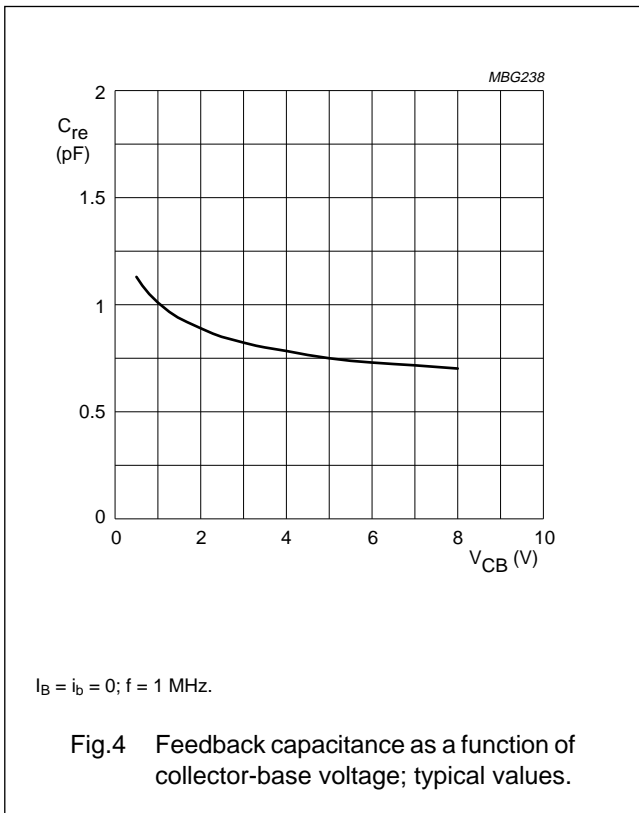

NPN 1 GHz wideband transistor

BFS17W

PACKAGE OUTLINE

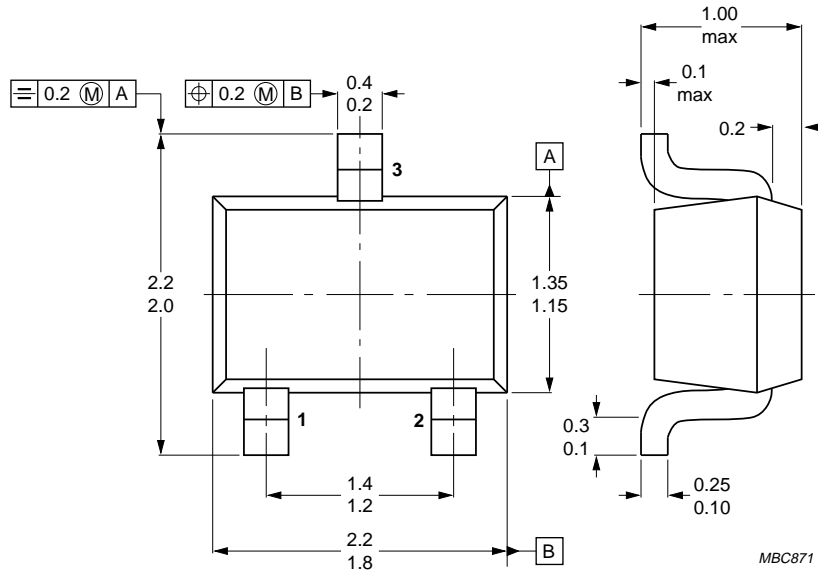

Dimensions in mm.

Fig.7 SOT323.

NPN 1 GHz wideband transistor

BFS17W

DEFINITIONS

Data sheet status	
Objective specification	This data sheet contains target or goal specifications for product development.
Preliminary specification	This data sheet contains preliminary data; supplementary data may be published later.
Product specification	This data sheet contains final product specifications.
Limiting values	
Limiting values given are in accordance with the Absolute Maximum Rating System (IEC 134). Stress above one or more of the limiting values may cause permanent damage to the device. These are stress ratings only and operation of the device at these or at any other conditions above those given in the Characteristics sections of the specification is not implied. Exposure to limiting values for extended periods may affect device reliability.	
Application information	
Where application information is given, it is advisory and does not form part of the specification.	

LIFE SUPPORT APPLICATIONS

These products are not designed for use in life support appliances, devices, or systems where malfunction of these products can reasonably be expected to result in personal injury. Philips customers using or selling these products for use in such applications do so at their own risk and agree to fully indemnify Philips for any damages resulting from such improper use or sale.