

# DTC114EET1 Series

## Bias Resistor Transistor

### NPN Silicon Surface Mount Transistor with Monolithic Bias Resistor Network

This new series of digital transistors is designed to replace a single device and its external resistor bias network. The BRT (Bias Resistor Transistor) contains a single transistor with a monolithic bias network consisting of two resistors; a series base resistor and a base-emitter resistor. The BRT eliminates these individual components by integrating them into a single device. The use of a BRT can reduce both system cost and board space. The device is housed in the SC-75/SOT-416 package which is designed for low power surface mount applications.

#### Features

- Simplifies Circuit Design
- Reduces Board Space
- Reduces Component Count
- The SC-75/SOT-416 Package Can be Soldered Using Wave or Reflow
- The Modified Gull-Winged Leads Absorb Thermal Stress During Soldering Eliminating the Possibility of Damage to the Die
- Available in 8 mm, 7 inch/3000 Unit Tape & Reel
- Pb-Free Packages are Available

#### MAXIMUM RATINGS ( $T_A = 25^\circ\text{C}$ unless otherwise noted)

| Rating                    | Symbol    | Value | Unit |
|---------------------------|-----------|-------|------|
| Collector-Base Voltage    | $V_{CB0}$ | 50    | Vdc  |
| Collector-Emitter Voltage | $V_{CEO}$ | 50    | Vdc  |
| Collector Current         | $I_C$     | 100   | mAdc |

Maximum ratings are those values beyond which device damage can occur. Maximum ratings applied to the device are individual stress limit values (not normal operating conditions) and are not valid simultaneously. If these limits are exceeded, device functional operation is not implied, damage may occur and reliability may be affected.

#### THERMAL CHARACTERISTICS

| Rating   | Symbol          | Value          | Unit                       |
|--|-----------------|----------------|----------------------------|
| Total Device Dissipation,<br>FR-4 Board (Note 1) @ $T_A = 25^\circ\text{C}$<br>Derate above $25^\circ\text{C}$ | $P_D$           | 200<br>1.6     | mW<br>mW/ $^\circ\text{C}$ |
| Thermal Resistance,<br>Junction-to-Ambient (Note 1)  | $R_{\theta JA}$ | 600            | $^\circ\text{C}/\text{W}$  |
| Total Device Dissipation,<br>FR-4 Board (Note 2) @ $T_A = 25^\circ\text{C}$<br>Derate above $25^\circ\text{C}$ | $P_D$           | 300<br>2.4     | mW<br>mW/ $^\circ\text{C}$ |
| Thermal Resistance,<br>Junction-to-Ambient (Note 2)  | $R_{\theta JA}$ | 400            | $^\circ\text{C}/\text{W}$  |
| Junction and Storage Temperature Range   | $T_J, T_{stg}$  | -55 to<br>+150 | $^\circ\text{C}$           |

1. FR-4 @ Minimum Pad
2. FR-4 @  $1.0 \times 1.0$  Inch Pad



ON Semiconductor®

<http://onsemi.com>

## NPN SILICON BIAS RESISTOR TRANSISTORS

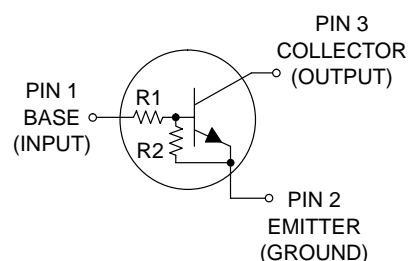

#### MARKING DIAGRAM

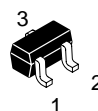

SC-75/SOT-416  
CASE 463  
STYLE 1

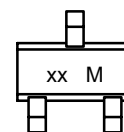

xx = Specific Device Code  
M = Date Code

#### ORDERING INFORMATION

See detailed ordering, marking, and shipping information in the package dimensions section on page 2 of this data sheet.

## DTC114EET1 Series

### ORDERING INFORMATION, DEVICE MARKING and RESISTOR VALUES

| Device      | Marking | R1 (K) | R2 (K) | Package                    | Shipping†        |
|-------------|---------|--------|--------|----------------------------|------------------|
| DTC114EET1  | 8A      | 10     | 10     | SC-75/SOT-416              | 3000 Tape & Reel |
| DTC114EET1G | 8A      | 10     | 10     | SC-75/SOT-416<br>(Pb-Free) |                  |
| DTC124EET1  | 8B      | 22     | 22     | SC-75/SOT-416              |                  |
| DTC124EET1G | 8B      | 22     | 22     | SC-75/SOT-416<br>(Pb-Free) |                  |
| DTC144EET1  | 8C      | 47     | 47     | SC-75/SOT-416              |                  |
| DTC144EET1G | 8C      | 47     | 47     | SC-75/SOT-416<br>(Pb-Free) |                  |
| DTC114YET1  | 8D      | 10     | 47     | SC-75/SOT-416              |                  |
| DTC114YET1G | 8D      | 10     | 47     | SC-75/SOT-416<br>(Pb-Free) |                  |
| DTC114TET1  | 94      | 10     | ∞      | SC-75/SOT-416              |                  |
| DTC114TET1G | 94      | 10     | ∞      | SC-75/SOT-416<br>(Pb-Free) |                  |
| DTC143TET1  | 8F      | 4.7    | ∞      | SC-75/SOT-416              |                  |
| DTC143TET1G | 8F      | 4.7    | ∞      | SC-75/SOT-416<br>(Pb-Free) |                  |
| DTC123EET1  | 8H      | 2.2    | 2.2    | SC-75/SOT-416              |                  |
| DTC123EET1G | 8H      | 2.2    | 2.2    | SC-75/SOT-416<br>(Pb-Free) |                  |
| DTC143EET1  | 8J      | 4.7    | 4.7    | SC-75/SOT-416              |                  |
| DTC143EET1G | 8J      | 4.7    | 4.7    | SC-75/SOT-416<br>(Pb-Free) |                  |
| DTC143ZET1  | 8K      | 4.7    | 47     | SC-75/SOT-416              |                  |
| DTC143ZET1G | 8K      | 4.7    | 47     | SC-75/SOT-416<br>(Pb-Free) |                  |
| DTC124XET1  | 8L      | 22     | 47     | SC-75/SOT-416              |                  |
| DTC124XET1G | 8L      | 22     | 47     | SC-75/SOT-416<br>(Pb-Free) |                  |
| DTC123JET1  | 8M      | 2.2    | 47     | SC-75/SOT-416              |                  |
| DTC123JET1G | 8M      | 2.2    | 47     | SC-75/SOT-416<br>(Pb-Free) |                  |
| DTC115EET1  | 8N      | 100    | 100    | SC-75/SOT-416              |                  |
| DTC115EET1G | 8N      | 100    | 100    | SC-75/SOT-416<br>(Pb-Free) |                  |
| DTC144WET1  | 8P      | 47     | 22     | SC-75/SOT-416              |                  |

†For information on tape and reel specifications, including part orientation and tape sizes, please refer to our Tape and Reel Packaging Specifications Brochure, BRD8011/D.

# DTC114EET1 Series

## ELECTRICAL CHARACTERISTICS ( $T_A = 25^\circ\text{C}$ unless otherwise noted)

| Characteristic  | Symbol        | Min | Typ | Max  | Unit |
|---|---------------|-----|-----|------|------|
| <b>OFF CHARACTERISTICS</b>  |               |     |     |      |      |
| Collector–Base Cutoff Current ( $V_{CB} = 50\text{ V}$ , $I_E = 0$ )  | $I_{CBO}$     | –   | –   | 100  | nAdc |
| Collector–Emitter Cutoff Current ( $V_{CE} = 50\text{ V}$ , $I_B = 0$ )   | $I_{CEO}$     | –   | –   | 500  | nAdc |
| Emitter–Base Cutoff Current<br>( $V_{EB} = 6.0\text{ V}$ , $I_C = 0$ )  | $I_{EBO}$     | –   | –   | 0.5  | mAdc |
|   | DTC114EET1    | –   | –   | 0.2  |      |
|   | DTC124EET1    | –   | –   | 0.1  |      |
|   | DTC144EET1    | –   | –   | 0.2  |      |
|   | DTC114YET1    | –   | –   | 0.9  |      |
|   | DTC114TET1    | –   | –   | 1.9  |      |
|   | DTC143TET1    | –   | –   | 2.3  |      |
|   | DTC123EET1    | –   | –   | 1.5  |      |
|   | DTC143EET1    | –   | –   | 0.18 |      |
|   | DTC143ZET1    | –   | –   | 0.13 |      |
|   | DTC124XET1    | –   | –   | 0.2  |      |
|   | DTC123JET1    | –   | –   | 0.05 |      |
|   | DTC115EET1    | –   | –   | 0.13 |      |
|   | DTC144WET1    | –   | –   | 0.13 |      |
| Collector–Base Breakdown Voltage ( $I_C = 10\ \mu\text{A}$ , $I_E = 0$ )  | $V_{(BR)CBO}$ | 50  | –   | –    | Vdc  |
| Collector–Emitter Breakdown Voltage (Note 3)<br>( $I_C = 2.0\text{ mA}$ , $I_B = 0$ )   | $V_{(BR)CEO}$ | 50  | –   | –    | Vdc  |
| <b>ON CHARACTERISTICS (Note 3)</b>  |               |     |     |      |      |
| DC Current Gain<br>( $V_{CE} = 10\text{ V}$ , $I_C = 5.0\text{ mA}$ )   | $h_{FE}$      | 35  | 60  | –    |      |
|   | DTC114EET1    | 60  | 100 | –    |      |
|   | DTC124EET1    | 80  | 140 | –    |      |
|   | DTC144EET1    | 80  | 140 | –    |      |
|   | DTC114YET1    | 160 | 350 | –    |      |
|   | DTC114TET1    | 160 | 350 | –    |      |
|   | DTC143TET1    | 8.0 | 15  | –    |      |
|   | DTC123EET1    | 15  | 30  | –    |      |
|   | DTC143EET1    | 80  | 200 | –    |      |
|   | DTC143ZET1    | 80  | 150 | –    |      |
|   | DTC124XET1    | 80  | 140 | –    |      |
|   | DTC123JET1    | 80  | 150 | –    |      |
|   | DTC115EET1    | 80  | 140 | –    |      |
|   | DTC144WET1    | 80  | 140 | –    |      |
| Collector–Emitter Saturation Voltage ( $I_C = 10\text{ mA}$ , $I_B = 0.3\text{ mA}$ )<br>( $I_C = 10\text{ mA}$ , $I_B = 5\text{ mA}$ ) DTC123EET1<br>( $I_C = 10\text{ mA}$ , $I_B = 1\text{ mA}$ ) DTC143TET1/DTC114TET1/<br>DTC143EET1/DTC143ZET1/DTC124XET1 | $V_{CE(sat)}$ | –   | –   | 0.25 | Vdc  |
| Output Voltage (on)<br>( $V_{CC} = 5.0\text{ V}$ , $V_B = 2.5\text{ V}$ , $R_L = 1.0\text{ k}\Omega$ )  | $V_{OL}$      | –   | –   | 0.2  | Vdc  |
|   | DTC114EET1    | –   | –   | 0.2  |      |
|   | DTC124EET1    | –   | –   | 0.2  |      |
|   | DTC114YET1    | –   | –   | 0.2  |      |
|   | DTC114TET1    | –   | –   | 0.2  |      |
|   | DTC143TET1    | –   | –   | 0.2  |      |
|   | DTC123EET1    | –   | –   | 0.2  |      |
|   | DTC143EET1    | –   | –   | 0.2  |      |
|   | DTC143ZET1    | –   | –   | 0.2  |      |
|   | DTC124XET1    | –   | –   | 0.2  |      |
|   | DTC123JET1    | –   | –   | 0.2  |      |
| ( $V_{CC} = 5.0\text{ V}$ , $V_B = 3.5\text{ V}$ , $R_L = 1.0\text{ k}\Omega$ )   | DTC144EET1    | –   | –   | 0.2  |      |
| ( $V_{CC} = 5.0\text{ V}$ , $V_B = 5.5\text{ V}$ , $R_L = 1.0\text{ k}\Omega$ )   | DTC115EET1    | –   | –   | 0.2  |      |
| ( $V_{CC} = 5.0\text{ V}$ , $V_B = 4.0\text{ V}$ , $R_L = 1.0\text{ k}\Omega$ )   | DTC144WET1    | –   | –   | 0.2  |      |
| Output Voltage (off) ( $V_{CC} = 5.0\text{ V}$ , $V_B = 0.5\text{ V}$ , $R_L = 1.0\text{ k}\Omega$ )<br>( $V_{CC} = 5.0\text{ V}$ , $V_B = 0.25\text{ V}$ , $R_L = 1.0\text{ k}\Omega$ )  | $V_{OH}$      | 4.9 | –   | –    | Vdc  |
|   | DTC143TET1    |     |     |      |      |
|   | DTC143ZET1    |     |     |      |      |
|   | DTC114TET1    |     |     |      |      |

3. Pulse Test: Pulse Width < 300  $\mu\text{s}$ , Duty Cycle < 2.0%

# DTC114EET1 Series

## ELECTRICAL CHARACTERISTICS ( $T_A = 25^\circ\text{C}$ unless otherwise noted) (Continued)

| Characteristic |   | Symbol    | Min   | Typ   | Max   | Unit       |
|----------------|---|-----------|-------|-------|-------|------------|
| Input Resistor | TC114EET1                                       | R1        | 7.0   | 10    | 13    | k $\Omega$ |
|                | DTC124EET1                                      |           | 15.4  | 22    | 28.6  |            |
|                | DTC144EET1                                      |           | 32.9  | 47    | 61.1  |            |
|                | DTC114YET1                                      |           | 7.0   | 10    | 13    |            |
|                | DTC114TET1                                      |           | 7.0   | 10    | 13    |            |
|                | DTC143TET1                                      |           | 3.3   | 4.7   | 6.1   |            |
|                | DTC123EET1                                      |           | 1.5   | 2.2   | 2.9   |            |
|                | DTC143EET1                                      |           | 3.3   | 4.7   | 6.1   |            |
|                | DTC143ZET1                                      |           | 3.3   | 4.7   | 6.1   |            |
|                | DTC124XET1                                      |           | 15.4  | 22    | 28.6  |            |
|                | DTC123JET1                                      |           | 1.54  | 2.2   | 2.86  |            |
|                | DTC115EET1                                      |           | 70    | 100   | 130   |            |
|                | DTC144WET1                                      |           | 32.9  | 47    | 61.1  |            |
| Resistor Ratio | DTC114EET1/DTC124EET1/DTC144EET1/<br>DTC115EET1 | $R_1/R_2$ | 0.8   | 1.0   | 1.2   |            |
|                | DTC114YET1                                      |           | 0.17  | 0.21  | 0.25  |            |
|                | DTC143TET1/DTC114TET1                           |           | –     | –     | –     |            |
|                | DTC123EET1/DTC143EET1                           |           | 0.8   | 1.0   | 1.2   |            |
|                | DTC143ZET1                                      |           | 0.055 | 0.1   | 0.185 |            |
|                | DTC124XET1                                      |           | 0.38  | 0.47  | 0.56  |            |
|                | DTC123JET1                                      |           | 0.038 | 0.047 | 0.056 |            |
|                | DTC144WET1D                                     |           | 1.7   | 2.1   | 2.6   |            |

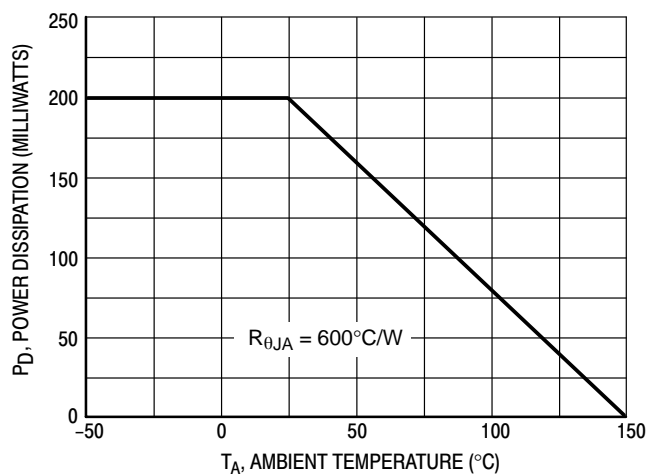

Figure 1. Derating Curve

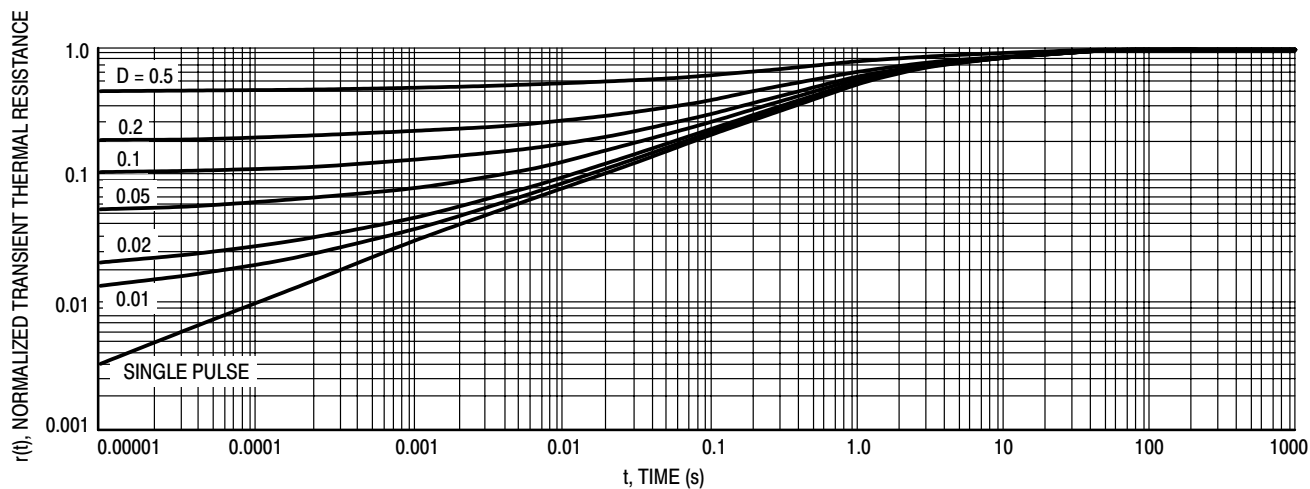

Figure 2. Normalized Thermal Response

# DTC114EET1 Series

## TYPICAL ELECTRICAL CHARACTERISTICS – DTC114EET1

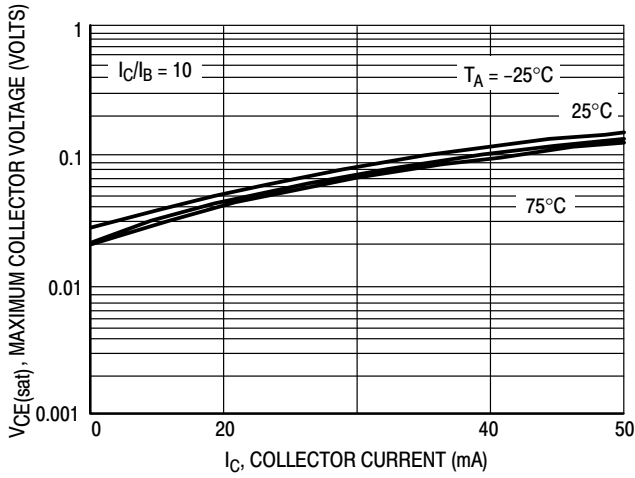

Figure 3.  $V_{CE(sat)}$  versus  $I_C$

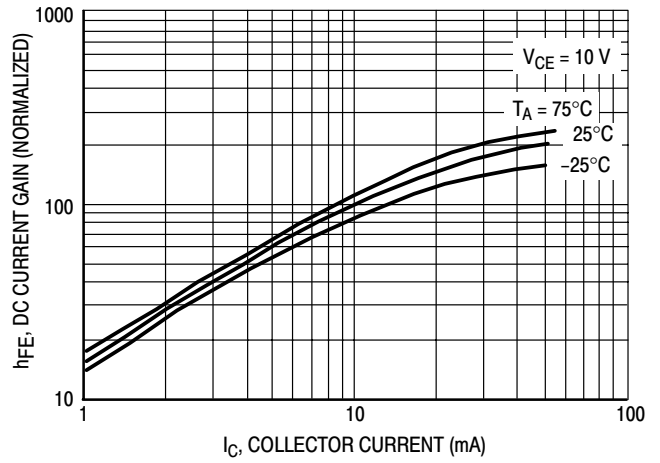

Figure 4. DC Current Gain

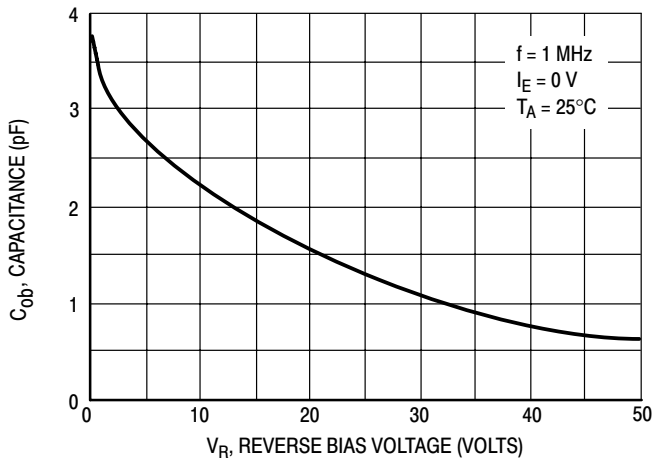

Figure 5. Output Capacitance

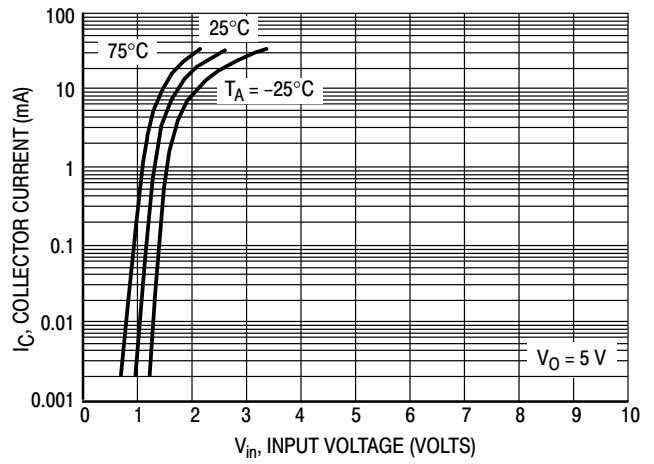

Figure 6. Output Current versus Input Voltage

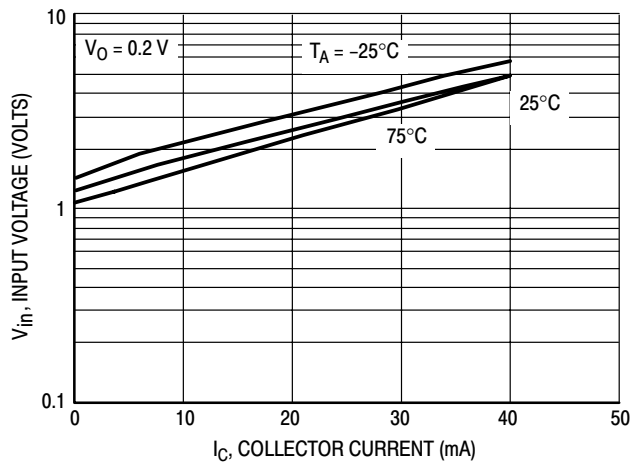

Figure 7. Input Voltage versus Output Current

# DTC114EET1 Series

## TYPICAL ELECTRICAL CHARACTERISTICS – DTC124EET1

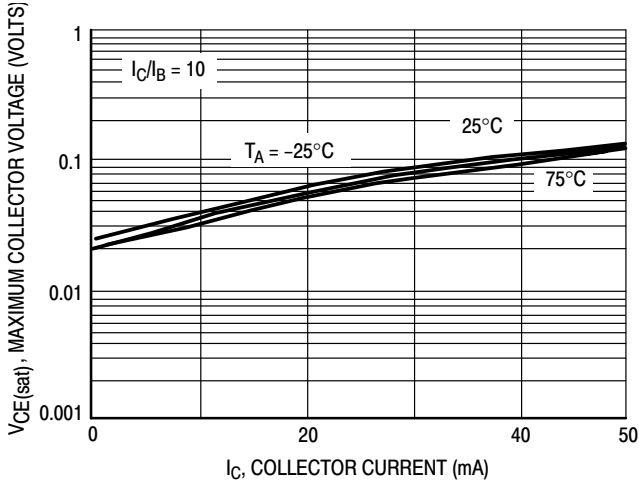

Figure 8.  $V_{CE(sat)}$  versus  $I_C$

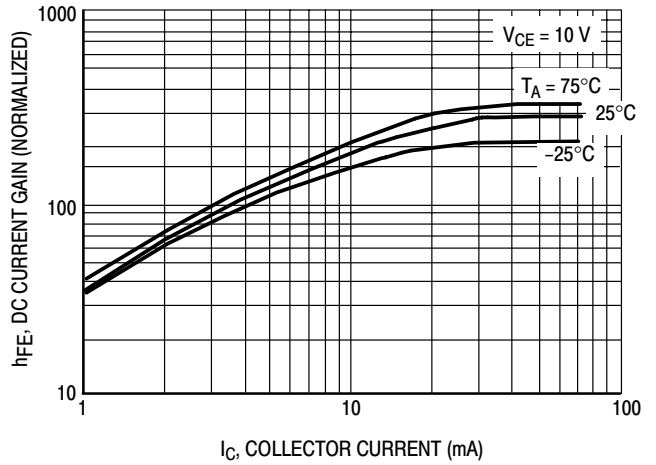

Figure 9. DC Current Gain

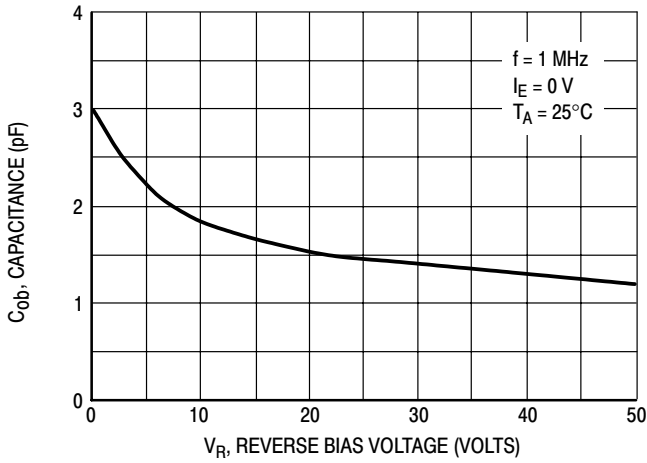

Figure 10. Output Capacitance

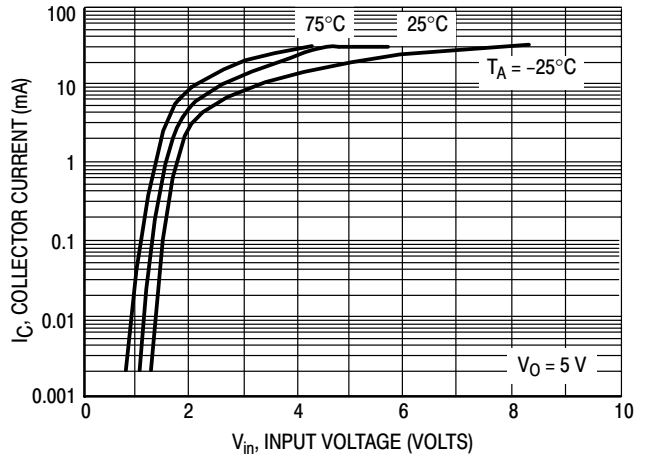

Figure 11. Output Current versus Input Voltage

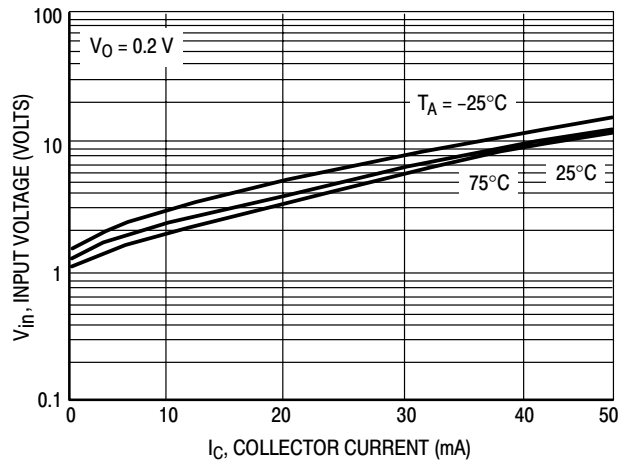

Figure 12. Input Voltage versus Output Current

# DTC114EET1 Series

## TYPICAL ELECTRICAL CHARACTERISTICS – DTC114EET1

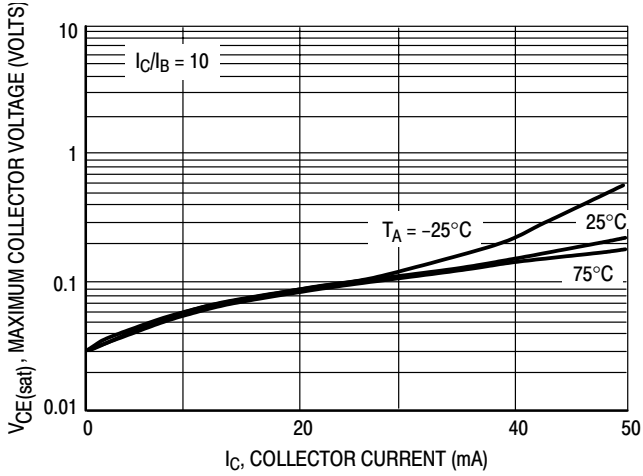

Figure 13.  $V_{CE(sat)}$  versus  $I_C$

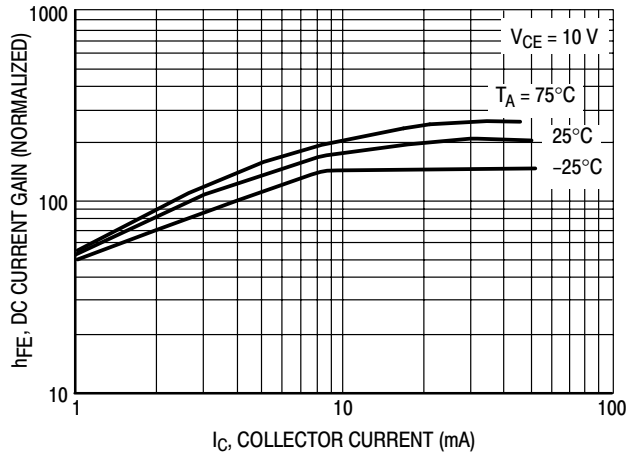

Figure 14. DC Current Gain

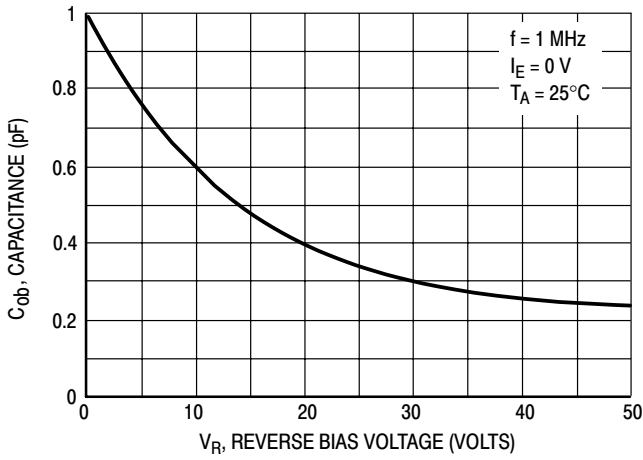

Figure 15. Output Capacitance

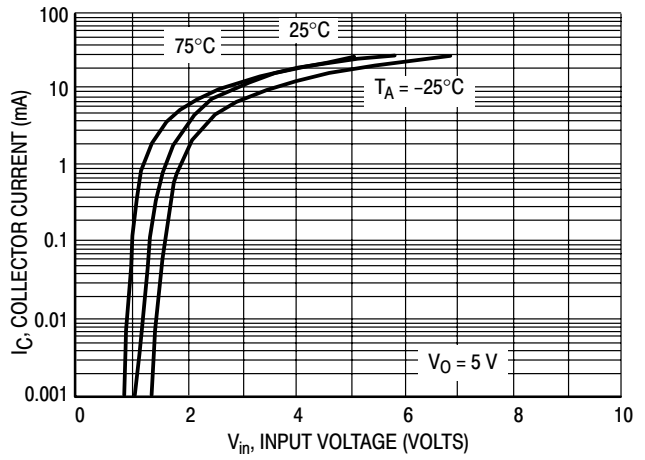

Figure 16. Output Current versus Input Voltage

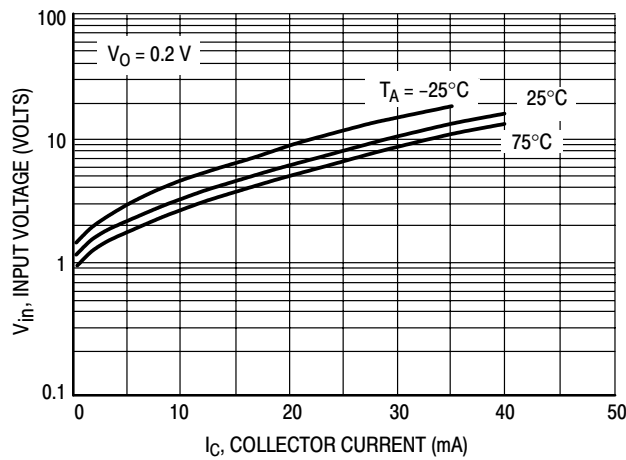

Figure 17. Input Voltage versus Output Current

# DTC114EET1 Series

## TYPICAL ELECTRICAL CHARACTERISTICS – DTC114YET1

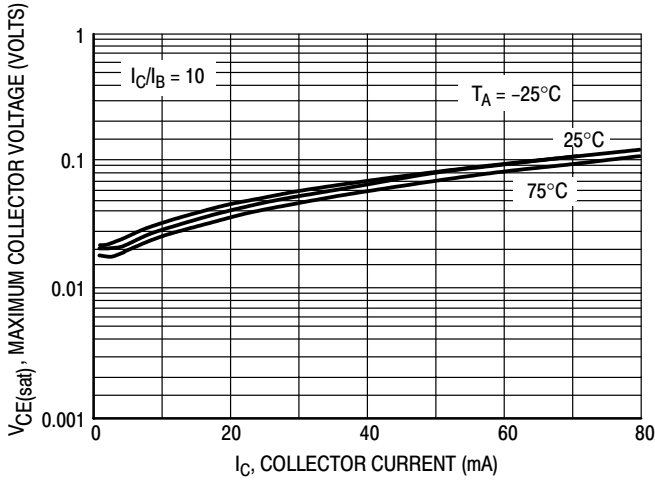

Figure 18.  $V_{CE(sat)}$  versus  $I_C$

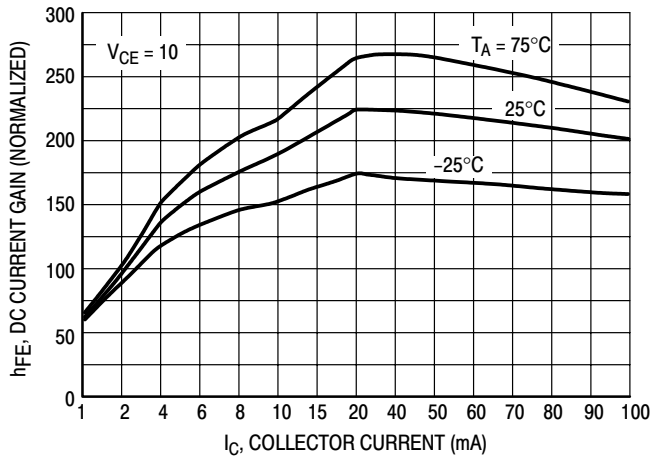

Figure 19. DC Current Gain

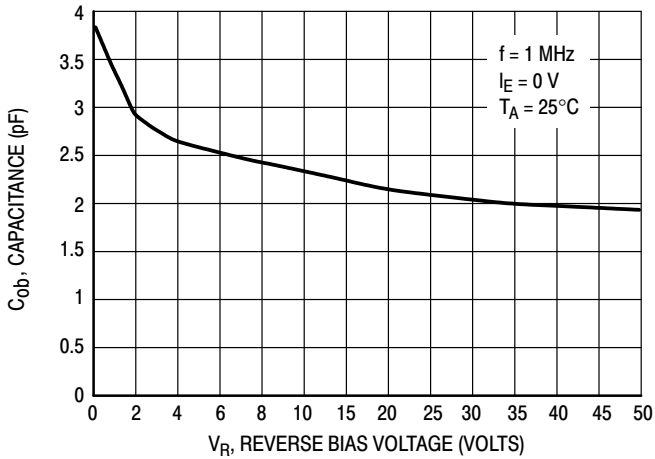

Figure 20. Output Capacitance

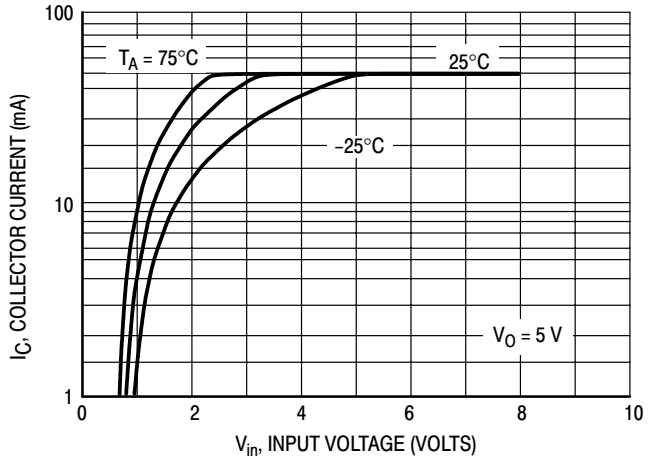

Figure 21. Output Current versus Input Voltage

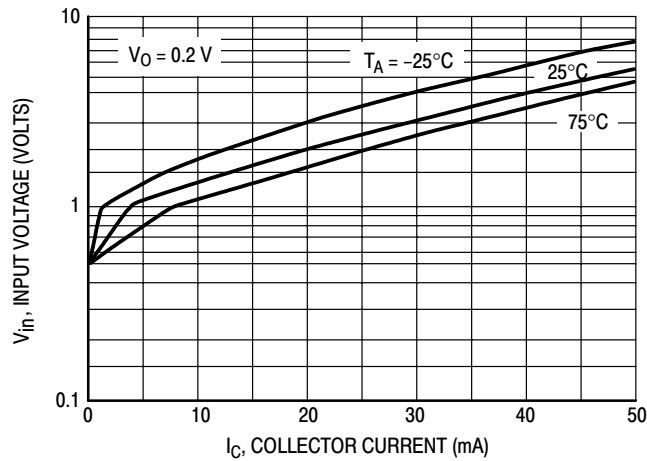

Figure 22. Input Voltage versus Output Current



# DTC114EET1 Series

## TYPICAL APPLICATIONS FOR NPN BRTs

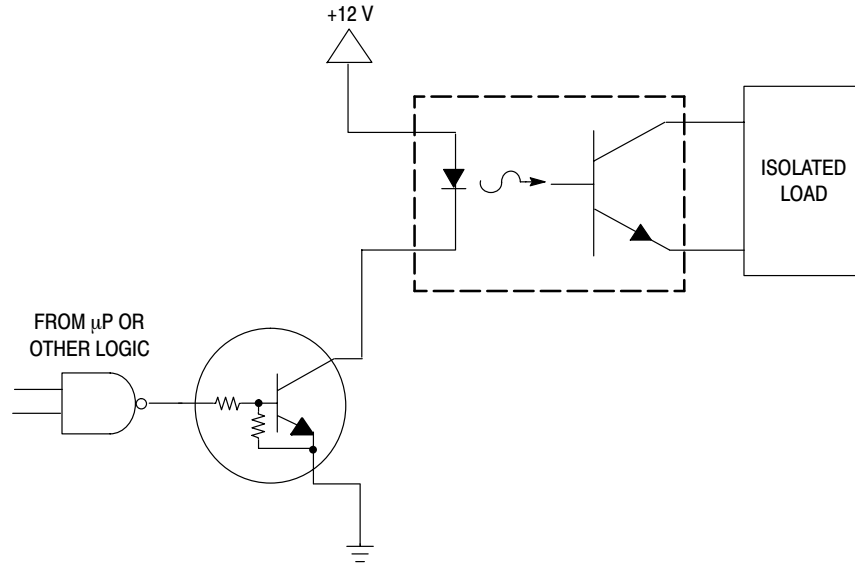

Figure 23. Level Shifter: Connects 12 or 24 Volt Circuits to Logic

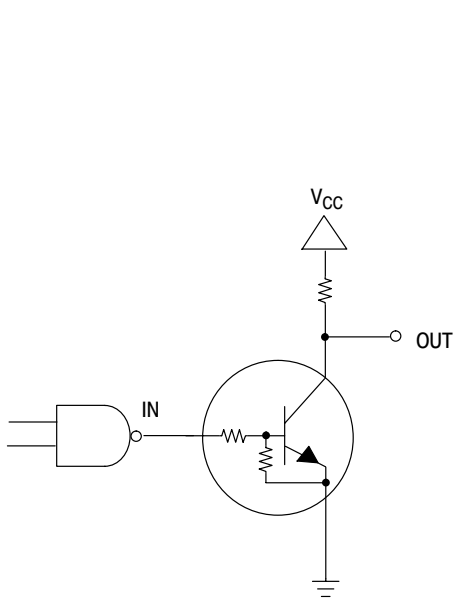

Figure 24. Open Collector Inverter:  
Inverts the Input Signal

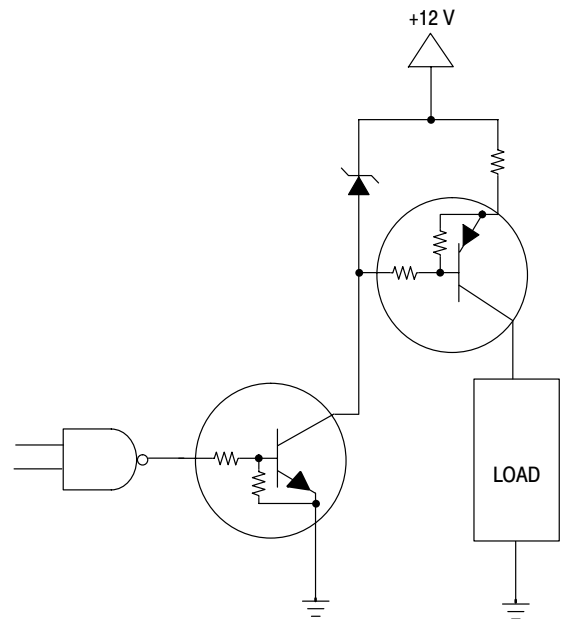
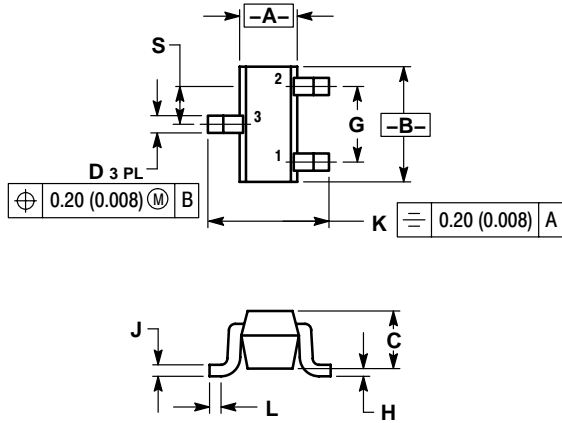

Figure 25. Inexpensive, Unregulated Current Source

# DTC114EET1 Series

## PACKAGE DIMENSIONS

SC-75/SOT-416  
CASE 463-01  
ISSUE C



### NOTES:

1. DIMENSIONING AND TOLERANCING PER ANSI Y14.5M, 1982.
2. CONTROLLING DIMENSION: MILLIMETER.

| DIM | MILLIMETERS |      | INCHES    |       |
|-----|-------------|------|-----------|-------|
|     | MIN         | MAX  | MIN       | MAX   |
| A   | 0.70        | 0.90 | 0.028     | 0.035 |
| B   | 1.40        | 1.80 | 0.055     | 0.071 |
| C   | 0.60        | 0.90 | 0.024     | 0.035 |
| D   | 0.15        | 0.30 | 0.006     | 0.012 |
| G   | 1.00 BSC    |      | 0.039 BSC |       |
| H   | ---         | 0.10 | ---       | 0.004 |
| J   | 0.10        | 0.25 | 0.004     | 0.010 |
| K   | 1.45        | 1.75 | 0.057     | 0.069 |
| L   | 0.10        | 0.20 | 0.004     | 0.008 |
| S   | 0.50 BSC    |      | 0.020 BSC |       |

### STYLE 1:

- PIN 1. BASE
- EMITTER
- COLLECTOR

## SOLDERING FOOTPRINT\*

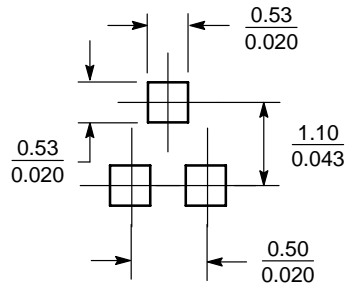

SCALE 10:1 ( $\frac{\text{mm}}{\text{inches}}$ )

\*For additional information on our Pb-Free strategy and soldering details, please download the ON Semiconductor Soldering and Mounting Techniques Reference Manual, SOLDERRM/D.

ON Semiconductor and  are registered trademarks of Semiconductor Components Industries, LLC (SCILLC). SCILLC reserves the right to make changes without further notice to any products herein. SCILLC makes no warranty, representation or guarantee regarding the suitability of its products for any particular purpose, nor does SCILLC assume any liability arising out of the application or use of any product or circuit, and specifically disclaims any and all liability, including without limitation special, consequential or incidental damages. "Typical" parameters which may be provided in SCILLC data sheets and/or specifications can and do vary in different applications and actual performance may vary over time. All operating parameters, including "Typicals" must be validated for each customer application by customer's technical experts. SCILLC does not convey any license under its patent rights nor the rights of others. SCILLC products are not designed, intended, or authorized for use as components in systems intended for surgical implant into the body, or other applications intended to support or sustain life, or for any other application in which the failure of the SCILLC product could create a situation where personal injury or death may occur. Should Buyer purchase or use SCILLC products for any such unintended or unauthorized application, Buyer shall indemnify and hold SCILLC and its officers, employees, subsidiaries, affiliates, and distributors harmless against all claims, costs, damages, and expenses, and reasonable attorney fees arising out of, directly or indirectly, any claim of personal injury or death associated with such unintended or unauthorized use, even if such claim alleges that SCILLC was negligent regarding the design or manufacture of the part. SCILLC is an Equal Opportunity/Affirmative Action Employer. This literature is subject to all applicable copyright laws and is not for resale in any manner.

## PUBLICATION ORDERING INFORMATION

### LITERATURE FULFILLMENT:

Literature Distribution Center for ON Semiconductor  
P.O. Box 61312, Phoenix, Arizona 85082-1312 USA  
Phone: 480-829-7710 or 800-344-3860 Toll Free USA/Canada  
Fax: 480-829-7709 or 800-344-3867 Toll Free USA/Canada  
Email: orderlit@onsemi.com

N. American Technical Support: 800-282-9855 Toll Free  
USA/Canada

Japan: ON Semiconductor, Japan Customer Focus Center  
2-9-1 Kamimeguro, Meguro-ku, Tokyo, Japan 153-0051  
Phone: 81-3-5773-3850

ON Semiconductor Website: <http://onsemi.com>

Order Literature: <http://www.onsemi.com/litorder>

For additional information, please contact your local Sales Representative.