

SANYO

No. 3673

LC7232-8291

1-Chip PLL + Controller

Preliminary**OVERVIEW**

The LC7232-8291 is a single-chip microcontroller that is best suited for car electronics tuning applications. It includes the internal PLL (Phase Locked Loop) circuitry that can be used all over the world, LCD driver circuitry, remote control function and anti-theft (or thief proof) function.

FEATURES

- 1) On-chipped infrared remote control receiver circuit : Transmitter IC = LC7461M (remote non-wired control and wired control)
- 2) On-chipped ANTI-THEFT function
- 3) Preset Memory function : 36 channels (Max.) = (FM1 + FM2 + FM3 + VF + MW (MW1) + LM (MW2)) x 6 (with the last channel storage)
- 4) Auto Preset Memory function : Based on the intensities of electric fields
- 5) Radio monitor function
- 6) CD function (Keys, IN and OUT)
- 7) Tape function : DIRECTION display on/off by the FF and REW input signals
- 8) Abundant tape DOUBLE FUNCTION KEY selections : Independent 2 keys added
- 9) On-chipped DKcount function
- 10) Preset Memory write modes : 2
- 11) Tape character display function
- 12) Power Key
- 13) Diode matrix selections : 30
- 14) World-wide version

Package Dimensions 3044B
(unit: mm)

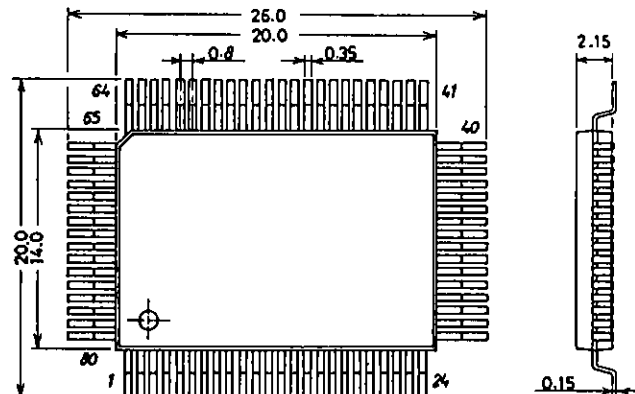

SANYO : QIP80A

SANYO Electric Co., Ltd. Semiconductor Business Headquarters
TOKYO OFFICE Tokyo Bldg., 1-10, 1 Chome, Ueno, Taito-ku, TOKYO, 110 JAPAN

PINOUT

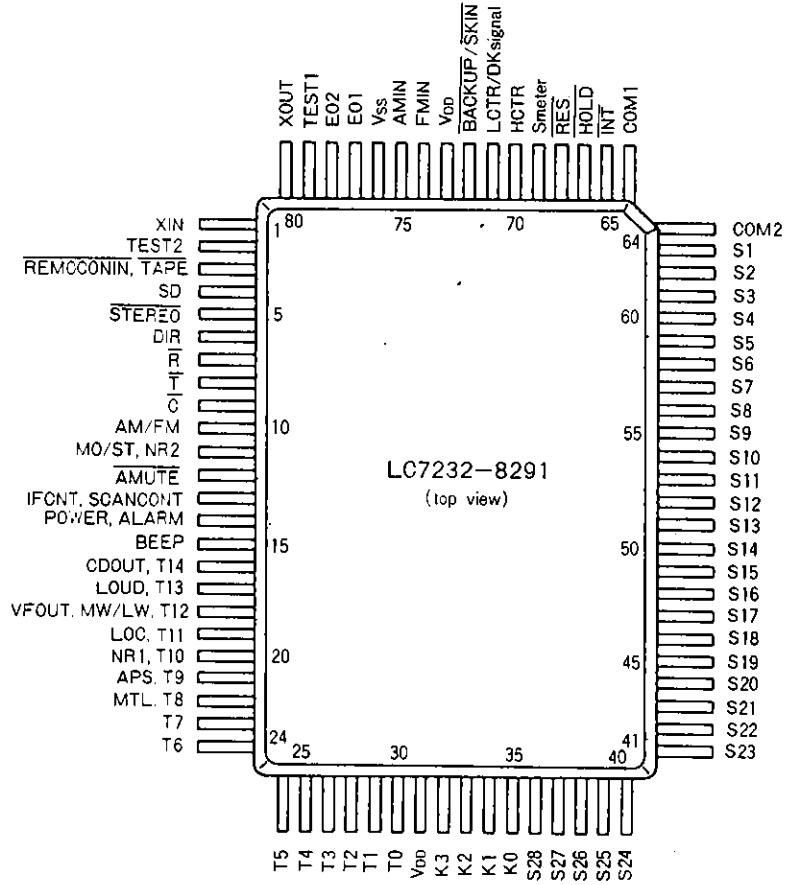

Frequencies

Area	Band	Frequency range (FM : MHz AM : kHz)	Fref. (kHz)	STEP (kHz)	IF FM(MHz) AM(kHz)	IF count tolerance (kHz)	Diode matrix (1 : on 0 : off)					
							B2	B1	B0	LW2	LW1	SHIFT
U.S.A	FM a	87.5-107.9	50	200	10.7	±10						
	MW a	530-1720	10	10	450	±3	0	0	0	0	0	0
	FM a	87.5-107.9	50	200	10.7	±10						
	MW b	530-1620	10	10	450	±3	0	0	0	0	0	1
	FM a	87.5-107.9	50	200	10.7	±10						
	MW c	531-1620	9	9	450	±3	0	0	0	0	1	0
	FM a	87.5-107.9	50	200	10.7	±10						
	MW d	531-1719	9	9	450	±3	0	0	0	0	1	1
EUROPE	FM b	87.5-108.0	50	100	10.7	±10						
	MW a	530-1720	10	10	450	±3	0	0	0	1	0	0
	FM b	87.5-108.0	50	100	10.7	±10						
	MW b	530-1620	10	10	450	±3	0	0	0	1	0	1
	FM b	87.5-108.0	50	100	10.7	±10						
	MW c	531-1620	9	9	450	±3	0	0	0	1	1	0
	FM b	87.5-108.0	50	100	10.7	±10						
	MW d	531-1719	9	9	450	±3	0	0	0	1	1	1
EUROPE	FM c	87.5-108.0	25	50	10.7	±10						
	MW e	522-1620	9	9	450/459	±3	0	0	1	0	0	0/1
	LW a	153-281	1	1(9)	↑	±0.6				0	1	
	FM c	87.5-108.0	25	50	10.7	±10						
	MW c	531-1620	9	9	450/459	±3	0	1	0	0	0	0/1
	LW a	153-281	1	1(9)	↑	±0.6				0	1	
	FM d	87.5-108.0	12.5	25	10.7	±10						
	MW e	522-1620	9	9	450/459	±3	0	1	1	0	0	0/1
	LW a	153-281	1	1(9)	↑	±0.6				0	1	
	FM d	87.5-108.0	12.5	25	10.7	±10						
	MW c	531-1620	9	9	450/459	±3	1	0	0	0	0	0/1
	LW a	153-281	1	1(9)	↑	±0.6				0	1	
EUROPE	FM c	87.5-108.0	25	50	10.7	±10						
	MW e	522-1620	9	9	450/459	±3	0	0	1	0	0	0/1
	LW b	146-290	1	1(9)	↑	±0.6				1	0	
	FM c	87.5-108.0	25	50	10.7	±10						
EUROPE	MW c	531-1620	9	9	450/459	±3	0	1	0	0	0	0/1
	LW b	146-290	1	1(9)	↑	±0.6				1	0	
	FM d	87.5-108.0	12.5	25	10.7	±10						
	MW e	522-1620	9	9	450/459	±3	0	1	1	0	0	0/1
EUROPE	LW b	146-290	1	1(9)	↑	±0.6				1	0	
	FM d	87.5-108.0	12.5	25	10.7	±10						
	MW c	531-1620	9	9	450/459	±3	1	0	0	0	0	0/1
	LW b	146-290	1	1(9)	↑	±0.6				1	0	
JAPAN	FM e	76.0-90.0	50	100	-10.7	±10						
	MW f	522-1629	9	9	450	±3	1	0	1	0	0	0
SAUDI-ALABIA	FM b	87.5-108.0	50	100	-10.7	±10						
	MW g	531-1602	9	9	450	±3	1	0	1	0	0	1
SOUTH-AFRICA	FM f	87.5-108.0	50	100	-10.7	±10						
	MW g	531-1602	9	9	450	±3	1	0	1	0	1	0
EAST-EUROPE	FM g	64.0-108.0	25	50	10.7	±10						
	MW h	522-1620	9	9	450	±3	1	0	1	1	0	0

Notes:

1. In the Europe area, the diode matrix 'SHIFT' is used to select the desired IF frequency.
2. The (9)s of the STEP are the STEP values that will be effective with the IFcount inactive in the Auto Tuning mode.

Major Specifications

Absolute Maximum Ratings/Ta = 25°C, Vss = 0V

Parameter	Symbol	Conditions	Rating	Unit
Supply Voltage	VDD max		-0.3to+6.5	V
Input Voltage	VIN(1)	HOLD, INT, RES, Smeter, BACKUP	-0.3to+13	V
	VIN(2)	Input other than VIN(1)	-0.3toVDD+0.3	V
Output Voltage	VOUT(1)	R, T, C, AM/FM	-0.3to+15	V
	VOUT(2)	Output other than VOUT(1)	-0.3toVDD+0.3	V
Output Current	IOUT(1)	R, T, C, AM/FM, T8toT11	0to5	mA
	IOUT(2)	T12to14, BEEP, POWER, IFCNT, MO/ST S1toS28	0to3	mA
	IOUT(3)	T0toT7	0to1	mA
Allowable Power Dissipation	Pd max	Ta=-40to+85°C	400	mW
Ambient Operating Temperature Range	Topr		-40to+85	°C
Ambient Storage temperature Range	Tstg		-40to+125	°C

Recommended Operating Conditions/Ta = -40°C to +85°C, VDD = 3.5V to 5.5V

Parameter	Symbol	Conditions	Standard values			Unit
			Min	Typ	Max	
Supply Voltage	VDD(1)	CPU, PLL operation	4.5		5.5	V
	VDD(2)	CPU operation	3.5		5.5	V
	VDD(3)	Memory hold	1.3		5.5	V
High-level Input Voltage	VIH(1)	REMOCONIN, SD, STEREO, DIR	0.7VDD		8.0	V
	VIH(2)	RES, INT, HOLD	0.8VDD		8.0	V
	VIH(3)	BACKUP	2.5		8.0	V
	VIH(4)	K0toK3	0.6VDD		VDD	V
	VIH(5)	T12toT14, BEEP, POWER, IFCNT AMUTE, MO/ST	0.7VDD		VDD	V
	VIH(6)	LCTR	0.8VDD		VDD	V
Low-level Input Voltage	VIL(1)	REMOCONIN, SD, STEREO, DIR	0		0.3VDD	V
	VIL(2)	RES, INT	0		0.2VDD	V
	VIL(3)	BACKUP	0		1.3	V
	VIL(4)	K0toK3	0		0.2VDD	V
	VIL(5)	T12toT14, BEEP, POWER, IFCNT AMUTE, MO/ST	0		0.3VDD	V
	VIL(6)	LCTR	0		0.2VDD	V
	VIL(7)	HOLD	0		0.4VDD	V
Input Frequency	fIN(1)	XIN VIN(1) VDD(1)	4.0	4.5	5.0	MHz
	fIN(2)	FMIN VIN(2) VDD(1)	10		130	MHz
	fIN(3)	AMIN(MW, LW) VIN(3) VDD(1)	0.5		10	MHz
	fIN(4)	HCTR(FMIF, AMIF) VIN(4) VDD(1)	0.4		12	MHz
	fIN(5)	LCTR AMIF : VIN(3) VDD(1) DKsig : VIH(6) VIL(6) VDD(1)	1		500K	Hz
Input Amplitude	VIN(1)	XIN	0.50		1.5	Vrms
	VIN(2)	FMIN	0.10		1.5	Vrms
	VIN(3)	AMIN	0.15		1.5	Vrms
	VIN(4)	HCTR	0.10		1.5	Vrms
Input Voltage Range	VIN(5)	Smeter	0		VDD	V

Electrical characteristics (in line with the recommended operating conditions)

Parameter	Symbol	Conditions	Standard values			Unit
			Min	Typ	Max	
Hysteresis Voltage	V _H	RES, INT	0.1V _{DD}			V
Reject Pulse Width	PREJ	BACKUP			50	μsec
Power-down Detect Voltage	V _{DET}		2.7	3.0	3.3	V
"H"-level Input Current	I _{IH} (1)	INT, HOLD, RES, Smeter, BACKUP, SD, REMOCONIN, STEREO, DIR. V _I =5.5V			3.0	μA
	I _{IH} (2)	T12toT14, BEEP, POWER, IFCNT, MO/ST, AMUTE Output-off V _I =V _{DD}			3.0	μA
	I _{IH} (3)	XIN V _I =V _{DD} =5.0V	2.0	5.0	15	μA
	I _{IH} (4)	FMIN, AMIN, HCTR, LCTR V _I =V _{DD} =5.0V	4.0	10	30	μA
	I _{IH} (4)	K0toK3 V _I =V _{DD} =5.0V		50		μA
"L"-level Input Current	I _{IL} (1)	V _I =V _{SS}			3.0	μA
	I _{IL} (2)	V _I =V _{SS}			3.0	μA
	I _{IL} (3)	V _I =V _{SS}	2.0	5.0	15	μA
	I _{IL} (4)	V _I =V _{SS}	4.0	10	30	μA
Input Floating Voltage	V _{IF}	K0toK3			0.05V _{DD}	V
Pull-down Resistor	RPD	K0toK3	75	100	200	kΩ
"H"-level Output-off Leakage Current	I _{OFFH} (1)	EO1, EO2 V _O =V _{DD}		0.01	10	nA
	I _{OFFH} (2)	T0toT14, BEEP, POWER, IFCNT, MO/ST, AMUTE, S25toS28 V _O =V _{DD}			3.0	μA
	I _{OFFH} (3)	R̄, T̄, C̄, AM/FM V _O =13V			5.0	μA
"L"-level Output-off Leakage Current	I _{OFFL} (1)	EO1, EO2 V _O =V _{SS}		0.01	10	nA
	I _{OFFL} (2)	T0toT14, BEEP, POWER, IFCNT, MO/ST, AMUTE V _O =V _{SS}			3.0	μA
"H"-Level Output Voltage	V _{OH} (1)	T0toT7 I _O =1 mA	V _{DD} -2.0	V _{DD} -1.0	V _{DD} -0.5	V
	V _{OH} (2)	T12toT14, BEEP, POWER, IFCNT, MO/ST, AMUTE, S25toS28 I _O =1 mA	V _{DD} -1.0			V
	V _{OH} (3)	EO1, EO2 I _O =500μA	V _{DD} -1.0			V
	V _{OH} (4)	XOUT I _O =200μA	V _{DD} -1.0			V
	V _{OH} (5)	S1toS28 I _O =-0.1mA	V _{DD} -1.0			V
	V _{OH} (6)	T8toT11 I _O =5 mA	V _{DD} -1.0			V
	V _{OH} (7)	COM1, COM2 I _O =20μA	V _{DD} -0.7	V _{DD} -0.5	V _{DD} -0.35	V
"L"-level Output Voltage	V _{OL} (1)	T0toT7 I _O =1 mA	0.5	1.0	2.0	V
	V _{OL} (2)	T12toT14, BEEP, POWER, IFCNT, MO/ST, AMUTE, S25toS28 I _O =1 mA			1.0	V
	V _{OL} (3)	EO1, EO2 I _O =500μA			1.0	V
	V _{OL} (4)	XOUT I _O =200μA			1.0	V
	V _{OL} (5)	S1toS28 I _O =0.1mA			1.0	V
	V _{OL} (6)	T8toT11 I _O =5 mA			1.0	V
	V _{OL} (7)	COM1, COM2 I _O =20μA			1.0	V
	V _{OL} (8)	R̄, T̄, C̄, AM/FM I _O =5 mA	0.75 (150Ω)		2.0 (400Ω)	V

Continued on the next page.

Continued from the preceding page.

Parameter	Symbol	Conditions	Standard values			Unit
			Min	Typ	Max	
Output Intermediate-level Voltage	V_M	COM1, COM2 $V_{DD} = 5V, I_o = 20\mu A$	2.0	2.5	3.0	V
AD Conversion Error	E_{VV}	Smeter $V_{DD}(1)$	-1/2		+1/2	LSB
Supply Current	$I_{DD}(1)$	$V_{DD}(1), f_{IN} = 130MHz$		15	20	mA
	$I_{DD}(2)$	$V_{DD}(2)$ PLL stop (in the HOLD mode. See Fig. 1.)		0.7		mA
	$I_{DD}(3)$	$V_{DD} = 5.5V$. OSC stop. $T_a = 25^\circ C$. (in the BACK UP mode. See Fig. 2.)			5	μA
		$V_{DD} = 2.5V$. OSC stop. $T_a = 25^\circ C$. (in the BACK UP mode. See Fig. 2.)			1	μA

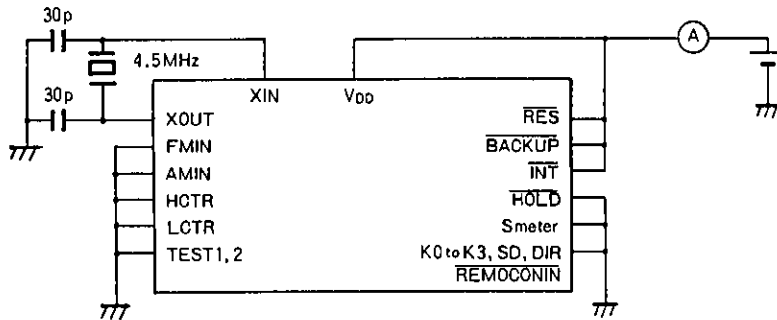

Note: T0 to T4, BEEP, POWER, IFCNT, \overline{AMUTE} , MO/ST, AM/FM, \overline{R} , \overline{T} , \overline{C} , S1 to S28, COM1 and COM2 = 'Open'

Fig. 1 $I_{DD}(2)$ measurement circuit in the HOLD mode

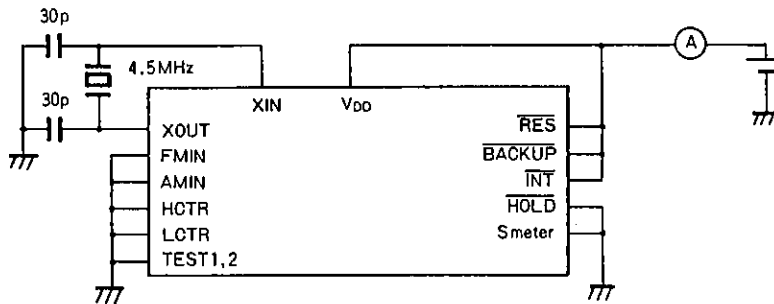

Note: T0 to T4, BEEP, POWER, IFCNT, \overline{AMUTE} , MO/ST, AM/FM, \overline{R} , \overline{T} , \overline{C} , S1 to S28, COM1 and COM2 = 'Open'

Fig. 2 $I_{DD}(3)$ measurement circuit in the BACK UP mode

Unit (capacitance: F)

Key and Diode Matrix

IN OUT	K0	K1	K2	K3
T0	LOUD	M1	M2	M3
T1	MO/ST	M4 APS	M5 NR	M6 MTL
T2	VF	DOWN	UP	SCAN UP
T3	BAND	SEEK DOWN	SEEK UP	CD
T4	LOC	HA APS	MA NR	PS AMEM
T5	DISPLAY *△	RMON	POWER	ME △
T6	TAPE ■	CDIN ■	FF ■	REW ■
T7	CLOCK ▲	CD SELECT ▲	SKIN ■	DKIN ■
T8 (MTL)	B0 ▲	B1 ▲	B2 ▲	IFSHIFT ▲
T9 (APS)	FMB0 ▲	FMB1 ▲	LW1 ▲	LW2 ▲
T10 (NR1)	NR C ▲	MEMORY TYPE ▲	POWER SW ▲	PRIORITY ▲
T11 (LOC/NR2)	IF COUNT0 ▲	IF COUNT1 ▲	COLON ▲	VF AUTORETUNE ▲
T12 (VFOUT)	DOUBLE FUNCTION 0 ▲	DOUBLE FUNCTION 1 ▲	DOUBLE FUNCTION 2 ▲	VF SELECT ▲
T13 (LOUD)	REMOCON ▲	DK COUNT ▲	ANTI THEFT ▲	POWER OFF CLOCK ON ▲
T14 (CDOUT)	TAPE IND ▲	FKEY0 ▲	FKEY1 ▲	DIR DISPLAY ▲

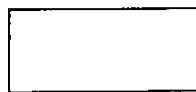

=

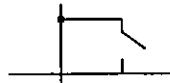

Momentary switch

*The [DISPLAY] will be used as the momentary switch if the [ME] is used.

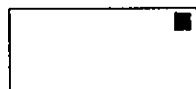

=

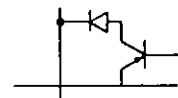

Transistor matrix



=

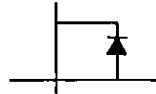

Diode matrix

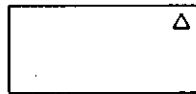

=

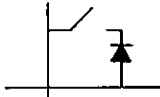

Diode & momentary switch

* The **DISPLAY** will be used as the diode and momentary switch if the **ME** is not used.

Pin Description

Pin No.	Name	I/O	Assignment	Active logic	Functional description	Unused pin handling
1	XIN	I	—	—	Connected with 4.5kHz X'tal(Crystal) oscillator	—
2	TEST2	I	—	—	Grounded to the common ground.	—
3	PG3	I	REMOCONIN TAPE	L	Connected to the INT pin (active low) and used for the LC7461M signal input. If the REMOCON is not used, this pin can be used for Tape input. The TRMRX TAPE transistor is not required.	Direct connection with the VDD
4	PG2	I	SD	H	This signal is an input signal used in the auto tuning mode to indicate that the desired channel frequency has been received.	—
5	PG1	I	STEREO	L	The RADIO mode will be activated 500ms later after the HOLD pin becomes inactive ('H'). The 'ST' will be turned on if the HOLD pin (active L) becomes active only in the FM and VF modes. The display will be activated 500ms later after the HOLD pin changes to 'H' from 'L'.	Direct connection with the VDD
6	PG0	I	DIR	H/L	This is used to indicate the 'direction' during TAPE mode. If this pin level is 'H' with the DIMRX 'TAPE IND' = 0, the 'x' will be turned on. If that level is 'L', the 'x' will be turned on.	Direct connection with the VSS or the VDD
7	PH3	O	R̄	L	Radio source select. This pin has the OD (Open Drain) type output circuit, which requires a pull-up resistor addition.	open
8	PH2	O	T̄	L	Tape source select. This pin has the OD (Open Drain) type output circuit, which requires a pull-up resistor addition.	open
9	PH1	O	C̄	L	CD source select. This pin has the OD (Open Drain) type output circuit, which requires a pull-up resistor addition.	open
10	PH0	O	AM/FM	H/L	Output signal used for selecting the FM or AM band: L-level output = FM, H-level output = AM.	open
11	PF3	O	MO/ST	H	Controls the ST display in the RADIO FM mode (including the VF and RADIO monitor). If this output is 'L', the ST display circuit is activated. If it is 'H', its display will be turned off. This output level will be 'L' if the HOLD pin (active low) becomes active (clock selected), and the AM or CD mode is activated. Controls the 'DNR' display and the 'C' (preset 'CH' digit display character) display with the DIMRX 'NR' = '1' (DNR-C selection) in the TAPE mode: 'H' output = display ON, 'L' output = display OFF. This output signal becomes effective with HOLD pin = 'H' and at the power on.	open
			NR2	H		
12	PF2	O	AMUTE	L	Audio mute control output. This pin will be 'H' if the HOLD pin becomes active (clock selected).	open
13	PF1	O	IFCNT	H	ON-OFF control signal for IFCOUNT buffer. This signal will be 'H' only when the SD signal becomes active in the Auto Search mode. In other cases, the pin level will remain Low.	open
			SCANCONT	H		
14	PF0	O	POWER	H	This output will be 'H' at the power on (when the POWER key is pressed with the DIMRX 'POWER SW' = 1).	open
			ALARM	H		
15	PE3	O	BEEP	H	This signal will become active for about 50ms if the valid key is pressed.	open
16	PE2	O	CDOUT	H	CD power source select output.	open
			T14	H		
17	PE1	O	LOUD	H	Controls the 'LOUD' display: 'H' for the 'LOUD' display ON, 'L' for the 'LOUD' display OFF. This signal will be effective only at the power on with the HOLD pin = 'H' (inactive).	open
			T13	H		

Continued on the next page.

LC7232-8291

Pin No.	Name	I/O	Assignment	Active logic	Functional description	Unused pin handling
18	PE0	O	VFOUT	H	VF control output	open
			MW/LW	L/H	MW or LW select control out MW:'L' LW:'H'	
			T12	H	diode scan out	
19	PD3	O	LOC	H	This signal will be active only when the SEEK or the SCAN operation is being carried out with the 'LOC' display ON in the RADIO mode. If the 'LOC' display is inactivated, this signal will be 'L'. Note that the output signal is effective at the power on with the HOLD = 'H'.	open
			T11	H	diode scan out	
20	PD2	O	NR1	H	This signal will be active only when the 'NR' and the preset CH digit display 'B' are turned on in the TAPE mode. If they are inactivated, this signal will be 'L'. Note that the output signal is effective only at the power on with the HOLD = 'H'.	open
			T10	H	diode scan out	
21	PD1	O	APS	H	This signal will be active only when the 'APS' is turned on in the TAPE mode. If that display is turned off, this signal will be 'L'.	open
			T9	H	diode scan out	
22	PD0	O	MTL	H	This signal will be active only when the 'MTL' is turned on in the TAPE mode. If that display is turned off, this signal will be 'L'.	open
			T8	H	diode scan out	
23	PC3	O	T7	H	diode scan out	open
24	PC2	O	T6	H	key scan out	open
25	PC1	O	T5	H	key scan out	open
26	PC0	O	T4	H	key scan out	open
27	PB3	O	T3	H	key scan out	open
28	PB2	O	T2	H	key scan out	open
29	PB1	O	T1	H	key scan out	open
30	PB0	O	T0	H	key scan out	open
31	VDD	—	—	—	+5V supply voltage input	open
32	PA3	I	K3	H	key, diode scan in	open
33	PA2	I	K2	H	key, diode scan in	open
34	PA1	I	K1	H	key, diode scan in	open
35	PA0	I	K0	H	key, diode scan in	open

LC7232-8291

Pin No.	Name	I/O	COM1	COM2	Unused pin handling
36	S28	O	ST	LOC	open
37	S27	O	DNR	MTL	open
38	S26	O	APS	LOUD	open
39	S25	O	AM	PM	open
40	S24	O	1 a	RMON	open
41	S23	O	1 d	1 c	open
42	S22	O	1 e	1 g	open
43	S21	O	1 f	1 b	open
44	S20	O	2 a	5	open
45	S19	O	2 d	2 c	open
46	S18	O	2 e	2 g	open
47	S17	O	2 f	2 b	open
48	S16	O	3 a	d p	open
49	S15	O	3 d	3 c	open
50	S14	O	3 e	3 g	open
51	S13	O	3 f	3 b	open
52	S12	O	4 a	colon	open
53	S11	O	4 d	4 c	open
54	S10	O	4 e	4 g	open
55	S9	O	4 f	4 b	open
56	S8	O	5 a	SK	open
57	S7	O	5 d	5 c	open
58	S6	O	5 e	5 g	open
59	S5	O	ST	5 b	open
60	S4	O	LW (MW2)	V F	open
61	S3	O	FM3	MW (MW1)	open
62	S2	O	FM1	FM2	open
63	S1	O	<	>	open
64	COM2	O	COMMON driver		open
65	COM1	O	COMMON driver		open

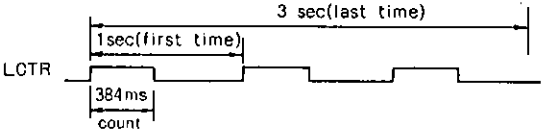
Pin No.	Name	I/O	Assignment	Active logic	Functional Description	Unused pin handling
66	INT	I	REMOCONIN	L	REMOTE CONTROL signal input. This pin requires a pull-up resistor to be externally added.	Direct connection with the VDD pin.
67	HOLD	I	HOLD	L	POWER ON/OFF detect input. This pin is preceded by the POWER SW in its closed circuit. If the pin changes from 'H' to 'L', the chip enters the following operational states: - With clock: The oscillation does not stop and the clock count continues. (HOLD mode, I _{DD} = 0.7mA (typical)) - Without clock: The oscillation stops and the power save mode will be started. (BACKUP mode, I _{DD} = 5uA (Max.))	—
68	RES	I	—	L	Direct connection to the VDD	Direct connection with the VDD pin.
69	ADI	I	S meter	—	S meter signal input: The input signal should be within the range between 0V and 3.2V. If the input signal exceeds the upper limit (3.2V), it should reach the chip pin via a resistor divider. This pin should be connected to the VDD pin if the chip stores signals sequentially (SD timings) from M1.	Direct connection with the VDD pin.
70	HCTR	I	HCTR	—	FMIF and AMIF inputs. The input signals should reach the chip pin through the AC coupling and be greater than 100mV (rms). For more information, refer to the DIMRX 'IFCOUNT0, and '1' section. tolerance : FM ±10kHz MW ± 3 kHz LW ±0.6kHz	Direct connection with the VSS pin.
71	LCTR	I	LCTR	—	AMIF input. The input signal should reach the chip pin through the AC coupling and be greater than 100mV (rms). For more information, refer to the DIMRX 'IFCOUNT0, and '1' section. tolerance : MW ± 3 kHz LW ±0.6kHz	Direct connection with the VSS pin.
			DKsignal	—	DK signal 125Hz COUNT input. The LCTR frequency measurement is started every second. If an input signal is measured for 384ms three times in a row and its frequency is within the range between 115Hz and 135Hz (125Hz ± 10Hz) at each time, the input signal will be handled as the DK input.  The DK input amplitude should be within the ranges: V _{IH} =0.8V _{DD} to V _{DD} , V _{IL} =0 to 0.2V _{DD} .	
72	SNS	I	SKIN	L	In the application without the ANTI-THEFT function, this pin is used as the SKIN (active low). If the pin level is 'L', the SK display is turned on. This input pin has the same function as the TRMRX input 'SKIN'. This pin can also be used as the BACKUP pin (active low) as discussed below.	Direct connection with the VDD pin.
			BACKUP	L	This pin is used to detect a MEMO line disconnection. The drower type and the ANTI-THEFT (or thief-proof) TYPE set products use this pin.	
73	VDD		—	—	+5 supply voltage input pin	—
74	FMIN	I	—	—	FM local OSC input. The input signal should reach the chip pin through the AC coupling and be greater than 100mV (rms).	Direct connection with the VSS pin.
75	AMIN	I	—	—	AM local OSC input. The input signal should reach the chip pin through the AC coupling and be greater than 100mV (rms).	Direct connection with the VSS pin.
76	VSS		—	—	Grounded to the common ground.	—
77	EO1	O	—	—	Phase comparator output. To be connected to the LPF (Low Pass Filter). Same as the EO2 pin.	open
78	EO2	O	—	—	Phase comparator output. To be connected to the LPF (Low Pass Filter). Same as the EO1 pin.	open
79	TEST1	I	—	—	Connected to the common ground.	—
80	XOUT	O	—	—	Connected to the 4.5MHz X'tal (crystal) oscillator.	—

Diode Matrix (DIMRX) Select

0: without diode, 1: with diode

diode matrix name	on /off	Functional Description																			
CLOCK	0	Selects the clock function: The current dissipation (IDD) will be 0.7mA in the clock operation mode with the ACC = 'OFF' (HOLD pin = 'L'). 12Hr : USA, JAPAN, SAUDI-ALABIA, SOUTH-AFRICA 24Hr : EUROPE, EAST-EUROPE																			
	1	Does not select the clock function: The current dissipation (IDD) will be 5uA (Max.) after the chip enters the BACKUP operation mode with the ACC = 'OFF' (HOLD pin = 'L').																			
CD SELECT	0	Does not select the CD function: CDIN inhibited. The CDOUT pin level will be set to 'L'.																			
	1	Selects the CD function: CDIN enabled. The CDOUT pin level will be 'H' when the CDIN changes to 'L'.																			
B0 B1 B2 IFSHIFT LW1 LW2	—	See the frequency table.																			
FMB0 FMB1	FMB1	FMB0	FM preset channels																		
	0	0	FM1, FM2, FM3 (18 channels)																		
	0	1	FM1, FM2 (12 channels)																		
	1	0	FM1 (6 channels)																		
	1	1	Not assigned																		
NR C	0	Does not select the DNR C: With the NR key, the display changes in the order of 'off' and then NR B. The 'DNR' display is also turned on.																			
	1	Selects the DNR C: With the NR key, the display changes in the order of 'off', NR B and then NR C.																			
		<table border="1"> <thead> <tr> <th>KEY on</th> <th>off</th> <th>NR B</th> <th>NR C</th> </tr> </thead> <tbody> <tr> <td>Digit 1 display data</td> <td>off</td> <td>b "DNR"</td> <td>⌈ "DNR"</td> </tr> <tr> <td rowspan="2">Pins</td> <td>NR1</td> <td>L</td> <td>H</td> </tr> <tr> <td>NR2</td> <td>L</td> <td>L</td> </tr> </tbody> </table>				KEY on	off	NR B	NR C	Digit 1 display data	off	b "DNR"	⌈ "DNR"	Pins	NR1	L	H	NR2	L	L	Display digit 1 indicates each mode.
KEY on	off	NR B	NR C																		
Digit 1 display data	off	b "DNR"	⌈ "DNR"																		
Pins	NR1	L	H																		
	NR2	L	L																		
MEMORY TYPE	0	Allows memory update without the ME key: Any of M1 to M6 keys needs to be pressed for more than 1.5 seconds. The ME key is not used.																			
	1	Allows memory update with the ME key: Any of M1 to M6 keys needs to be pressed within 5 seconds after the ME key is pressed.																			
POWER SW	0	Controls the power ON/OFF with the HOLD pin: See section 11, 'Example power source connection'.																			
	1	Controls the power ON/OFF with the POWER key: See section 11, 'Example power source connection'.																			
PRIORITY	0	Clock display is given priority.																			
	1	Frequency, TAPE and CD displays are given priority.			This applies only to the case where the clock function has been selected (DIMRX 'CLOCK' = '0').																
IFCOUNT 0 IFCOUNT 1	IFCOUNT 1	IFCOUNT 0	count mode	HCTR pin	LCTR pin	note															
	0	0	selected	FMIF	AMIF																
	1	0	Not selected	grounded	(DK signal)	LW: In the SEEK mode * with STEP = 9kHz.															
COLON	0	Turns on the colon display in the clock mode:																			
	1	Turns on and off the colon display : ON-OFF cycle = 1Hz																			
VF AUTORETUNE	0	Activates the auto retune mode: The auto retune mode will be started if the SKIN (active low) = 'H' continues 30 seconds in the VF mode. The ALARM output is still effective.																			
	1	Does not activate the auto retune mode: The auto retune mode will not be started even if the SKIN (active low) = 'H' continues 30 seconds in the VF mode. The ALARM output is not effective.																			
VF SELECT	0	Does not select the VF mode.																			
	1	Selects the VF mode.																			
REMOCON	0	Does not select the Remote control function.																			
	1	Selects the Remote control function.																			
DK COUNT	0	Allows the DK signals to reach the LCTR pin and to be counted. This is effective only with the DIMRX VF SELECT = 1																			
	1	Disables the DK count. The DKcount is carried out inside the DK discriminator IC while the TRMRX DKIN is used for DC input.																			

*The SEEK operation jumps to the 9-kHz step mode from the manual mode.

diode matrix name	on /off	Functional Description																																																					
ANTI THEFT	0	Selects the ANTI-THEFT function.																																																					
	1	Does not select the ANTI-THEFT function.																																																					
POWER OFF CLOCK ON	0	Inactivates the clock display during off-power.																																																					
	1	Activates the clock display during off-power.																																																					
DIR DISPLAY	0	Enables the TAPE direction indication.																																																					
	1	Disables the TAPE direction indication.																																																					
TAPE IND This allows the indicated four characters to be displayed on the 7-segment panel, irrespective of clock mode selection.	0	The four characters T A P E are displayed on the 7-segment display panel.																																																					
	1	The 7-segment display is turned off in the order as shown below. The segment blanking starts from the segment marked by the upper-pointed arrow. The blanking speed from one segment to the next segment is 0.5sec. One of the 7 segments is always turned off while the operation continues in accordance with the directions indicated by the arrows.																																																					
		Display mode selection: In the FORWARD operation mode, PLAY = 0.5sec, FF = 125ms (with the TRMRX 'FF' = 'L'). In the REVERSE operation mode, REW = 125ms (with the TRMRX 'FF' = 'L').																																																					
Display mode selection: In the REVERSE operation mode, PLAY = 0.5sec, FF = 125ms (with the TRMRX 'FF' = 'L'). In the FORWARD operation mode, REW = 125ms (with the TRMRX 'FF' = 'L').																																																							
DOUBLE FUNCTION0 FUNCTION1 FUNCTION2	The DOUBLE FUNCTION keys available in the RADIO and TAPE modes are shown in the table below. keys M4, M5 and M6 have their own purposes. The '-' in the table indicates that no DOUBLE FUNCTION is not assigned.																																																						
	<table border="1"> <thead> <tr> <th>FUNCTION2</th> <th>FUNCTION1</th> <th>FUNCTION0</th> <th>M4</th> <th>M5</th> <th>M6</th> </tr> </thead> <tbody> <tr> <td>0</td> <td>0</td> <td>0</td> <td>APS</td> <td>NR</td> <td>MTL</td> </tr> <tr> <td>0</td> <td>0</td> <td>1</td> <td>-</td> <td>-</td> <td>-</td> </tr> <tr> <td>0</td> <td>1</td> <td>0</td> <td>-</td> <td>APS</td> <td>MTL</td> </tr> <tr> <td>0</td> <td>1</td> <td>1</td> <td>-</td> <td>-</td> <td>MTL</td> </tr> <tr> <td>1</td> <td>0</td> <td>0</td> <td>-</td> <td>-</td> <td>APS</td> </tr> <tr> <td>1</td> <td>0</td> <td>1</td> <td>-</td> <td>-</td> <td>NR</td> </tr> <tr> <td>1</td> <td>1</td> <td>0</td> <td>-</td> <td>NR</td> <td>MTL</td> </tr> <tr> <td>1</td> <td>1</td> <td>1</td> <td>-</td> <td>APS</td> <td>NR</td> </tr> </tbody> </table>		FUNCTION2	FUNCTION1	FUNCTION0	M4	M5	M6	0	0	0	APS	NR	MTL	0	0	1	-	-	-	0	1	0	-	APS	MTL	0	1	1	-	-	MTL	1	0	0	-	-	APS	1	0	1	-	-	NR	1	1	0	-	NR	MTL	1	1	1	-	APS
FUNCTION2	FUNCTION1	FUNCTION0	M4	M5	M6																																																		
0	0	0	APS	NR	MTL																																																		
0	0	1	-	-	-																																																		
0	1	0	-	APS	MTL																																																		
0	1	1	-	-	MTL																																																		
1	0	0	-	-	APS																																																		
1	0	1	-	-	NR																																																		
1	1	0	-	NR	MTL																																																		
1	1	1	-	APS	NR																																																		
FKEY 0 FKEY 1	In the TAPE mode, keys HA and MA can be used for APS, NR and MTL. However, those keys are not effective in the RADIO mode. The HA and MA functions are effective during the clock display with the DIMRX 'CLOCK' = 0.																																																						
	<table border="1"> <thead> <tr> <th>FKEY1</th> <th>FKEY0</th> <th>HA</th> <th>MA</th> </tr> </thead> <tbody> <tr> <td>0</td> <td>0</td> <td>-</td> <td>-</td> </tr> <tr> <td>0</td> <td>1</td> <td>APS</td> <td>NR</td> </tr> <tr> <td>1</td> <td>0</td> <td>MTL</td> <td>NR</td> </tr> <tr> <td>1</td> <td>1</td> <td>APS</td> <td>-</td> </tr> </tbody> </table>		FKEY1	FKEY0	HA	MA	0	0	-	-	0	1	APS	NR	1	0	MTL	NR	1	1	APS	-																																	
FKEY1	FKEY0	HA	MA																																																				
0	0	-	-																																																				
0	1	APS	NR																																																				
1	0	MTL	NR																																																				
1	1	APS	-																																																				

Transistor Matrix (TRMRX) Input

'H' and 'L': Transistor base polarities

	Active logic	Functional Description												
TAPÉ	L	Selects the TAPE mode.												
	H	Selects any other mode than the TAPE mode.												
CDIN	L	Selects the CD mode. The CD is given the highest priority. The prioritization is: RADIO mode < TAPE mode < CD mode.												
	H	Selects any other mode than the CD mode.												
FF/REW	L	Controls the DIRECTION indication in the TAPE mode with the DIMRX 'DIR DISPLAY' = 0, as shown below. <table border="1" style="margin: 10px auto;"> <thead> <tr> <th></th> <th>FORWARD</th> <th>REVERSE</th> </tr> </thead> <tbody> <tr> <td>PLAY (FF, REW="H")</td> <td style="text-align: center;">▶</td> <td style="text-align: center;">◀</td> </tr> <tr> <td>REW (FF="H", REW="L")</td> <td style="text-align: center;">2 Hz flash ◀▶</td> <td style="text-align: center;">2 Hz flash ▶◀</td> </tr> <tr> <td>FF (FF="L", REW="H")</td> <td style="text-align: center;">2 Hz flash ▶</td> <td style="text-align: center;">2 Hz flash ▶</td> </tr> </tbody> </table>		FORWARD	REVERSE	PLAY (FF, REW="H")	▶	◀	REW (FF="H", REW="L")	2 Hz flash ◀▶	2 Hz flash ▶◀	FF (FF="L", REW="H")	2 Hz flash ▶	2 Hz flash ▶
		FORWARD	REVERSE											
PLAY (FF, REW="H")	▶	◀												
REW (FF="H", REW="L")	2 Hz flash ◀▶	2 Hz flash ▶◀												
FF (FF="L", REW="H")	2 Hz flash ▶	2 Hz flash ▶												
SKIN	L	If this signal becomes active in the FM mode with the DIMRX 'VF SELECT' = 1, the SK display is turned on. This has nothing to do with the VF mode ON/OFF state. When the VF key is pressed, the SKIN = 'L' is searched immediately. If the SKIN signal is active about 250ms later after the SD signal is detected, that channel will be selected. The auto retune operation will be started if the SKIN remains 'H' 30 seconds (this signal is checked every 25ms). In this mode, the SKIN signal (active low) of M1-M6 is checked. If no SKIN signal is found, the next SKIN = 'L' will be searched for.												
DKIN	L	If this signal becomes active three times (checked every 25ms) in the VF, TAPE or CD mode with the DIMRX 'DK COUNT' = 1, the RADIO mode will be selected allowing the ARI broadcast to be received. This applies to the Europe specification only. The DK check will start in 3 seconds if the SKIN = 'L' is detected after the SK SEEK operation.												

Source Select Port

The OUT pins to select sources are set as shown below according to the modes. These outputs can be used to select the desired sound source.

0 = "L" 1 = "H"

VF	Mode		out pin	R̄	T̄	C̄	AM/FM	VF/ML	CDOUT
off	Normal		RADIO	0	1	1	1/0	0	0
			TAPE	1	0	1	1/0	0	0
			CD	1	1	0	1/0	0	1
on	DK standby	SK mode	RADIO	0	1	1	0	1	0
			TAPE	1	0	1	0	1	0
			CD	1	1	0	0	1	1
		PS SCAN	RADIO	0	1	1	0	1	0
			TAPE	0	1	1	0	1	0
			CD	0	1	1	0	1	1
	SK mode Radio monitor	RADIO	0	1	1	0	1	0	
		TAPE	0	1	1	0	1	0	
		CD	0	1	1	0	1	1	
DK mode		RADIO	0	1	1	0	1	0	
		TAPE	0	1	1	0	1	0	
		CD	0	1	1	0	1	1	

LCD Display Pattern

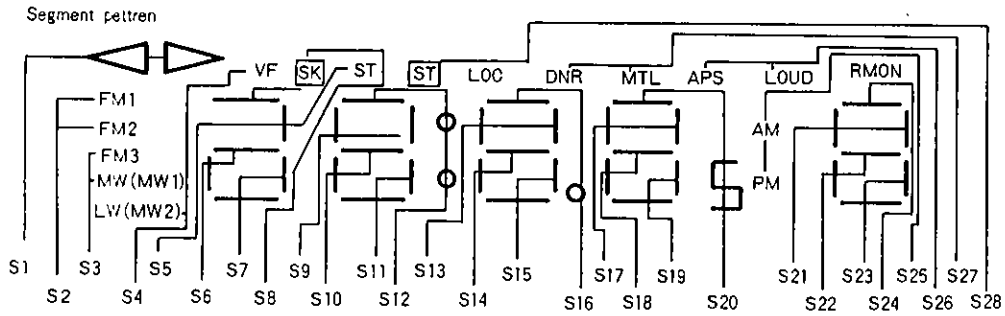
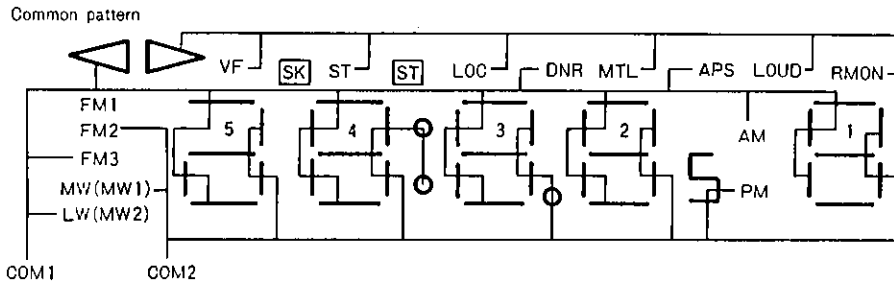

	COM1	COM2		COM1	COM2
S1	◀	▶	S15	3 d	3 c
S2	FM1	FM2	S16	3 a	d p
S3	FM3	MW(MW1)	S17	2 f	2 b
S4	LW(MW2)	VF	S18	2 e	2 g
S5	ST	5 b	S19	2 d	2 c
S6	5 e	5 g	S20	2 a	5
S7	5 d	5 c	S21	1 f	1 b
S8	5 a	SK	S22	1 e	1 g
S9	4 f	4 b	S23	1 d	1 c
S10	4 e	4 g	S24	1 a	RMON
S11	4 d	4 c	S25	AM	PM
S12	4 a	colon	S26	APS	LOUD
S13	3 f	3 b	S27	DNR	MTL
S14	3 e	3 g	S28	ST	LOC

Sanyo standard panel
LCD-8162JP

Display Examples

RADIO mode: FM frequency display

87.5₅ 3

VF mode: DK on FM frequency display

106.1 4

RADIO mode: AM frequency display

1720 6

TAPE mode: 12-hour clock display

12:00

TAPE mode: TAPE display and NR B

TAPPE b

TAPE mode: 24-hour clock display and NR B

23:00 b

TAPE mode: TAPE run display and NR C

c _ c C

CD mode: CD display ; DIMRX 'CLOCK' = 1

Cd

ANTI THEFT mode: factory mode entry indication and blinking

SECF

ANTI THEFT mode: P.C. code registration and blinking

PC

ANTI THEFT mode: personal code entry indication and blinking

SECP

RADIO mode: 'P' blinks when the **ME** key is pressed.

89.5 P

Key Description

(1) **M1** to **M6** and **ME**

(a) RADIO mode

These keys are used to carry out 'preset memory' write and read operations.

- Slow type (DIMRX 'MEMORY TYPE' = 0)

If any of **M1** to **M6** keys is turned off within a 1.5 seconds, the memory data that corresponds to that key will be read. If it is pressed continuously for more than 1.5 seconds, the frequency currently displayed will be written to the memory.

- **ME** key type (DIMRX 'MEMORY TYPE' = 1)

If the **ME** key is pressed, the P character (indicating the preset channel) will be flashing at a cycle of 2Hz. This means that data can be written to the preset memory. If any key of **M1** to **M6** is pressed in this situation within 5 seconds, the frequency currently displayed will be written.

If any other key is pressed or the HOLD (active low) signal becomes active within the 5 seconds, the write status will be released.

(b) TAPE mode

In the TAPE mode, keys M4 to M6 can be used as the TAPE keys.

Through the DIMRX selection, the following DOUBLE FUNCTION keys becomes available. Each key (M4 through M6) has their own function. The DOUBLE FUNCTIONS marked by the '-' are not supported.

FUNCTION2	FUNCTION1	FUNCTION0	M 4	M 5	M 6
0	0	0	APS	NR	MTL
0	0	1	-	-	-
0	1	0	-	APS	MTL
0	1	1	-	-	MTL
1	0	0	-	-	APS
1	0	1	-	-	NR
1	1	0	-	NR	MTL
1	1	1	-	APS	NR

(c) VF mode

During the TAPE and RADIO operation under the VF mode, keys **M1** through **M6** can be used for tuning.

(d) Clock update with the **ME** key (DIMRX 'MEMORY TYPE' =1)

The clock update can be performed by pressing the **HA** and **MA** (or the **M1** and **M2**) while holding down the **ME** key.

This function is effective only when the **HOLD** (active low) becomes inactive (or at the POWER on).

(2) **HA** and **M1**

These keys are used to update the 'HOUR' value. However, note that they only allow the value to increase. If they are pressed once, the value will be incremented by 1 (one hour). If they are pressed continuously for more than 500ms, the value will increase at a speed of 4 (hours) per second. These keys do not affect the minute and second data display. If the **ME** key is used, these keys should be pressed synchronously with it. If it is not used, they should be pressed synchronously with the **DISPLAY** key.

This function is effective only when the clock display is active.

In the TAPE mode, the **HA** key can be assigned to the **APS** or the **MTL**.

(3) **MA** and **M2**

These keys are used to update the 'minute' value. However, note that they only allow the value to increase. If they are pressed once, the value will be incremented by 1. If they are pressed continuously for more than 500ms, the value can be increased at a speed of 8 (minutes) per second. In this case, the 'second' value is reset to 0. There will be no carry from the minute data. If the **ME** key is used, they should be pressed synchronously with it. If the **ME** key is not used, they should be used together with the **DISPLAY** key. This function is effective only when the clock display is active.

In the TAPE mode, the **MA** key can be assigned to the **NR**.

Keys **HA** and **MA** can have the following functions through the DIMRX 'FKEY0,1' manipulation.

FKEY1	FKEY0	HA	MA
0	0	-	-
0	1	APS	NR
1	0	MTL	NR
1	1	APS	-

(4) **UP** and **DOWN**

These keys are used for manual tuning. If they are pressed once, the current frequency value can be decreased (DOWN) or increased (UP) one step. If they are pressed continuously for more than 500ms, the value will change at a step of about 70ms. The system will enter a wait state of about 500ms when the frequency value has reached a band edge.

In the VF mode, they can be used as the **SEEK UP,DOWN** keys.

These functions are effective only when the **HOLD** signal (active low) becomes inactive or at the POWER on.

(5) **SEEK UP** and **SEEK DOWN**

These keys are used for automatic station searching. If the desired station is searched, its frequency is held. If the **SCAN** key is pressed during the seek operation, the SCAN mode will be activated. This means that if the **SEEK UP** key is pressed during the **SEEK DOWN** operation, the scan operation in the UPward direction is started. If the **SEEK DOWN** key is pressed during the **SEEK UP** operation, the scan operation in the DOWNward direction will started as well.

If these keys are pressed twice in a row, the SEARCH mode will be released. The system will enter a wait state of about 500ms when the search operation has reached a band edge. The search speed is 50ms/step for FM, or 70ms/step for AM.

These functions are effective only when the **HOLD** signal (active low) becomes inactive or at the POWER on.

(6) **SCAN**

This key is used for automatic station searching. If the desired station is searched, its frequency is held for 5 seconds (**AMUTE** (active low) = 'H'). If the key is pressed again during this 5-second period, the frequency is officially held. If no action is taken during that 5-second period, the system will continue the search operation. If the **SEEK DOWN** key is pressed during the scan operation, the seek operation in the DOWNward direction will be started. If this key is pressed twice in a row, the SCAN mode will be released. The system will enter a wait state of about 500ms if the search operation has reached a band edge. The search speed is 50ms/step for FM, or 70ms/step for AM.

This key is effective only when the **HOLD** signal (active low) becomes inactive or at the POWER on.

(7) **BAND**

This key is used to select the desired frequency band. The current band value will be changed every time when this key is pressed.

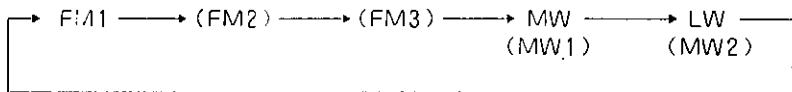

This key is effective only when the **HOLD** signal (active low) becomes inactive or at the POWER on.

(8) **VF**

This key is used to activate the VF mode for FM band. It can be used in any band under the RADIO mode. When this key is pressed, the 'VF' display will be turned on and the VFOUT output will change to 'H'. In this situation, the SD signal will be checked 300ms later. In addition, the **SKIN** signal (active low) will be checked 250ms (750ms if bands are changed) later. If the SKIN signal is active, the frequency is held. If it is inactive ('H'), the system will start auto search operation for the SK station, and then keep a frequency at the moment when the **SKIN** signal (active low) becomes active.

The SK display in the Europe and FM modes is turned on when the **SKIN** signal (active low) becomes active. It has nothing to do with the VF function.

key	Display status		Output status
VF	VF	ON	H
		OFF	L

The **VF** and **SEEK** keys perform the following functions according to the VF modes and **SKIN** signal (active low) levels:

VF (VF mode)	SKIN	If VF is pressed.	If SEEK is pressed.	If the same SEEK key is pressed during a seek operation.	If the VF key is pressed during a seek operation.
off	H	The VF mode is activated and the SK station search is then started.	The normal station search is started.	The current search operation stops immediately.	The VF mode is activated and the SK station search is then started.
off	L	The VF mode is activated.	Same as above	Same as above	Same as above
on	H/L	The VF mode is inactivated.	The SK station search is started.	The SEEK operation continues.	The VF mode is inactivated and the previous state is restored.

- If the **[VF]** key is pressed in the TAPE or CD mode (with the VF mode not activated), the following operations can be performed according to the $\overline{\text{SKIN}}$ and $\overline{\text{DKIN}}$ (active low each) signal levels:

	$\overline{\text{SKIN}}$	$\overline{\text{DKIN}}$	If the [VF] key is pressed in the TAPE or the CD mode (VF mode OFF to ON)	mode	$\overline{\text{R}}$	$\overline{\text{T}}$	$\overline{\text{C}}$	AM/FM
				①	H	H	The frequency is displayed and the $\overline{\text{SKIN}}$ signal SEEK UP operation is started. If the $\overline{\text{SKIN}} = 'L'$ is detected, the display mode is changed to the TAPE or the CD mode display. The system goes to (3) if it detects the $\overline{\text{DKIN}} = 'L'$.	TAPE mode
				CD mode	H	H	L	L
②	L	H	The system continues the TAPE or the CD mode display. It goes to (3) if it detects the $\overline{\text{DKIN}} = 'L'$. The system starts the retuning operation and then checks the $\overline{\text{SKIN}}$ signal (active low) of M1-M6 if the $\overline{\text{SKIN}}$ signal becomes inactive 30 seconds (checked every 25 seconds) with the DIMRX 'VF AUTORETUNE' = 0. If no $\overline{\text{SKIN}}$ signal is detected, the system starts the SEEK UP operation.	TAPE mode	H	L	H	L
				CD mode	H	H	L	L

	$\overline{\text{SKIN}}$	$\overline{\text{DKIN}}$	Operations	$\overline{\text{R}}$	$\overline{\text{T}}$	$\overline{\text{C}}$	AM/FM
③	L	L	The system enters the frequency display mode and then starts the ARI broadcast.	L	H	H	L

- If the **[VF]** key is pressed (VF mode OFF to VF mode ON) in the RADIO MONITOR mode, the RADIO MONITOR mode is released and operation (1) or (2) will be then started.
- The $\overline{\text{SKIN}}$ signal (active low) is checked for 3 seconds at the POWER on (or when the $\overline{\text{HOLD}}$ signal (active low) changes to 'H' from 'L'). If it remains 'H' during the 3-second period, the retuning operation is started. In this case, the $\overline{\text{SKIN}}$ signal (active low) of M1-M6 will be checked. If it is not detected, the SEEK UP operation will be started.
 - The above operations can be performed only if the $\overline{\text{HOLD}}$ signal (active low) is active or at the POWER on.
 - The VF mode can be released by pressing the **[VF]** or the **[BAND]** key. However, the **[BAND]** key is not effective in the TAPE mode ($\overline{\text{TAPE}}$ signal (active low) = 'L'), CD mode and RADIO MONITOR mode.

The state diagram for the VF mode is shown below.

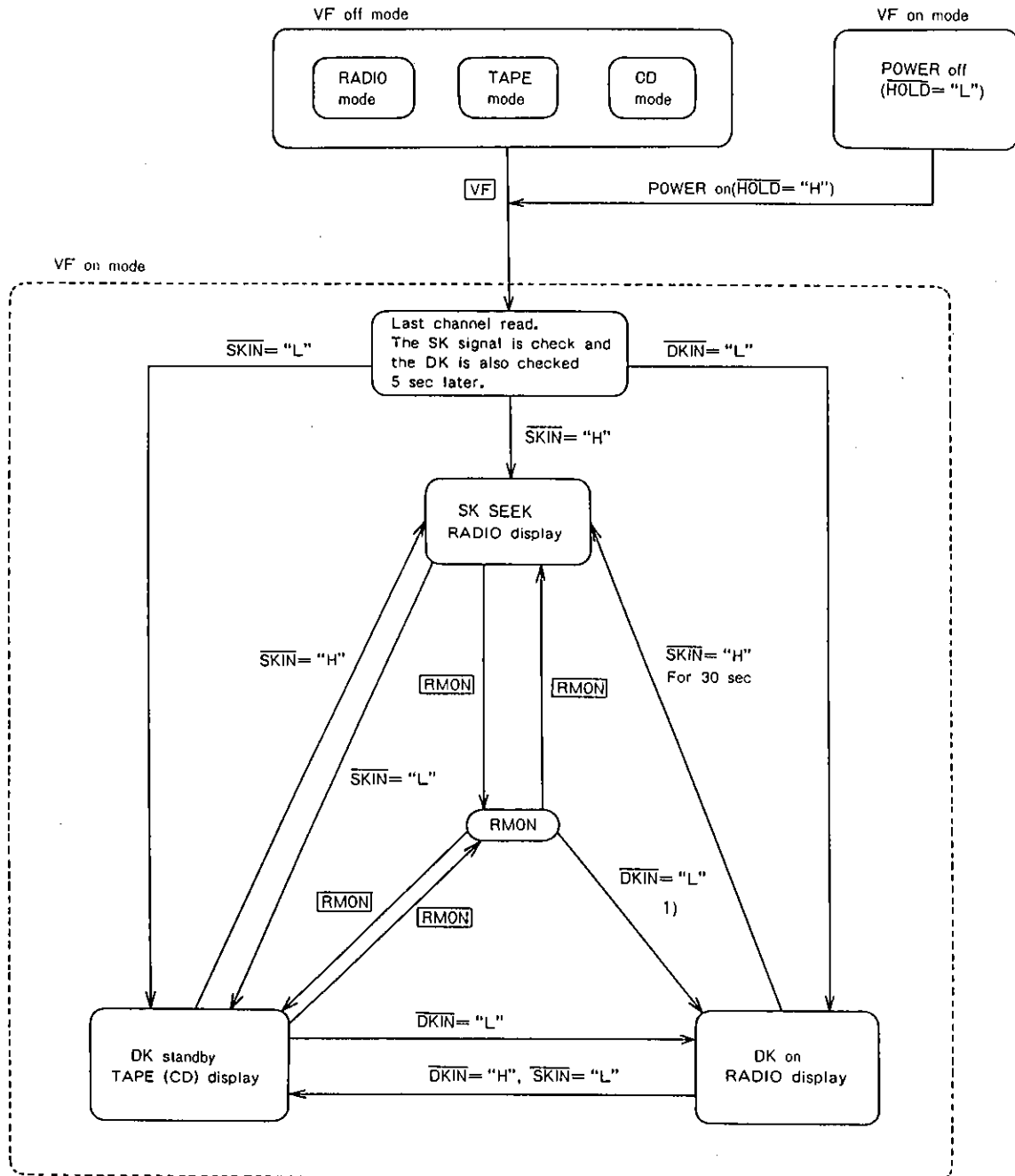

- Notes: 1) The RADIO MONITOR is released.
 2) indicates a key.
 3) If the VF mode is changed to ON from OFF during the RADIO MONITOR mode, the monitor mode will be released.

(9) **PS/AMEM**

This key is used to perform two different functions. If it is pressed for less than 2 seconds, the PS (Preset Scan) mode will be started. If it is pressed for more than 2 seconds, the AMEM (Auto store MEMory) mode will be started.

This key is effective only when the $\overline{\text{HOLD}}$ signal (active low) becomes active or at the POWER on.

(a) PS (Preset Scan) operation

If this key is pressed, the channel number currently display will be incremented sequentially. If no channel number is displayed currently, the increment will start from channel number 1. If the desired station is encountered, the $\overline{\text{AMUTE}}$ (active low) becomes inactive for five seconds. The LOC/DX is set to the DX unconditionally. The channel number display blinks at a cycle of 1Hz during the PS operation. If this key is pressed twice in a row, the PS mode will be released.

The PS mode can be released by pressing any one of the following keys:

PS/AMEM, **SEEK UP**, **SEEK DOWN**, **SCAN**, **UP**, **DOWN**, **M1** to **M6**, **POWER**, **BAND** and **VF**.

In addition, the PS mode can be released when the $\overline{\text{HOLD}}$ signal (active low) becomes active, and TAPE or CD mode is started.

The Preset Scan direction is determined by the DIMRX 'FMB0, FMB1, B0- B2', as shown below:

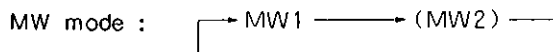
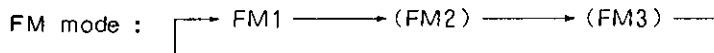

(b) AMEM operation

• FM mode

Channels are stored to M1 to M6 in this order according to the intensities of electric field (ADI pin input).

[FM1, FM2 and FM3 selection mode] (DIMRX 'FMB0, 1' = 0,0)

: If the FM1 band is first selected, channel storage starts from the M1 of the FM1 to the M6 of the FM3. → 18 channels

: If the FM2 band is first selected, channel storage starts from the M1 of the FM2 to the M6 of the FM3. → 12 channels

: If the FM3 band is first selected, channel storage starts from the m1 of the FM3 to the M6 of the FM3. → 6 channels

[FM1 and FM2 selection mode] (DIMRX 'FMB0,1 = 1,0)

: If the FM1 band is first selected, channel storage starts from the M1 of the FM1 to the M6 of the FM2. → 12 channels

: If the FM2 band is first selected, channel storage starts from the M1 of the FM2 to the M6 of the FM2. → 6 channels

[FM1 only selection mode] (DIMRX 'FMB0,1 = 0, 1)

: If the FM1 band is selected, channel storage starts from the M1 of the FM1 to the M6 of the FM1. → 6 channels

[VF selection mode] (DIMRX 'VF SELECT' = 1)

: If the VF band is selected, channel storage starts from the M1 of the VF to the M6 of the VF. → 6 channels

• MW and LW modes

Place the system in the LOCAL mode by setting the LOC pin level to 'H'. Then, start the channel storage from M1. If some of the M1 to M6 are not used for channel storage, change the LOC pin level to 'L' to activate the DX mode and then store channels to the remaining memories.

• None-LW mode (MW1 and MW2)

If the MW1 band is first selected, channel storage starts from the M1 of the MW1 to the M6 of the MW2. → 12 channels

If the MW2 band is first selected, channel storage starts from the M1 of the MW2 to the M6 of the MW2. → 6 channels

During the auto store operation under any band mode, the 'g' will be flashed at a cycle of 1Hz. If the entire channel storage area is not used up, the remaining preset channel area is left as is. In this case, channel '1' is read and then displayed.

The one of the following keys can be used to release the AMEM operation.

PS/AMEM, **POWER**, **BAND**, **VF**, and **CD**

In addition, this operation mode will be released when the $\overline{\text{HOLD}}$ signal (active low) becomes active, and TAPE or CD mode is started.

(10) **CD**

This key is used to start the CD mode. In this mode, the 'CD' display is turned on and the CDOUT output goes high.

key	Display status		Output status
CD	CD	Display ON	H
		Display OFF	L

When this key is pressed with the $\overline{\text{HOLD}}$ signal (active low) = 'H', the CD mode is activated immediately. The CD mode will be released when the $\overline{\text{HOLD}}$ signal changes from 'H', to 'L' and then to 'H' again, or when the POWER is turned on, turned off and then turned on again.

This key function is effective when the $\overline{\text{HOLD}}$ signal (active low) becomes inactive or at the POWER ON.

However, this function is not effective when the $\overline{\text{CDIN}}$ signal (active low) becomes active.

(11) **LOC**

This key is used in the RADIO mode. If this key is pressed, the 'LOC' display is turned on. In this situation, if the SEEK or the SCAN key is pressed, the LOC output goes high and the local search operation is then started. The LOC output goes low when the seek or the scan operation is released.

key	Display status		'Normal' output status	'Search' output status
LOC	LOC	Display ON	H	H
		Display OFF	L	L

This key function is effective when the $\overline{\text{HOLD}}$ signal (active low) becomes inactive or at the POWER ON.

(12) **LOUD**

If this key is pressed once, the 'LOUD' display is turned on and the LOUD output goes high. If it is pressed again, the 'LOUD' display is turned off and the LOUD output goes low.

key	Display status		Output status
LOUD	LOUD	Display ON	H
		Display OFF	L

This key function is effective when the $\overline{\text{HOLD}}$ signal (active low) becomes inactive or at the POWER ON.

(13) **DISPLAY**

This key is used in the clock mode (DIMRX 'CLOCK' = 0) to change the display information (clock and frequency, clock and TAPE display, and clock and CD display). This key can be used in every operation mode when the $\overline{\text{HOLD}}$ signal (active low) or at the POWER ON.

If the **ME** is not used (DIMRX 'MEMORY TYPE' = 0), this key can be used together with the **HA** or the **MA** key to change the clock data. This function is effective when the $\overline{\text{HOLD}}$ signal (active low) becomes inactive or at the POWER ON/OFF.

mode	DIMRX 'PRIORITY' = 0 (clock display priority mode)	DIMRX "PRIORITY" = 1
<p>RADIO mode</p>	<p>*RADIO key</p> <p>PS/AMEM, SEEK UP, SEEK DOWN, SCAN, UP, DOWN, M1 - M6, POWER, BAND, VF, LOC</p>	<p>If the RADIO key is pressed in the clock display mode, the frequency display is turned on within 5 sec.</p>
<p>TAPE mode</p>	<p>At the activation of the TAPE mode, the TAPE display is turned on 5 sec.</p>	
<p>CD mode</p>	<p>At the activation of the CD mode, the CD display is turned on 5 sec.</p>	
<p>VF mode</p>	<p>In the TAPE or CD mode</p> <p>Note: In this operation mode, the system finally enters the CLOCK display mode. This means that the TAPE running direction becomes unclear if the DIMRX 'DIR DISPLAY' has not been set to '0'.</p>	<p>Note: In the TAPE display mode or the FREQ display mode, the TAPE running direction becomes unclear if the DIMRX 'DIR DISPLAY' has not been set to '0'.</p>

(14) **RMON**

This key is used to activate the RADIO MONITOR mode temporarily. If the key is pressed in the TAPE or the CD operational mode, the 'RMON' display blinks at a cycle of 1Hz. During this blink mode, RADIO frequencies can be received. If this key is pressed again, the RADIO MONITOR mode will be released and the previous operational mode is restored.

key	Display status		Output status		
			\bar{R}	\bar{T}	\bar{C}
RMON	RMON	Display ON	L	H	H
		Display OFF	**	**	**

** : indicate the statuses that are prior to the activation of the RADIO MONITOR mode.

This key is effective in the DK wait (standby) state under the VF operational mode.

If the **VF** key is pressed (VF mode OFF to VF mode ON) in the RADIO MONITOR mode, the RADIO MONITOR mode is released and operation (1) or (2) will be then started.

	\overline{SKIN}	\overline{DKIN}	If the VF key is pressed in the TAPE or the CD mode (VF mode OFF to ON)	mode	\bar{R}	\bar{T}	\bar{C}	AM/FM
①	H	H	The frequency is displayed and the \overline{SKIN} signal SEEK UP operation is started. If the \overline{SKIN} = 'L' is detected, the display mode is changed to the TAPE or the CD mode display. The system goes to (3) if it detects the \overline{DKIN} = 'L'.	TAPE mode	H	L	H	L
				CD mode	H	H	L	L
②	L	H	The system continues the TAPE or the CD mode display. It goes to (3) if it detects the \overline{DKIN} = 'L'. The system starts the retuning operation and then checks the \overline{SKIN} signal (active low) of M1-M6 if the \overline{SKIN} signal becomes inactive 30 seconds (checked every 25 seconds) with the DIMRX 'VF AUTORETUNE' = 0. If no \overline{SKIN} signal is detected, the system starts the SEEK UP operation.	TAPE mode	H	L	H	L
				CD mode	H	H	L	L
③	L	L	Operations		\bar{R}	\bar{T}	\bar{C}	AM/FM
	L	L	The system enters the frequency display and then starts the ARI broadcast.		L	H	H	L

This function is effective only when the \overline{HOLD} signal (active low) becomes inactive or at the POWER ON.

(15) **POWER** (DIMRX 'POWER SW' = 1)

This key is used control the power supply with a key of the key matrix. If this key is pressed, the POWER pin level goes high. In this situation, if the TAPE is pressed, the TAPE mode will be activated while the CD mode will be active if the **CD** on (\overline{CDIN} signal (active low) = 'L') is pressed.

Power Supply Connection Examples

POWER key configuration (DIMRX 'POWER SW' = 1)

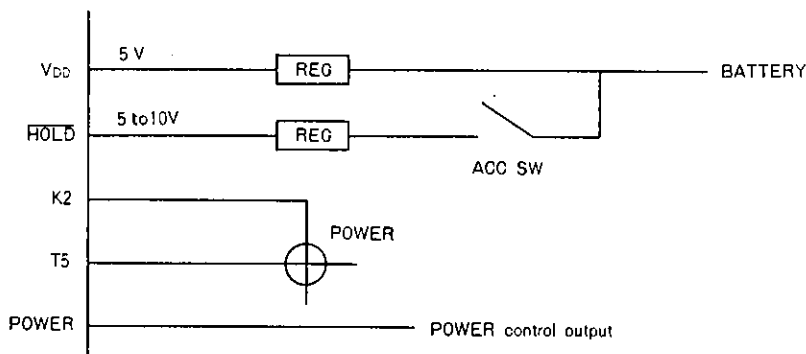

External POWER switch configuration (DIMRX 'POWER SW' = 0)

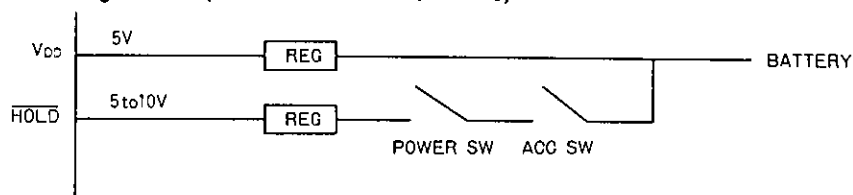

Remote Control Function (by the LC7461M-8103 application)

The remote control keys can be used to perform all the functions of the main unit keys.

	KO 0	KO 1	KO 2	KO 3	KO 4	KO 5	KO 6	KO 7
KI 0	0 : LOUD	4 : MO/ST	8 : VF	12 : BAND	16 : LOC	20 : DISPLAY	24 : —	28 : —
KI 1	1 : M1	5 : M4/MTL	9 : DOWN	13 : SEEK DN	17 : APS	21 : RMON	25 : ADJ *	29 : —
KI 2	2 : M2	6 : 4	10 : UP	14 : SEEK UP	18 : NR	22 : POWER	26 : HA *	30 : —
KI 3	3 : M3	7 : M6/APS	11 : SCAN UP	15 : CD	19 : PS/AMEM	23 : ME	27 : MA *	31 : —

*: not assigned.

In the remote control mode, the **ME** key cannot be used with the **M1**-**M6** keys at the same time. To write data to the system storage, press the ME key first and then press any of M1 through M6 keys.

* Keys **ADJ**, **HA** and **MA** are provided for exclusive use under the remote control mode. Keys APS and NR (17 and 18) perform only the APS and NR functions of the main unit keys **HA/APS** and **MA/NR**, respectively. If the **ADJ** key is pressed, the clock update mode will be activated and the display data will be flashing. If the key is pressed again, the clock update mode will be released.

These remote control keys are not effective under the ANTI THEFT operation mode.

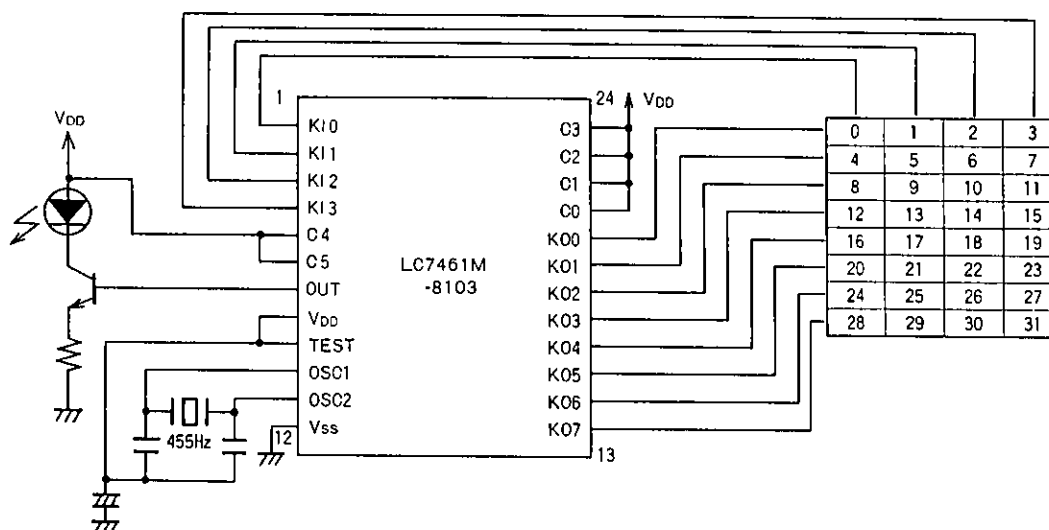

State Diagram

(1) No clock selection

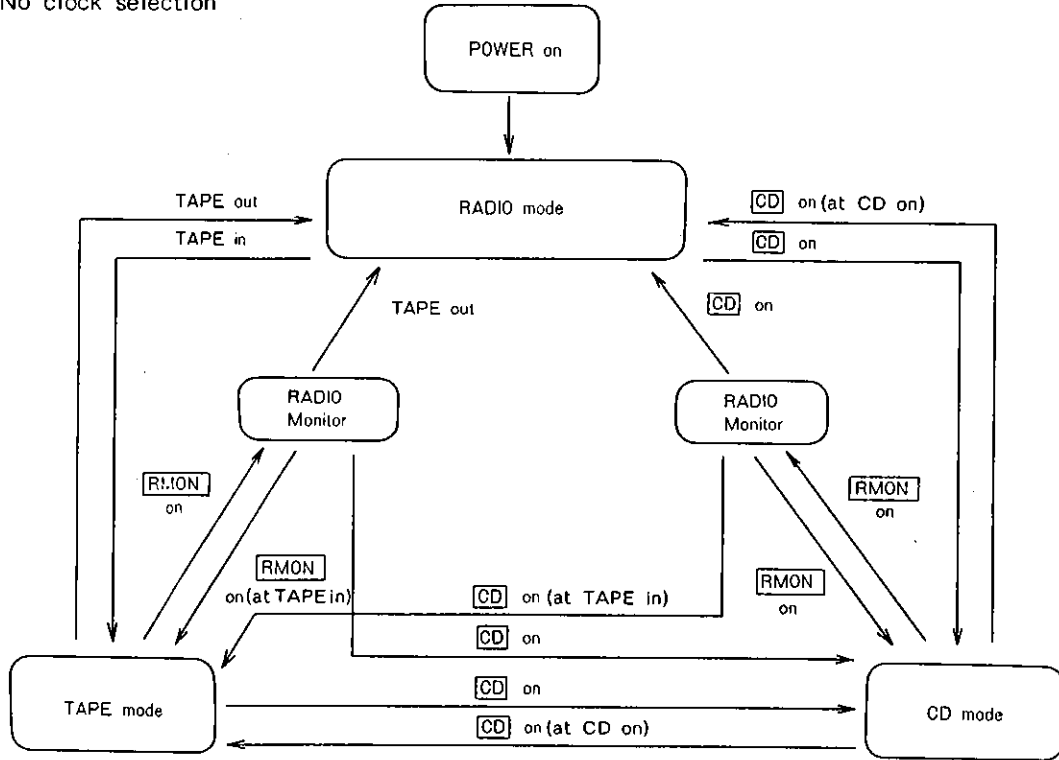

(2) Clock selection

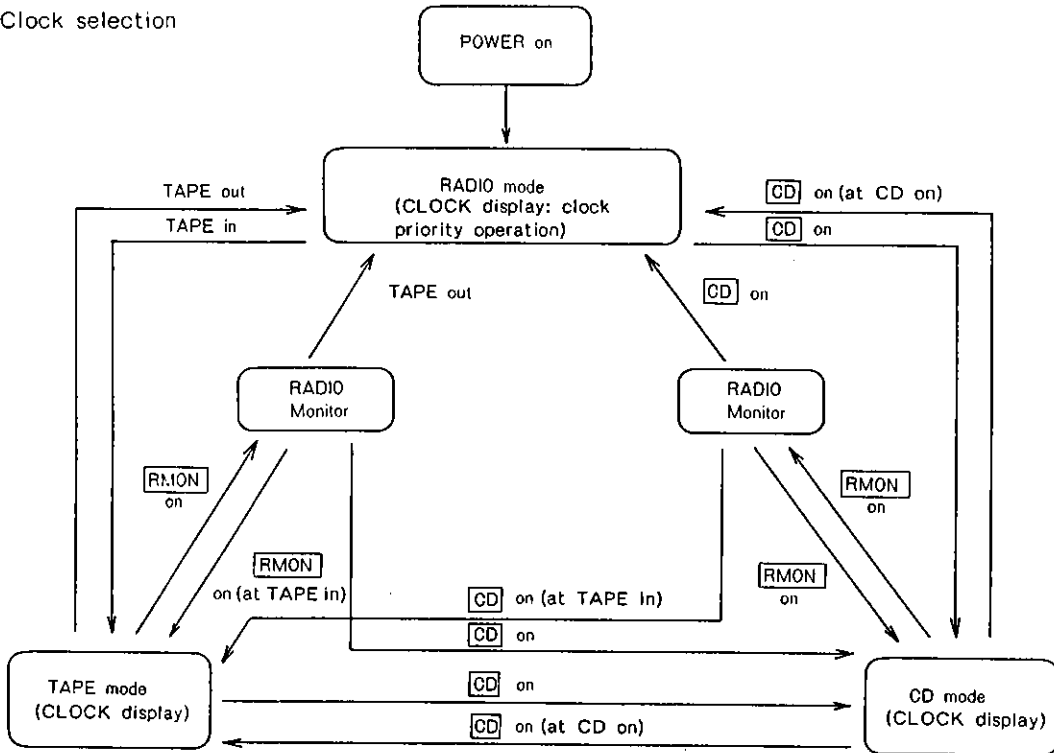

- Notes: 1) indicates a key.
 2) The 'CD on' is equivalent to the situation where the CDIN signal (active low) becomes active.

(3) VF mode on
No clock selection

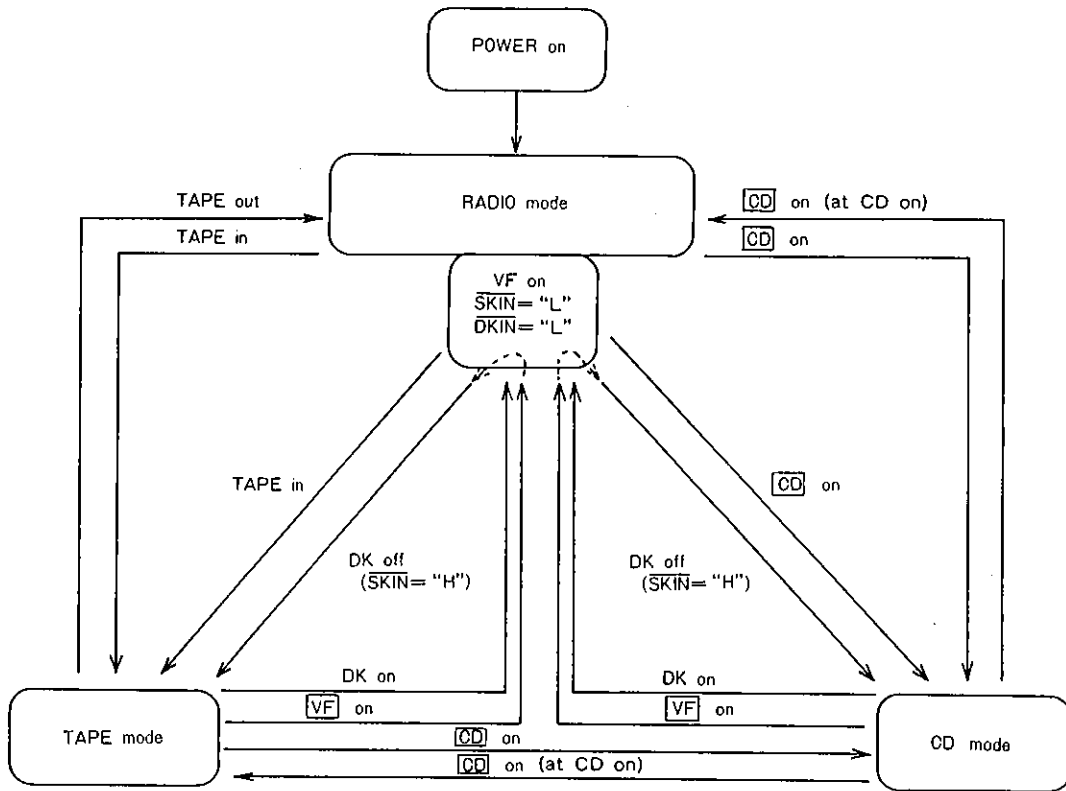

Note: RADIO monitor omitted

(4) VF mode on
Clock selection

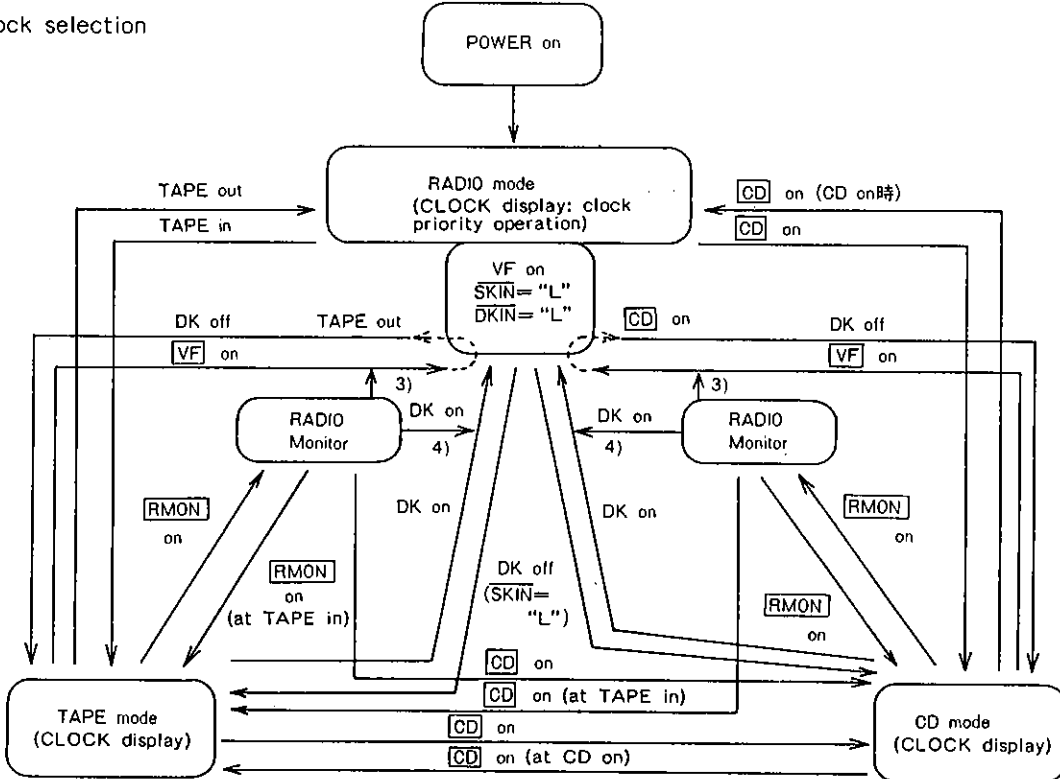

- Notes: 1) indicates a key.
 2) The 'CD on' is equivalent to the situation where the CDIN signal (active low) becomes active.
 3) If the 'VF' key is turned on with VF = off during the RADIO MONITOR operation, the RADIO MONITOR mode will be released and the VF mode will be then activated.
 4) If the 'DK on' is detected during the RADIO MONITOR operation, the RADIO MONITOR mode will be released and the SK broadcasting will be then started.

Timings

(1) SEEK, SCAN

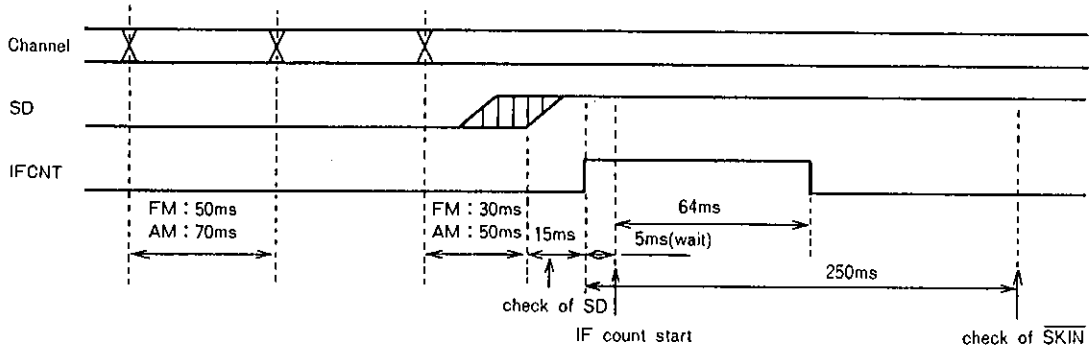

Notes: 1. IF count tolerance

FM	10.7MHz ± 10KHz
MW	450KHz ± 3KHz
LW	450KHz ± 0.6KHz

2. The SD is checked for 10ms in the IFcount mode. Otherwise, it is checked for 15ms.

(2) Manual UP and DOWN (applies to the FM and AM modes)

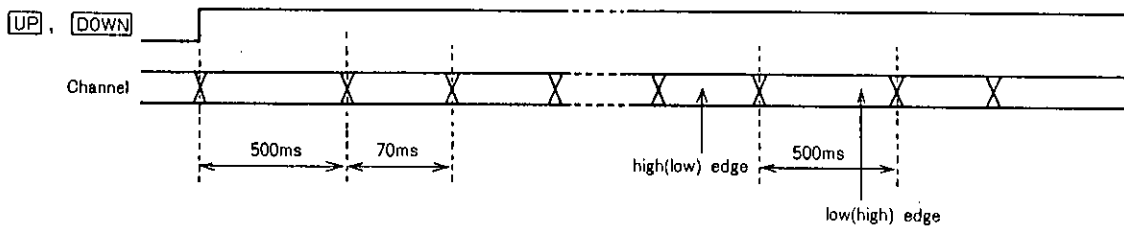

(3) VF auto retune

The retune operation will be started at the following timings if the SKIN signal (active low) remains inactive ('H') for more than 30 seconds under the VF mode.

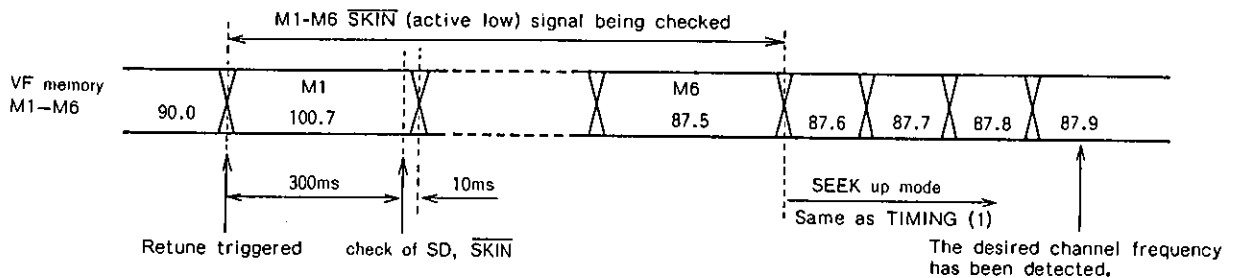

Note 1: The VF preset memory search operation is performed at the following timings:

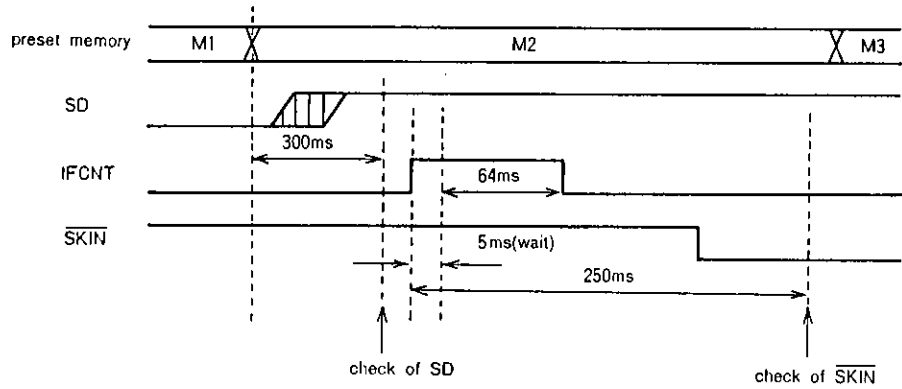

Note 2: If no SD is detected in the VF preset memory, the normal VF SEEK UP operation is started. In this case, it is carried out at the same timing as TIMING (1).

(4) LOC pin control

The SEEK, SCAN, AMEM and VF auto retune operations are performed as shown below during the 'LOC' display.

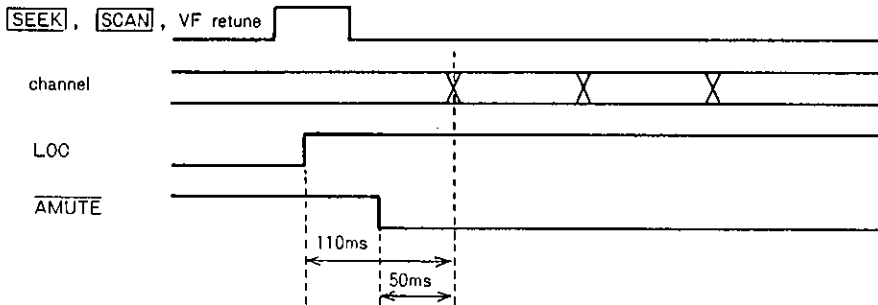

(5) SKIN signal (active low) check time at the VF mode change from OFF to ON

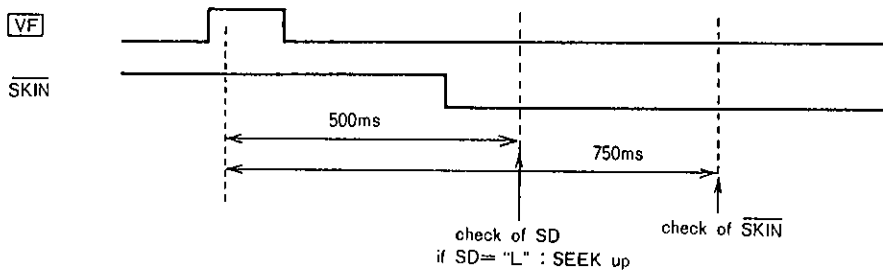

(6) Audio Mute (AMUTE: active low)

- (1) Key chattering reject time period (40ms)
- (2) Audio mute leading time and BEEP out (50ms)
- (3) PLL data and Display change processing (30ms to 50ms)
- (4) Audio mute trailing time

(a) BAND, M1 to M6, VF on → off

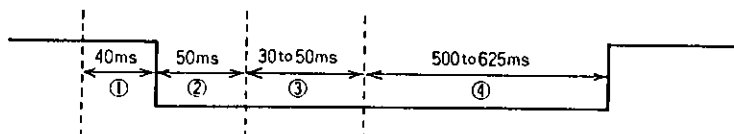

(b) VF OFF to VF ON (The case where the $\overline{\text{TAPE}}$ (active low) = 'L', $\overline{\text{CDIN}}$ = (active low) 'L', CD on is detected with DK signal inactive is not included)

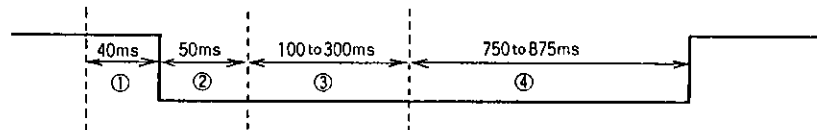

Note) Period ③ includes the check of the $\overline{\text{SKIN}}$ signal (active low).

(c) UP, DOWN

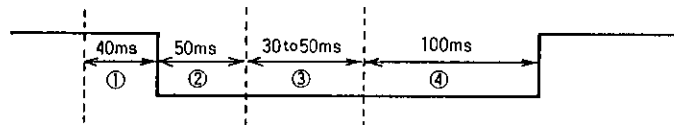

(d) PS (preset scan)

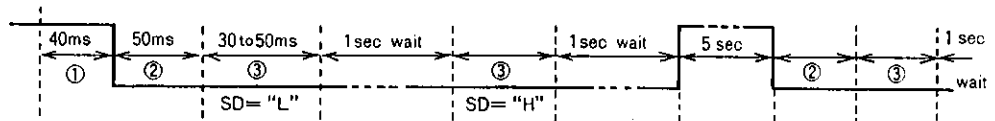

(e) AMEM, SEEK, SCAN

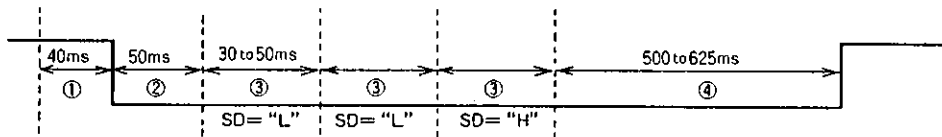

(f) VF auto retune

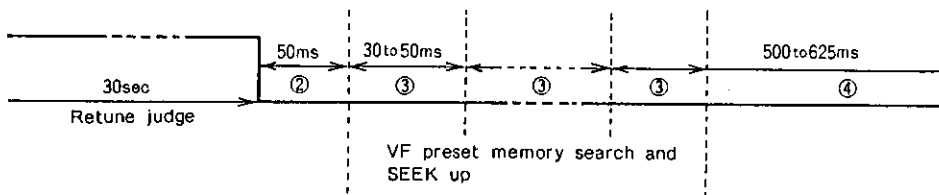

Note: The $\overline{\text{AMUTE}}$ signal (active low) is not output in the case where the DK signal is not detected but the $\overline{\text{TAPE}}$ signal (active low) or the $\overline{\text{CDIN}}$ signal (active low) becomes active, or the CD on is detected. This applies to (a) to (f). Note that the $\overline{\text{AMUTE}}$ signal is output at the BAND selection of (a).

(7) Mode change

(a) The modes are changed in the following cases:

- RADIO on
- RADIO monitor on/off
- TAPE in/out
- **CD** on/off
- CDIN = 'H' → 'L' → 'H'

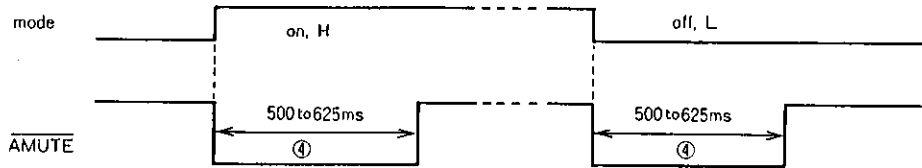

(b) VF off → on (TAPE and CD in)

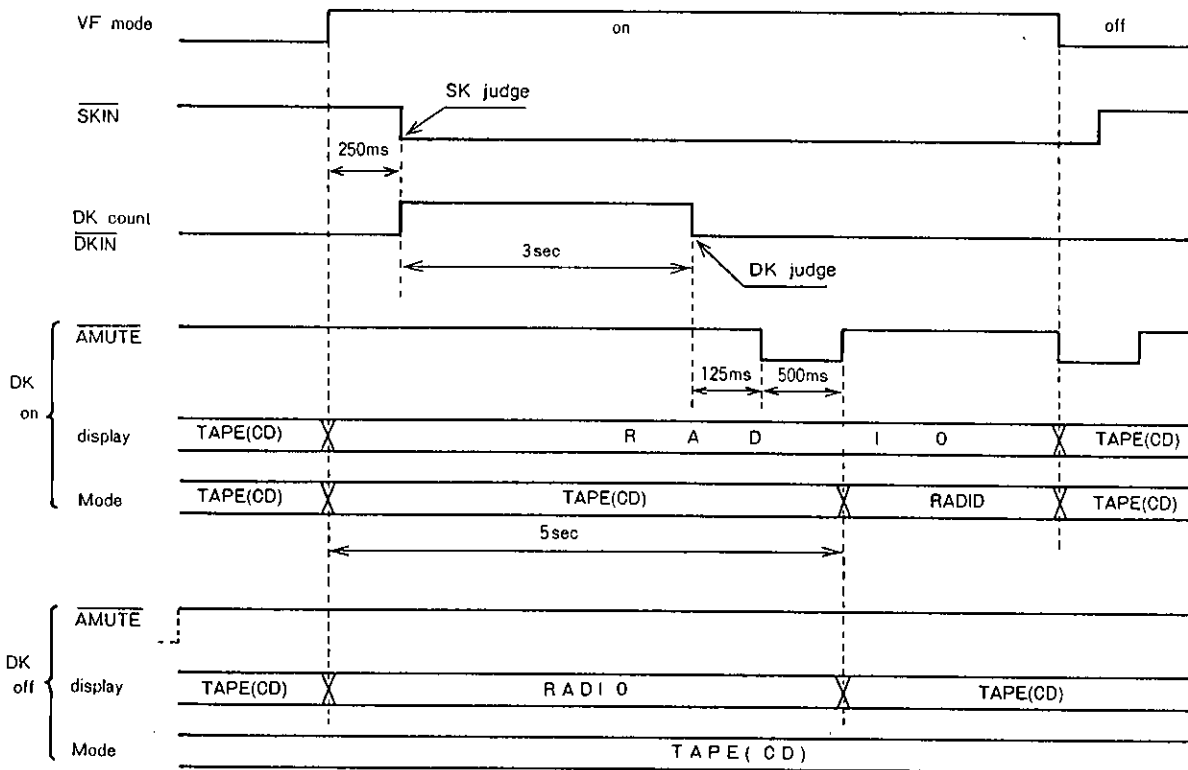

(8) Timings for **SK** display with the $\overline{\text{SKIN}}$ signal (active low) and **ST** display with the STEREO signal (active low) under the FM RADIO mode or the VF mode, and Timing for TAPE running direction display with the DIR signal.

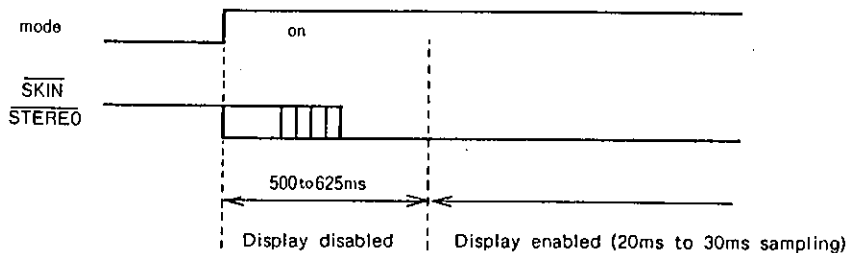

(9) ALARM output (VF mode)

The ALARM signal is output when the SKIN signal (active low) remains inactive continuously for 30 seconds. At the same time, the SEEK UP operation will be started. (DIMRX 'VF AUTORETUNE' = 0)

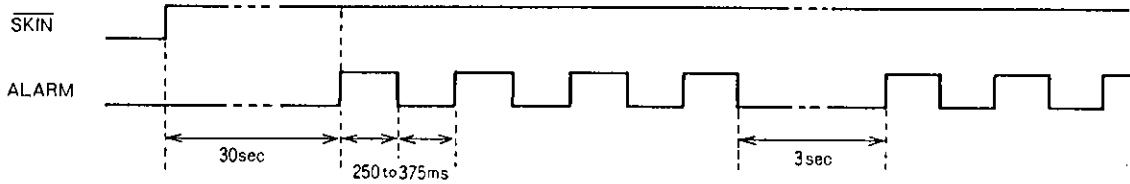

(10) HOLD mode

The HOLD mode means a status where only the clock block is in the active state. This mode is activated when the HOLD signal (active low) changes from 'H' to 'L'. In this mode, the input to the FMIN, AMIN, HCTR, LCTR and ADI pins is inhibited.

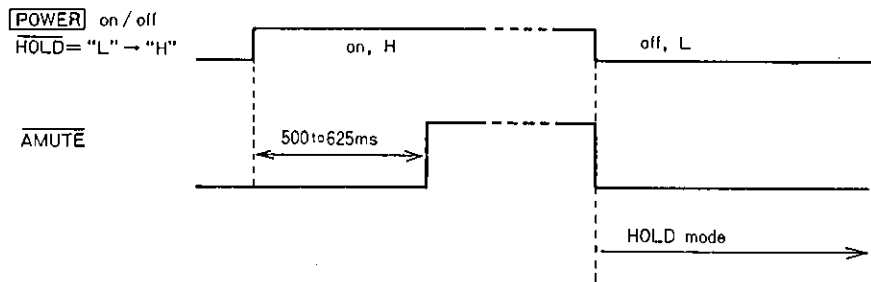

(11) BACK UP mode

The BACK UP mode means a status where the 4.5MHz X'tal oscillation circuitry is in the inactive state and the POWER SAVE mode is activated. This mode is activated when the HOLD signal (active low) changes from 'H' to 'L'. In this mode, the input to the FMIN, AMIN, HCTR, LCTR and ADI pins is inhibited.

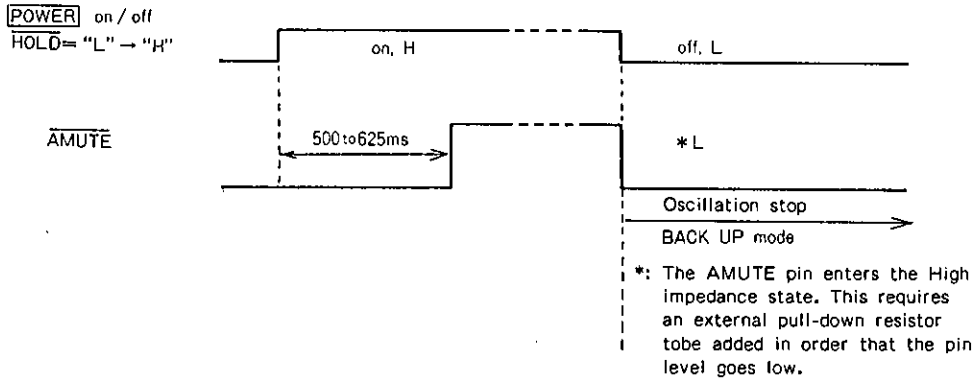

Initial Status

RADIO mode	TAPE mode	POWER on, HOLD = "H"
<ul style="list-style-type: none"> • band ...FM1 (low band edge) • MO/ST...mono • VF ...off • LOC ...DX(off) 	<ul style="list-style-type: none"> • NR B, NR C...off • APSoff • MTLoff 	<ul style="list-style-type: none"> • CD off • LOUD ...off • RADIO monitor ...off

Tracking Point Frequency

Area	Band	M1	M2	M3	M4	M5	M6	last channel
USA	FM a, b	87.5	90.1	98.1	106.1	107.9	87.5	87.5
	MW a	530	600	1000	1400	1720	530	530
	MW b	530	600	1000	1400	1620	530	530
	MW c	531	603	999	1404	1620	531	531
	MW d	531	603	999	1404	1719	531	531
EUROPE	FM c, d	87.5	90.0	98.0	106.0	108.0	87.5	87.5
	MW c	531	603	999	1404	1620	531	531
	MW e	522	603	999	1404	1620	522	522
	LW a	153	160	200	260	281	153	153
	LW b	146	160	200	260	290	146	146
JAPAN	FM e	76.0	78.6	83.0	86.6	90.0	76.0	76.0
	MW f	522	603	999	1404	1629	522	522
S. ALABIA	FM b	87.5	90.1	98.1	106.1	107.9	87.5	87.5
	MW g	531	603	999	1404	1602	531	531
SOUTH AFRICA	FM f	87.5	90.1	98.1	106.1	107.9	87.5	87.5
	MW g	531	603	999	1404	1602	531	531
EAST EUROPE	FM g	64.0	74.0	84.0	94.0	104.0	64.0	64.0
	MW h	522	603	999	1404	1620	522	522

The low band edges are loaded into the FM2, FM3 and MW2.

- No products described or contained herein are intended for use in surgical implants, life-support systems, aerospace equipment, nuclear power control systems, vehicles, disaster/crime-prevention equipment and the like, the failure of which may directly or indirectly cause injury, death or property loss.
- Anyone purchasing any products described or contained herein for an above-mentioned use shall:
 - ① Accept full responsibility and indemnify and defend SANYO ELECTRIC CO., LTD., its affiliates, subsidiaries and distributors and all their officers and employees, jointly and severally, against any and all claims and litigation and all damages, cost and expenses associated with such use:
 - ② Not impose any responsibility for any fault or negligence which may be cited in any such claim or litigation on SANYO ELECTRIC CO., LTD., its affiliates, subsidiaries and distributors or any of their officers and employees jointly or severally.
- Information (including circuit diagrams and circuit parameters) herein is for example only; it is not guaranteed for volume production. SANYO believes information herein is accurate and reliable, but no guarantees are made or implied regarding its use or any infringements of intellectual property rights or other rights of third parties.

Example application circuit 1:

POWER SW = momentary switch.
ANTI THEFT function used.

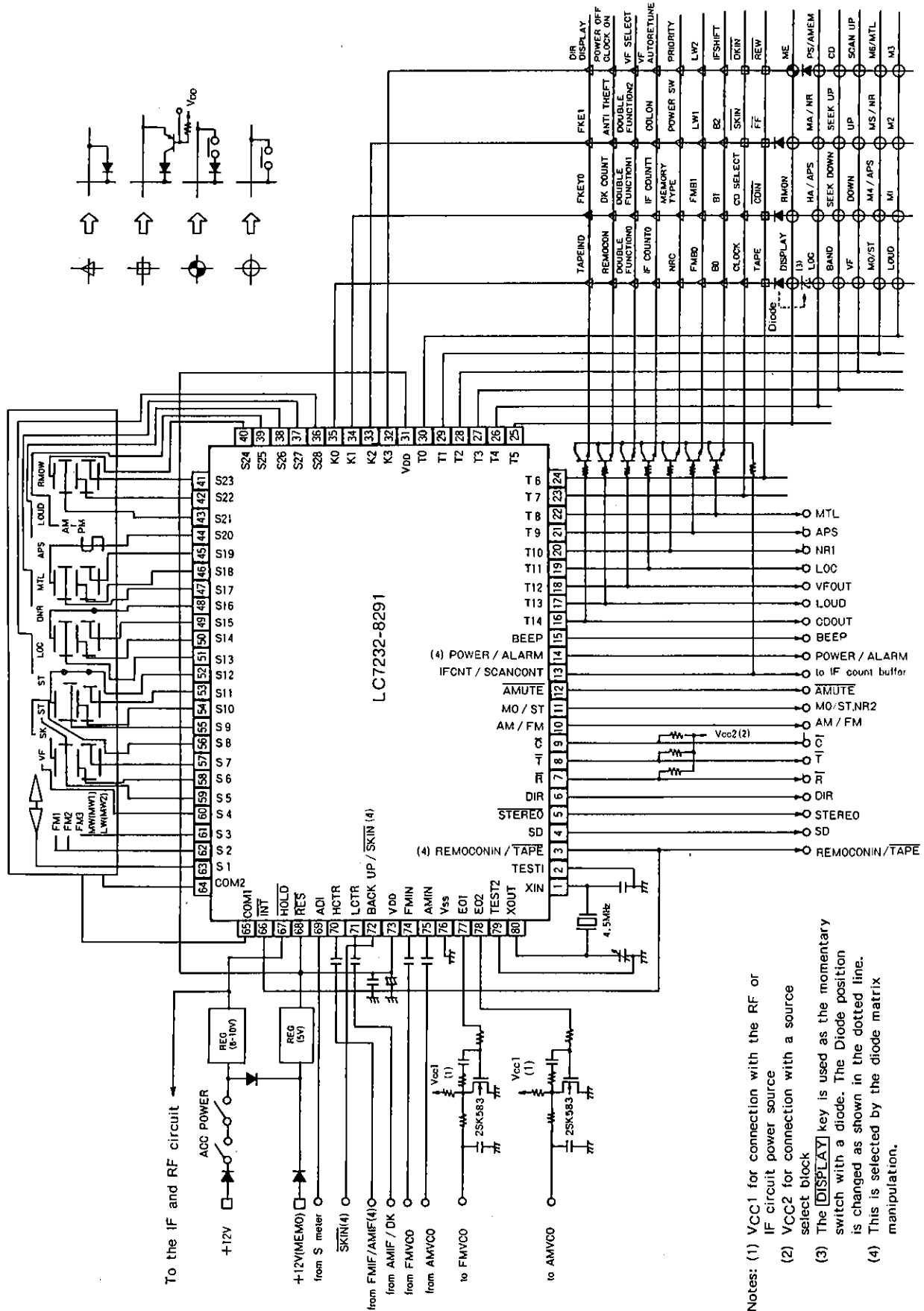

- Notes:
- (1) Vcc1 for connection with the RF or IF circuit power source
 - (2) Vcc2 for connection with a source select block
 - (3) The **DISPLAY** key is used as the momentary switch with a diode. The Diode position is changed as shown in the dotted line.
 - (4) This is selected by the diode matrix manipulation.

