

2N5838, 2N5839, 2N5840

File Number **410**

High-Voltage, High-Power Silicon N-P-N Power Transistors

For Switching and Linear Applications in Military, Industrial, and Commercial Equipment

Features:

- Maximum safe-area-of-operation curves
- Low saturation voltages
- High voltage ratings
 - $V_{CE(sus)} = 375\text{ V [2N5840]}$
 - 300 V [2N5839]
 - 275 V [2N5838]
- High dissipation rating
 - $P_T = 100\text{ W}$

RCA-2N5838, 2N5839 and 2N5840** are epitaxial silicon n-p-n power transistors. These devices employ the popular JEDEC TO-204AA package; they differ mainly in voltage, current-gain, and $V_{CE(sat)}$ ratings.

Featuring high breakdown voltage ratings and low-saturation voltage values, the 2N5838, 2N5839 and 2N5840 are especially suitable for use in inverters, deflection circuits, switching regulators, high-voltage bridged amplifiers, ignition circuits, and other high-voltage switching applications.

** Formerly RCA Dev. types TA7513, TA7530, and TA7420 respectively.

TERMINAL DESIGNATIONS

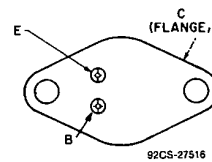

JEDEC TO-204AA

MAXIMUM RATINGS, Absolute-Maximum Values:

	2N5838	2N5839	2N5840	
*COLLECTOR-TO-BASE VOLTAGE, V_{CBO}	275	300	375	V
COLLECTOR-TO-EMITTER SUSTAINING VOLTAGE:				
With base open $V_{CEO(sus)}$	250	275	350	V
* With reverse bias (V_{BE}) of -1.5 V , (V_{CEV}) (sus) *	275	300	375	V
With external base-to-emitter resistance (R_{BE}) $\leq 50\ \Omega$, $V_{CE(sus)}$	275	300	375	V
*EMITTER-TO-BASE VOLTAGE, V_{EBO}	6	6	6	V
*COLLECTOR CURRENT, I_C				
Continuous	3	3	3	A
Peak	5	5	5	A
*CONTINUOUS BASE CURRENT, I_B	1.5	1.5	1.5	A
*TRANSISTOR DISSIPATION, P_T :				
At case temperature up to 25°C and V_{CE} up to 40 V	100	100	100	W
At case temperatures up to 25°C and V_{CE} above 40 V		See Fig. 1.		
At case temperatures up to 25°C and V_{CE} above 40 V		See Figs. 1 & 2.		
*TEMPERATURE RANGE:				
Storage and operating (Junction)		$-65\text{ to }+200$		$^\circ\text{C}$
*PIN TEMPERATURE (During soldering):				
At distances $\geq 1/32\text{ in. (0.8 mm)}$ from case for 10 s max		230		$^\circ\text{C}$
* In accordance with JEDEC registration data format (JS-6, RDF-1).				
• Shown as $V_{CE(sus)}$ in JEDEC Registration Data.				

2N5838, 2N5839, 2N5840

Characteristic	Symbol	Test Conditions							Limits									Units	
		DC Collector Voltage (V _C)		DC Emitter or Base Voltage (V _E)		DC Current (A)			Type 2N5838			Type 2N5839			Type 2N5840				
		V _{CE}	V _{EB}	V _{BE}	I _C	I _B	I _E	Min	Max	Typ	Min	Max	Typ	Min	Max	Typ			
Collector-Cutoff Current: With base open	I _{CEO}	200 250							2				2			2			mA
With base-emitter junction reverse biased	I _{CEV}	265 290 360		-1.5 -1.5 -1.5					5			2				2			mA
With base-emitter junction reverse biased T _C 100 °C	I _{CEV}	265 290 360		1.5 1.5 1.5					8				5				5		mA
Emitter-Cutoff Current	I _{EBO}			-6					1			1				1			mA
Collector-to-Emitter Sustaining Voltage (See Figs. 4, 5, & 6) With base open	V _{CE0} (sus) ^a				0.2				250 ^b			275 ^b				350 ^b			V
With base-emitter junction reversed biased	V _{CEx} (sus) ^a			1.5	0.1				275 ^b			300 ^b				375 ^b			V
With external base-to-emitter resistance (R _{BE}) = 50 Ω	V _{CER} (sus) ^a				0.2				275 ^b			300 ^b				375 ^b			V
Emitter-to-Base Voltage	V _{EBO}						0.02	6			6			6					V
DC Forward-Current Transfer Ratio	h _{FE}	5 3 2			0.5 ^b 2 ^b 3 ^b			20 - 8			20 10 -		20 50 -		20 10 -		50 -		
Base-to-Emitter Saturation Voltage	V _{BE} (sat)				2 3	0.2 0.375 ^e			2			2			2				V
Collector-to-Emitter Saturation Voltage	V _{CE} (sat)				2 3	0.2 0.375 ^e			1			1.5			1.5				V
Output Capacitance (At 1 MHz)	C _{obo}		10d					0	150			150			150				pF
Magnitude of Common-Emitter, Small-Signal, Short Circuit, Forward Current Transfer Ratio (f = 1 MHz)	h _{fe}	10			0.2				5			5			5				
Second Breakdown Collector Current (With base forward biased) Pulse duration (non-repetitive) 1 s	I _S /I _C	40							2.5			2.5			2.5				A
Switching Times: Delay	t _d	V _{CC} - 200			2 3	0.2 ^e 0.375 ^e								0.07				0.07	
Rise	t _r	V _{CC} - 200			2 3	0.2 ^e 0.375 ^e				1.5 0.8		1.5	0.6		1.75	0.6			
Storage	t _s	V _{CC} - 200			2 3	0.2 ^e 0.375 ^e					3.0 1.0	3.75	1.75		3.0	1.75			
Fall	t _f	V _{CC} - 200			2 3	0.2 ^e 0.375 ^e						1.5	0.35		1.5	0.35			
Thermal Resistance (Junction-to-Case)	θ _{J-C}	10			5				1.75			1.75			1.75				°C/W

^a Pulsed; pulse duration ≤ 350 μs, Duty factor = 2%.

^b CAUTION: The sustaining voltages V_{CE0}(sus), V_{CEx}(sus) and V_{CER}(sus), MUST NOT be measured on a curve tracer.

^c I_S/I_C is defined as the current at which second breakdown occurs at a specified collector voltage with the emitter-base junction forward biased for transistor operation in the active region.

^d V_{CB}

^e I_{B1} = I_{B2} = value shown.

* In accordance with JEDEC registration data format (JS-6 RDF-1).

2N5838, 2N5839, 2N5840

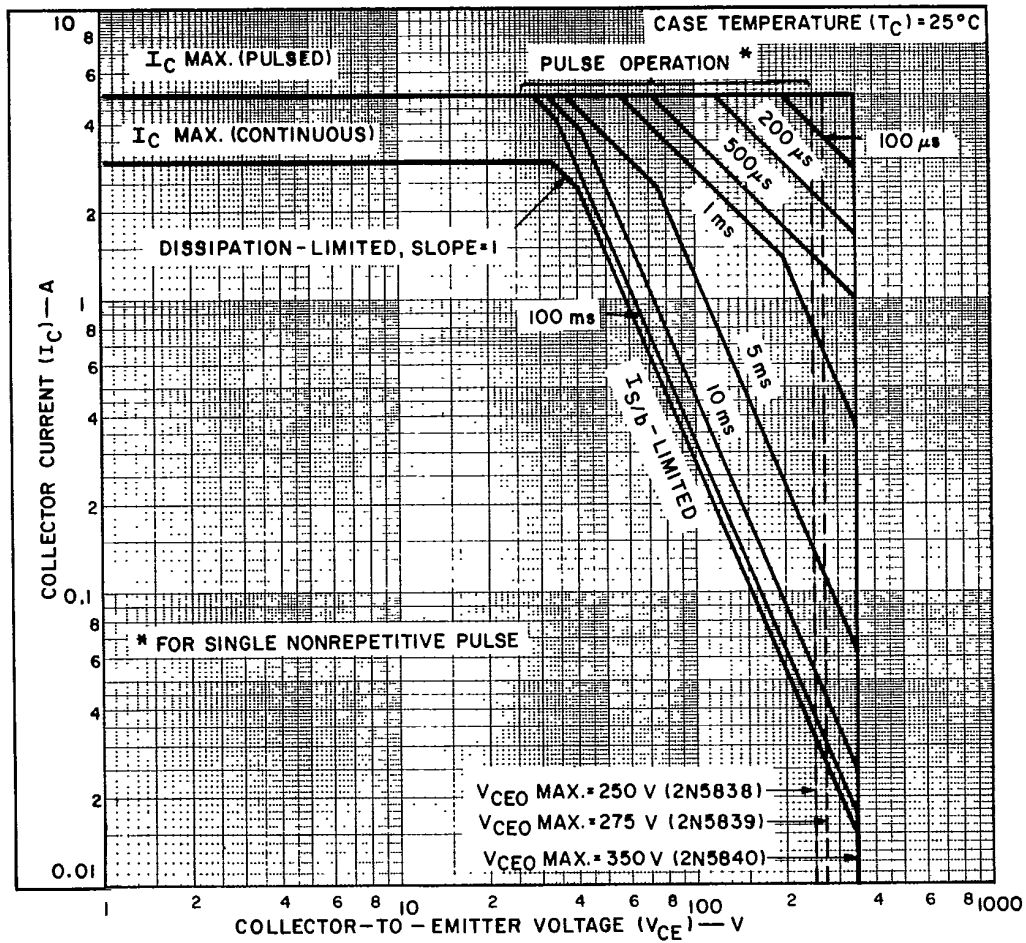

Fig. 1 — Maximum operating areas for all types.

92CS-15905

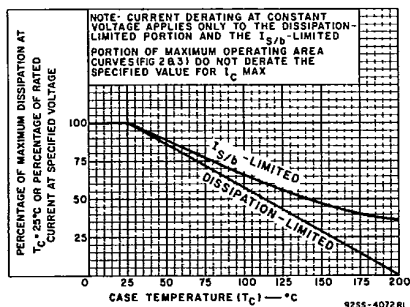

Fig. 2 — Derating curves for all types.

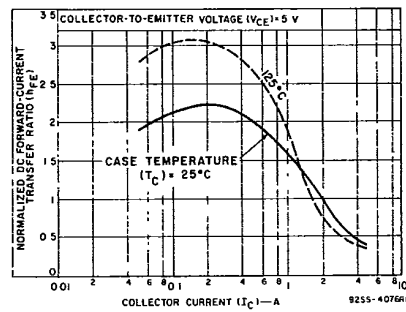
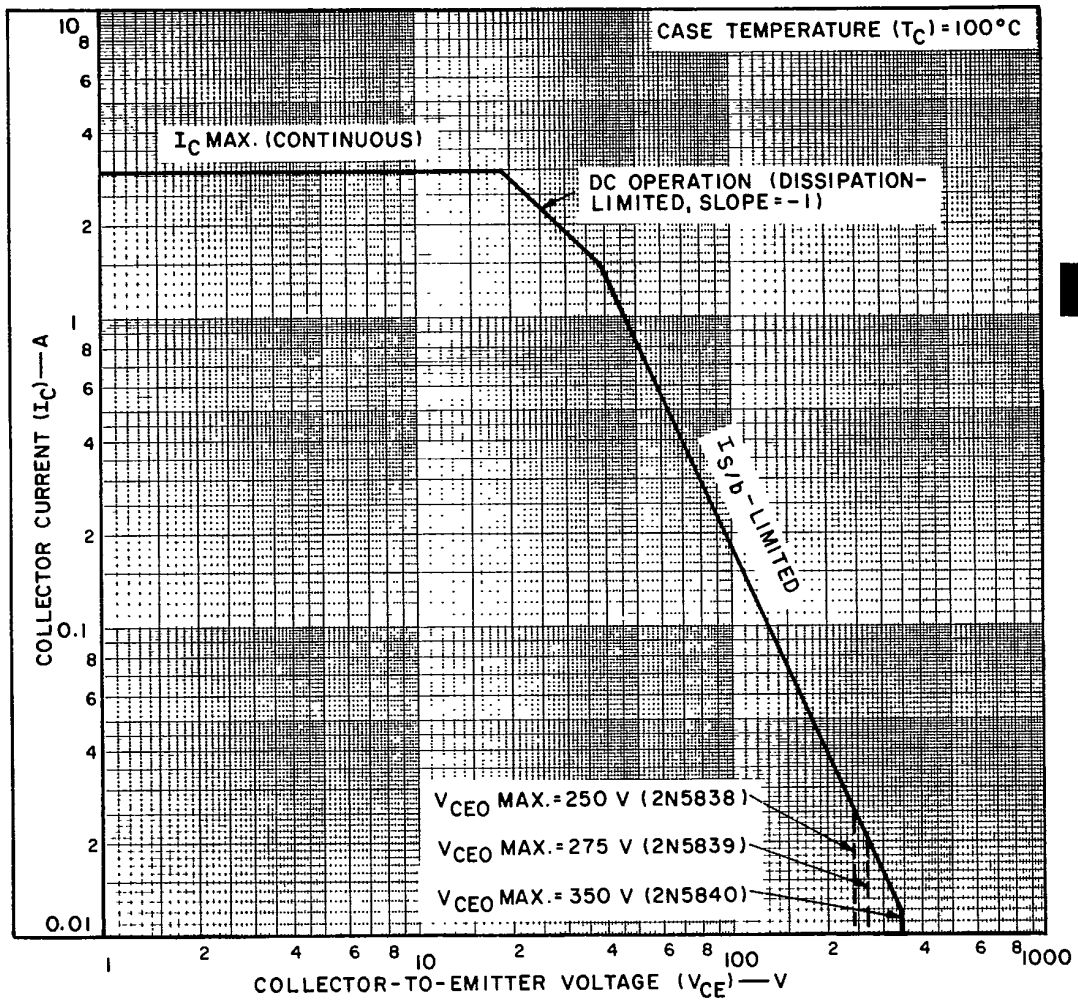

Fig. 3 — Typical normalized dc beta characteristics for all types.

2N5838, 2N5839, 2N5840



92CS-15906

Fig. 4 — Maximum operating areas for all types.

2N5838, 2N5839, 2N5840

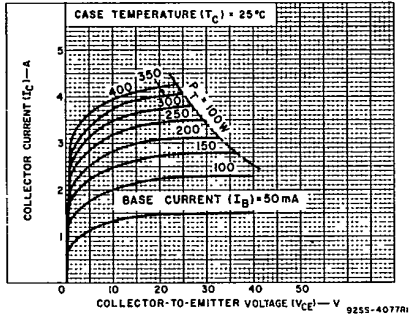

Fig. 5 — Typical output characteristics for all types.

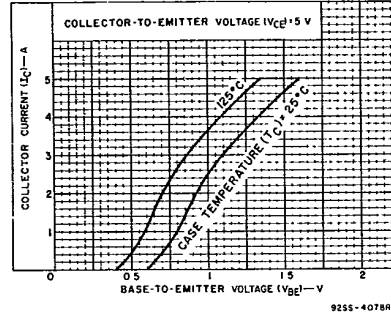

Fig. 6 — Typical transfer characteristics for all types.

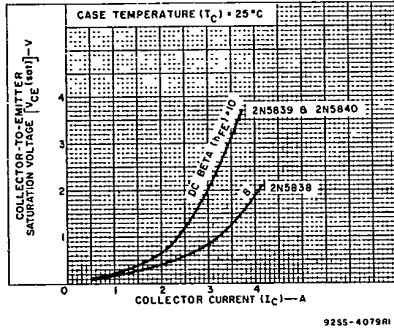

Fig. 7 — Typical saturation voltage characteristics for all types.

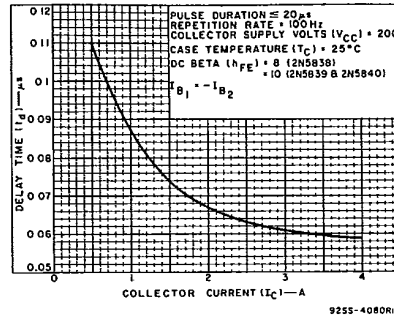

Fig. 8 — Typical delay-time characteristics for all types.

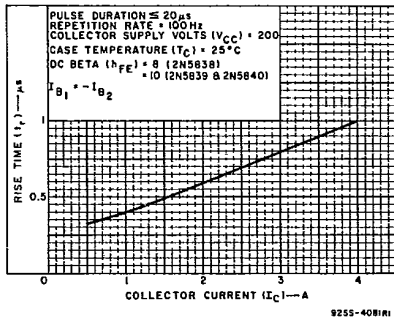

Fig. 9 — Typical rise-time characteristics for all types.

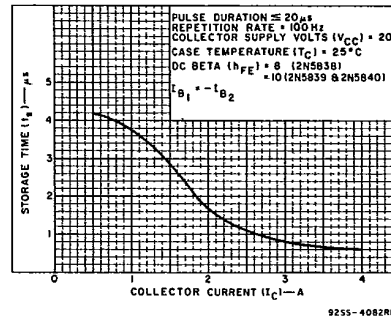

Fig. 10 — Typical storage-time characteristics for all types.

2N5838, 2N5839, 2N5840

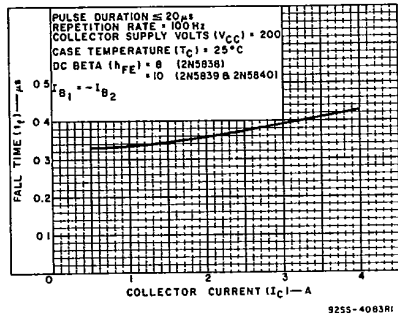

Fig. 11 — Typical fall-time characteristics for all types.

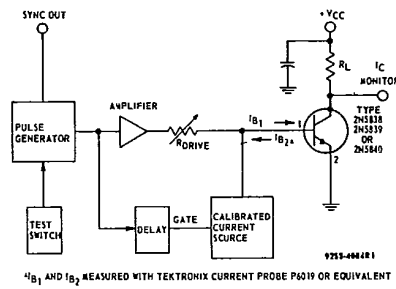

Fig. 12 — Circuit used to measure switching times for all types.

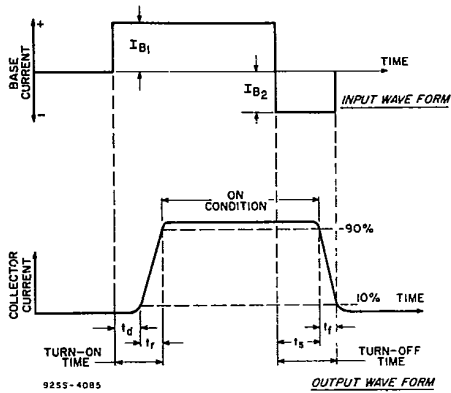

Fig. 13 — Phase relationship between input and output currents showing reference points for specification of switching times.

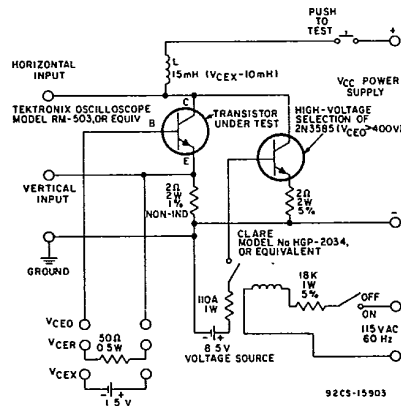
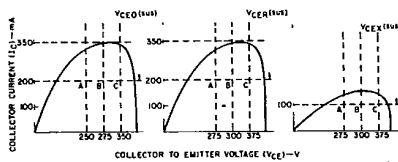

Fig. 14 — Circuit used to measure sustaining voltages $V_{CE0}(sus)$, $V_{CEr}(sus)$, and $V_{CEX}(sus)$ for all types.



The sustaining voltages $V_{CE0}(sus)$, $V_{CEr}(sus)$, and $V_{CEX}(sus)$ are acceptable when the traces fall to the right and above point "A" for type 2N5838, point "B" for type 2N5839, and point "C" for type 2N5840.

Fig. 15 — Oscilloscope display for measurement of sustaining voltages.