

BC846BPDW1T1, BC847BPDW1T1, BC847CPDW1T1, BC848BPDW1T1, BC848CPDW1T1



ON Semiconductor
Formerly a Division of Motorola
<http://onsemi.com>

Dual General Purpose Transistors

NPN/PNP Duals

These transistors are designed for general purpose amplifier applications. They are housed in the SOT-363/SC-88 which is designed for low power surface mount applications.

- Device Marking:
BC846BPDW1T1 = BB
BC847BPDW1T1 = 13F
BC847CPDW1T1 = 13G
BC848BPDW1T1 = 13K
BC848CPDW1T1 = 13L

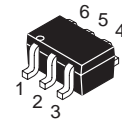
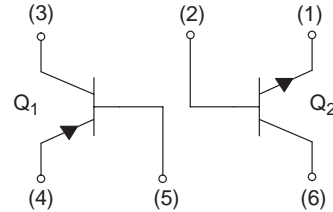

SOT-363/SC-88
CASE 419B
STYLE 1

MAXIMUM RATINGS – NPN

Rating	Symbol	BC846	BC847	BC848	Unit
Collector–Emitter Voltage	V_{CEO}	65	45	30	V
Collector–Base Voltage	V_{CBO}	80	50	30	V
Emitter–Base Voltage	V_{EBO}	6.0	6.0	5.0	V
Collector Current — Continuous	I_C	100	100	100	mAdc

MAXIMUM RATINGS – PNP

Rating	Symbol	BC846	BC847	BC848	Unit
Collector–Emitter Voltage	V_{CEO}	–65	–45	–30	V
Collector–Base Voltage	V_{CBO}	–80	–50	–30	V
Emitter–Base Voltage	V_{EBO}	–5.0	–5.0	–5.0	V
Collector Current — Continuous	I_C	–100	–100	–100	mAdc

THERMAL CHARACTERISTICS

Characteristic	Symbol	Max	Unit
Total Device Dissipation Per Device FR-5 Board (1) $T_A = 25^\circ\text{C}$ Derate Above 25°C	P_D	380 250 3.0	mW mW/°C
Thermal Resistance, Junction to Ambient	$R_{\theta JA}$	328	°C/W
Junction and Storage Temperature Range	T_J, T_{stg}	–55 to +150	°C

1. FR-5 = 1.0 x 0.75 x 0.062 in

DEVICE MARKING

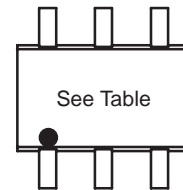

ORDERING INFORMATION

Device	Package	Shipping
BC846BPDW1T1	SOT-363	3000 Units/Reel
BC847BPDW1T1	SOT-363	3000 Units/Reel
BC847CPDW1T1	SOT-363	3000 Units/Reel
BC848BPDW1T1	SOT-363	3000 Units/Reel
BC848CPDW1T1	SOT-363	3000 Units/Reel

BC846BPDW1T1, BC847BPDW1T1, BC847CPDW1T1, BC848BPDW1T1, BC848CPDW1T1

ELECTRICAL CHARACTERISTICS (NPN) ($T_A = 25^\circ\text{C}$ unless otherwise noted)

Characteristic	Symbol	Min	Typ	Max	Unit	
OFF CHARACTERISTICS						
Collector–Emitter Breakdown Voltage ($I_C = 10\text{ mA}$)	BC846 Series BC847 Series BC848 Series	$V_{(BR)CEO}$	65 45 30	— — —	— — —	V
Collector–Emitter Breakdown Voltage ($I_C = 10\ \mu\text{A}$, $V_{EB} = 0$)	BC846 Series BC847 Series BC848 Series	$V_{(BR)CES}$	80 50 30	— — —	— — —	V
Collector–Base Breakdown Voltage ($I_C = 10\ \mu\text{A}$)	BC846 Series BC847 Series BC848 Series	$V_{(BR)CBO}$	80 50 30	— — —	— — —	V
Emitter–Base Breakdown Voltage ($I_E = 1.0\ \mu\text{A}$)	BC846 Series BC847 Series BC848 Series	$V_{(BR)EBO}$	6.0 6.0 5.0	— — —	— — —	V
Collector Cutoff Current ($V_{CB} = 30\text{ V}$) ($V_{CB} = 30\text{ V}$, $T_A = 150^\circ\text{C}$)		I_{CBO}	— —	— —	15 5.0	nA μA

ON CHARACTERISTICS

DC Current Gain ($I_C = 10\ \mu\text{A}$, $V_{CE} = 5.0\text{ V}$)	BC846B, BC847B, BC848B BC847C, BC848C	h_{FE}	— —	150 270	— —	—
($I_C = 2.0\text{ mA}$, $V_{CE} = 5.0\text{ V}$)	BC846B, BC847B, BC848B BC847C, BC848C		200 420	290 520	475 800	
Collector–Emitter Saturation Voltage ($I_C = 10\text{ mA}$, $I_B = 0.5\text{ mA}$) ($I_C = 100\text{ mA}$, $I_B = 5.0\text{ mA}$)		$V_{CE(sat)}$	— —	— —	0.25 0.6	V
Base–Emitter Saturation Voltage ($I_C = 10\text{ mA}$, $I_B = 0.5\text{ mA}$) ($I_C = 100\text{ mA}$, $I_B = 5.0\text{ mA}$)		$V_{BE(sat)}$	— —	0.7 0.9	— —	V
Base–Emitter Voltage ($I_C = 2.0\text{ mA}$, $V_{CE} = 5.0\text{ V}$) ($I_C = 10\text{ mA}$, $V_{CE} = 5.0\text{ V}$)		$V_{BE(on)}$	580 —	660 —	700 770	mV

SMALL–SIGNAL CHARACTERISTICS

Current–Gain — Bandwidth Product ($I_C = 10\text{ mA}$, $V_{CE} = 5.0\text{ Vdc}$, $f = 100\text{ MHz}$)		f_T	100	—	—	MHz
Output Capacitance ($V_{CB} = 10\text{ V}$, $f = 1.0\text{ MHz}$)		C_{obo}	—	—	4.5	pF
Noise Figure ($I_C = 0.2\text{ mA}$, $V_{CE} = 5.0\text{ Vdc}$, $R_S = 2.0\text{ k}\Omega$, $f = 1.0\text{ kHz}$, $BW = 200\text{ Hz}$)	BC846B, BC847B, BC848B BC847C, BC848C	NF	— —	— —	10 4.0	dB

BC846BPDW1T1, BC847BPDW1T1, BC847CPDW1T1, BC848BPDW1T1, BC848CPDW1T1

ELECTRICAL CHARACTERISTICS (PNP) ($T_A = 25^\circ\text{C}$ unless otherwise noted)

Characteristic	Symbol	Min	Typ	Max	Unit
OFF CHARACTERISTICS					
Collector–Emitter Breakdown Voltage ($I_C = -10\text{ mA}$)	BC846 Series BC847 Series BC848 Series $V_{(BR)CEO}$	-65 -45 -30	— — —	— — —	V
Collector–Emitter Breakdown Voltage ($I_C = -10\ \mu\text{A}$, $V_{EB} = 0$)	BC846 Series BC847 Series BC848 Series $V_{(BR)CES}$	-80 -50 -30	— — —	— — —	V
Collector–Base Breakdown Voltage ($I_C = -10\ \mu\text{A}$)	BC846 Series BC847 Series BC848 Series $V_{(BR)CBO}$	-80 -50 -30	— — —	— — —	V
Emitter–Base Breakdown Voltage ($I_E = -1.0\ \mu\text{A}$)	BC846 Series BC847 Series BC848 Series $V_{(BR)EBO}$	-5.0 -5.0 -5.0	— — —	— — —	V
Collector Cutoff Current ($V_{CB} = -30\text{ V}$) ($V_{CB} = -30\text{ V}$, $T_A = 150^\circ\text{C}$)	I_{CBO}	— —	— —	-15 -4.0	nA μA
ON CHARACTERISTICS					
DC Current Gain ($I_C = -10\ \mu\text{A}$, $V_{CE} = -5.0\text{ V}$)	BC846B, BC847B, BC848B BC847C, BC848C h_{FE}	— —	150 270	— —	—
($I_C = -2.0\text{ mA}$, $V_{CE} = -5.0\text{ V}$)	BC846B, BC847B, BC848B BC847C, BC848C	200 420	290 520	475 800	
Collector–Emitter Saturation Voltage ($I_C = -10\text{ mA}$, $I_B = -0.5\text{ mA}$) ($I_C = -100\text{ mA}$, $I_B = -5.0\text{ mA}$)	$V_{CE(sat)}$	— —	— —	-0.3 -0.65	V
Base–Emitter Saturation Voltage ($I_C = -10\text{ mA}$, $I_B = -0.5\text{ mA}$) ($I_C = -100\text{ mA}$, $I_B = -5.0\text{ mA}$)	$V_{BE(sat)}$	— —	-0.7 -0.9	— —	V
Base–Emitter On Voltage ($I_C = -2.0\text{ mA}$, $V_{CE} = -5.0\text{ V}$) ($I_C = -10\text{ mA}$, $V_{CE} = -5.0\text{ V}$)	$V_{BE(on)}$	-0.6 —	— —	-0.75 -0.82	V
SMALL–SIGNAL CHARACTERISTICS					
Current–Gain — Bandwidth Product ($I_C = -10\text{ mA}$, $V_{CE} = -5.0\text{ Vdc}$, $f = 100\text{ MHz}$)	f_T	100	—	—	MHz
Output Capacitance ($V_{CB} = -10\text{ V}$, $f = 1.0\text{ MHz}$)	C_{ob}	—	—	4.5	pF
Noise Figure ($I_C = -0.2\text{ mA}$, $V_{CE} = -5.0\text{ Vdc}$, $R_S = 2.0\text{ k}\Omega$, $f = 1.0\text{ kHz}$, $BW = 200\text{ Hz}$)	NF	—	—	10	dB

**BC846BPDW1T1, BC847BPDW1T1, BC847CPDW1T1, BC848BPDW1T1,
BC848CPDW1T1**

TYPICAL NPN CHARACTERISTICS

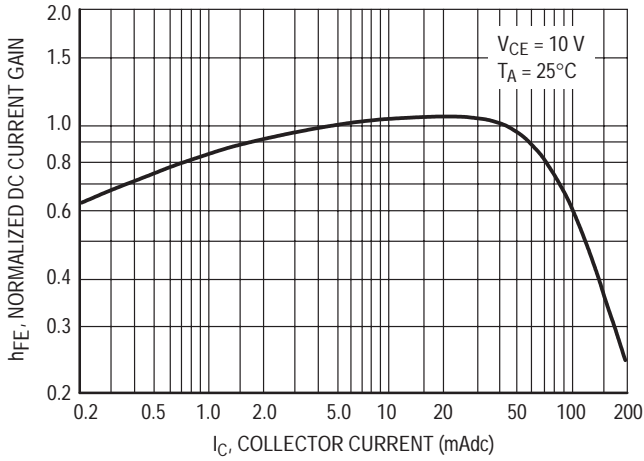

Figure 1. Normalized DC Current Gain

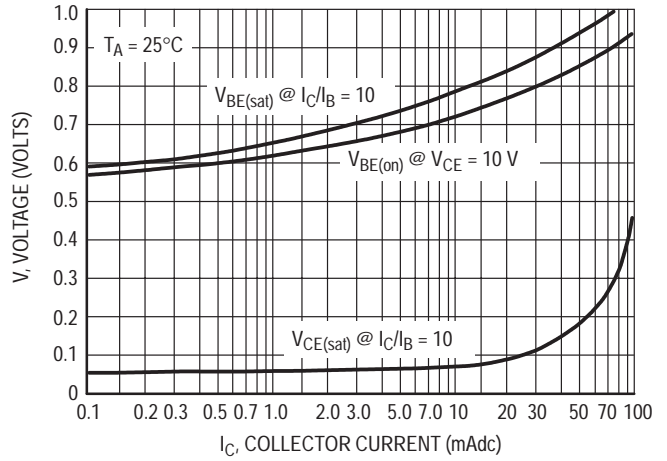

Figure 2. "Saturation" and "On" Voltages

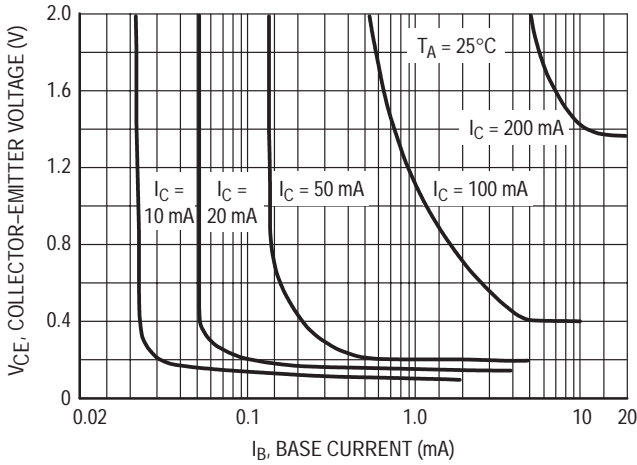

Figure 3. Collector Saturation Region

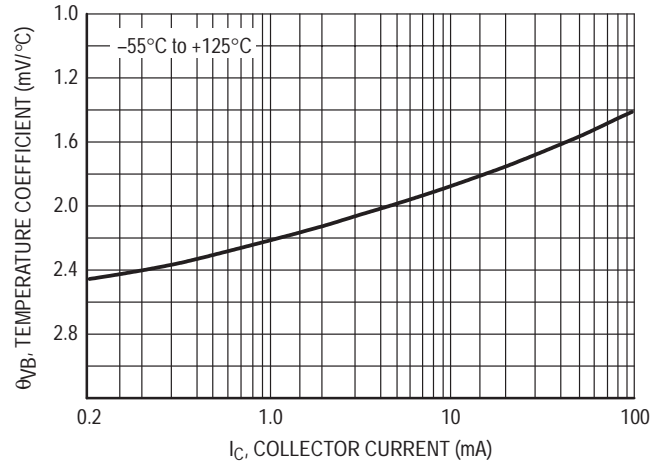

Figure 4. Base-Emitter Temperature Coefficient

**BC846BPDW1T1, BC847BPDW1T1, BC847CPDW1T1, BC848BPDW1T1,
BC848CPDW1T1**

TYPICAL NPN CHARACTERISTICS

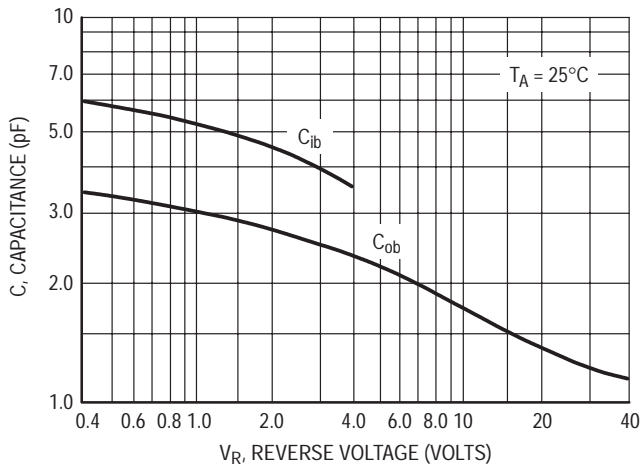

Figure 5. Capacitances

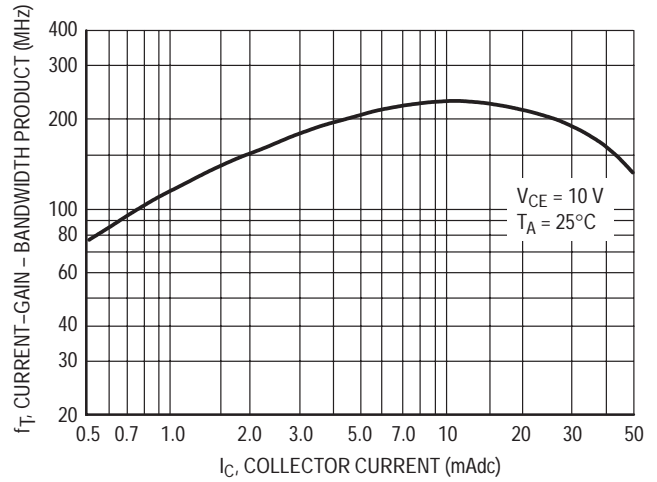

Figure 6. Current-Gain - Bandwidth Product

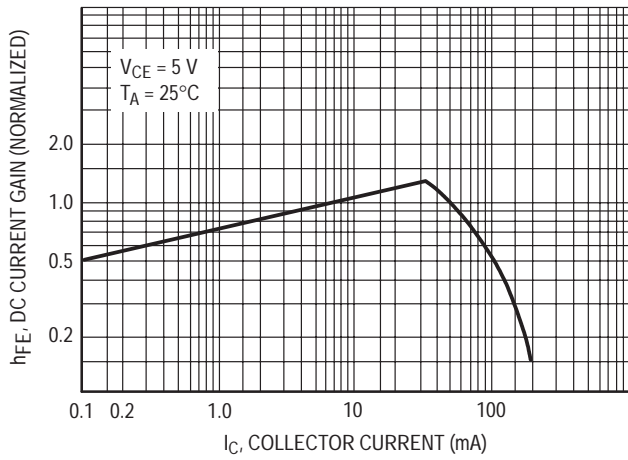

Figure 7. DC Current Gain

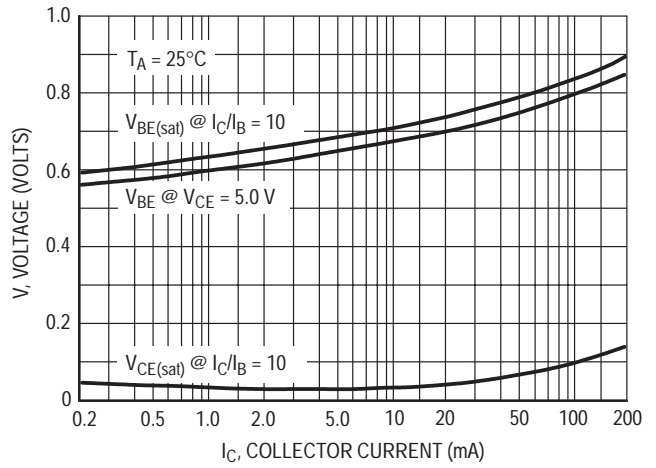

Figure 8. "On" Voltage

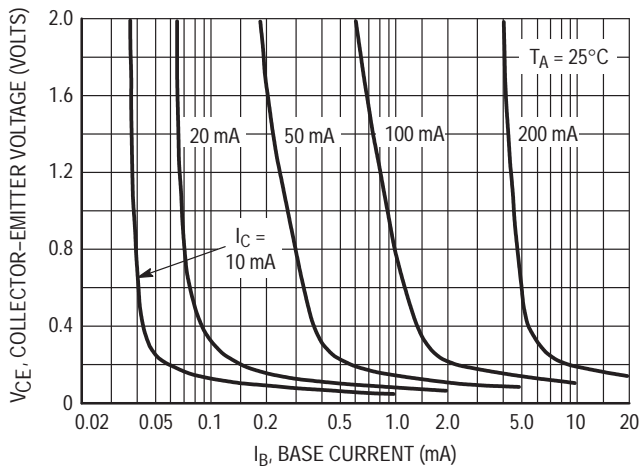

Figure 9. Collector Saturation Region

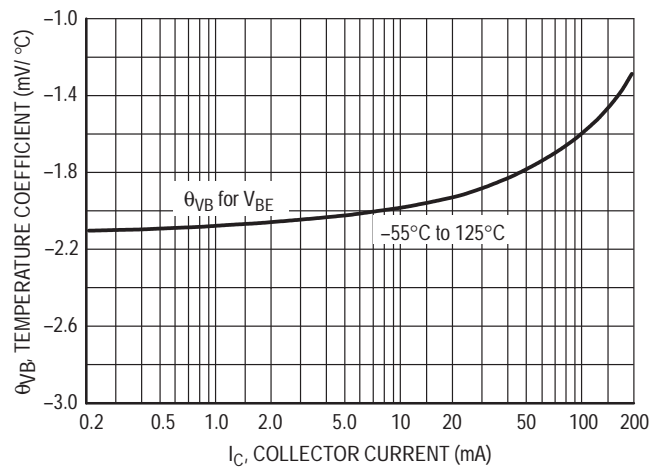

Figure 10. Base-Emitter Temperature Coefficient

BC846BPDW1T1, BC847BPDW1T1, BC847CPDW1T1, BC848BPDW1T1,
BC848CPDW1T1

TYPICAL PNP CHARACTERISTICS — BC846

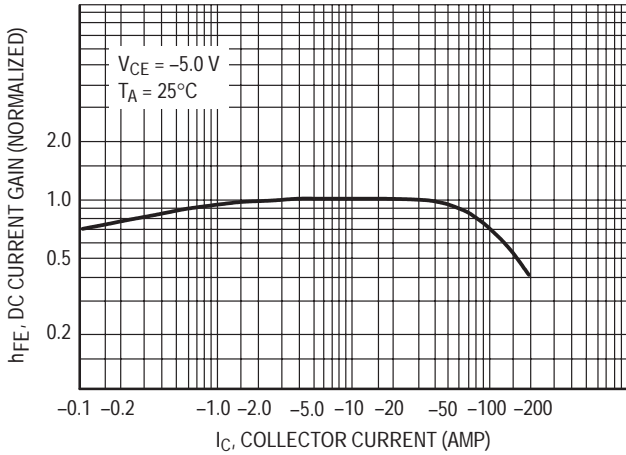

Figure 11. DC Current Gain

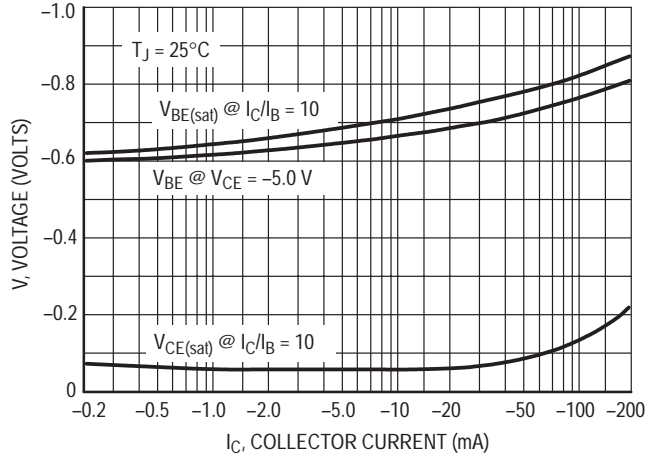

Figure 12. "On" Voltage

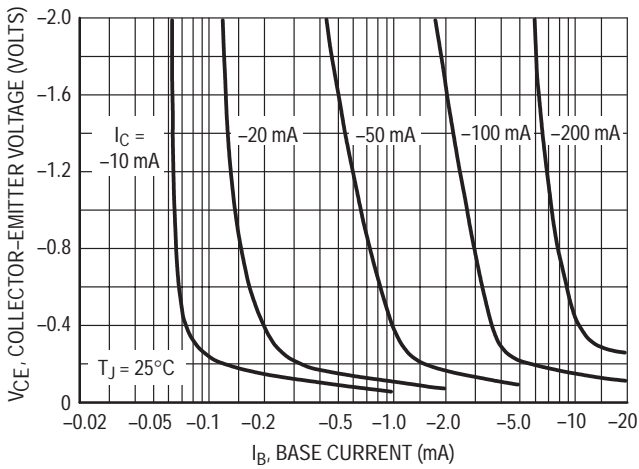

Figure 13. Collector Saturation Region

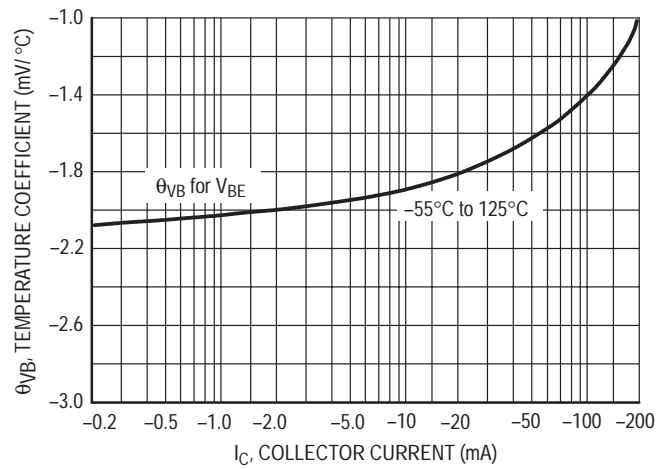

Figure 14. Base-Emitter Temperature Coefficient

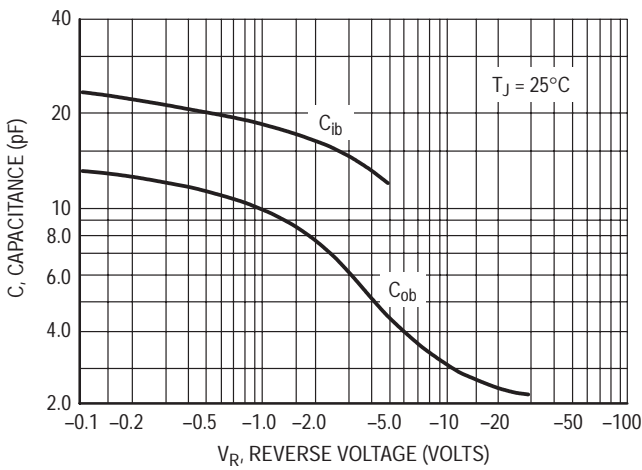

Figure 15. Capacitance

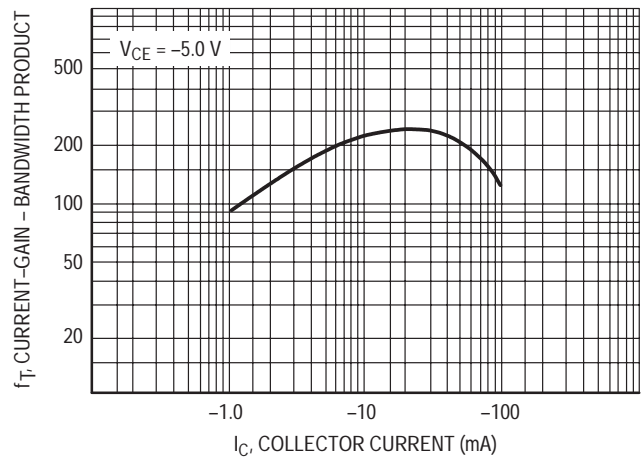

Figure 16. Current-Gain - Bandwidth Product

**BC846BPDW1T1, BC847BPDW1T1, BC847CPDW1T1, BC848BPDW1T1,
BC848CPDW1T1**

TYPICAL PNP CHARACTERISTICS — BC847/BC848

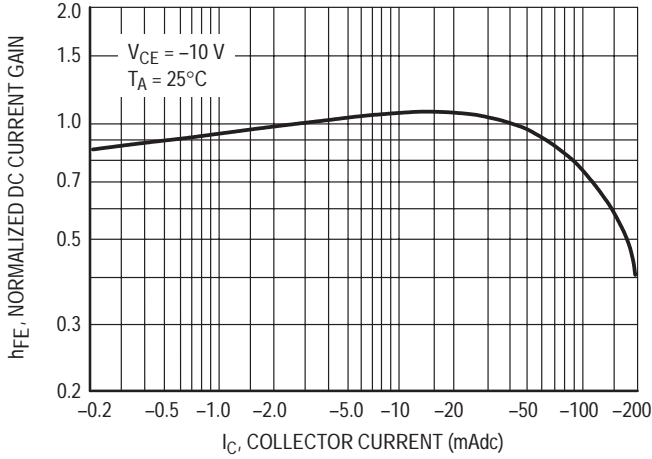

Figure 17. Normalized DC Current Gain

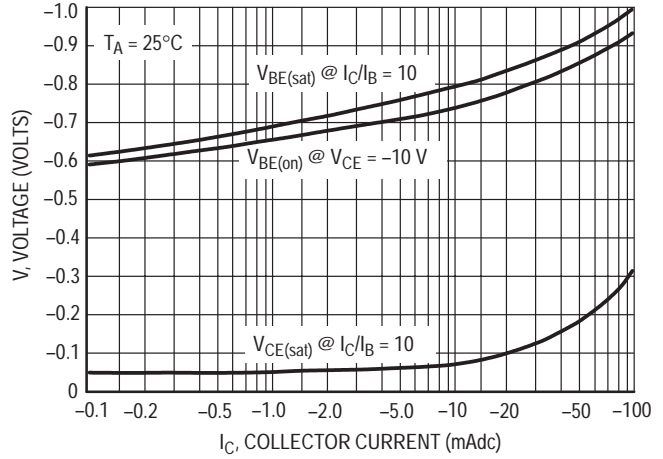

Figure 18. "Saturation" and "On" Voltages

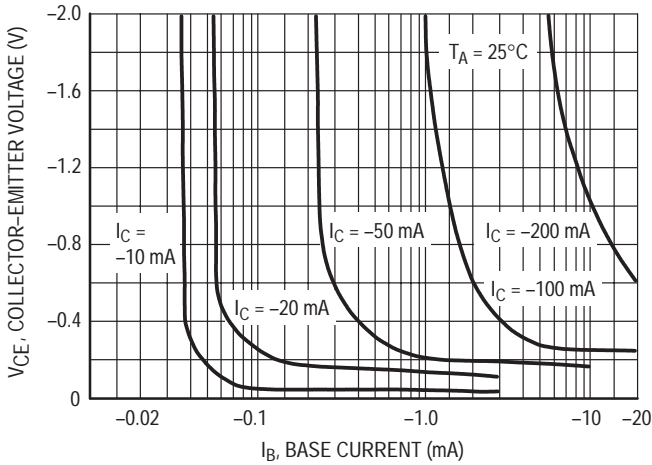

Figure 19. Collector Saturation Region

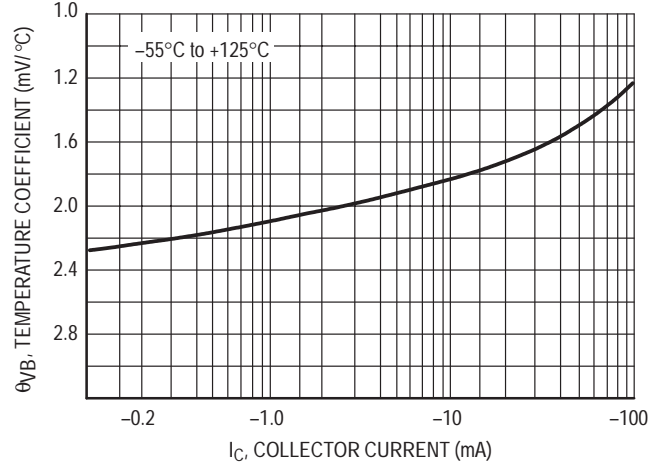

Figure 20. Base-Emitter Temperature Coefficient

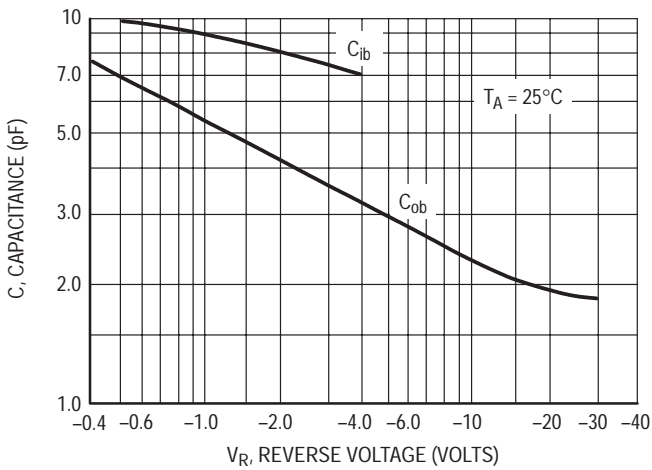

Figure 21. Capacitances

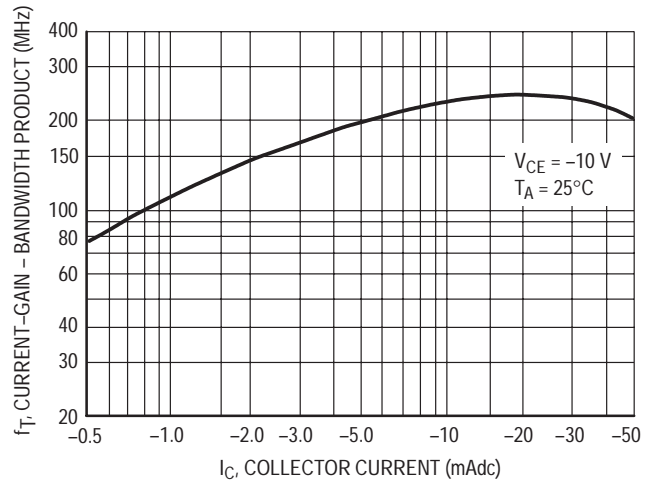

Figure 22. Current-Gain - Bandwidth Product

**BC846BPDW1T1, BC847BPDW1T1, BC847CPDW1T1, BC848BPDW1T1,
BC848CPDW1T1**

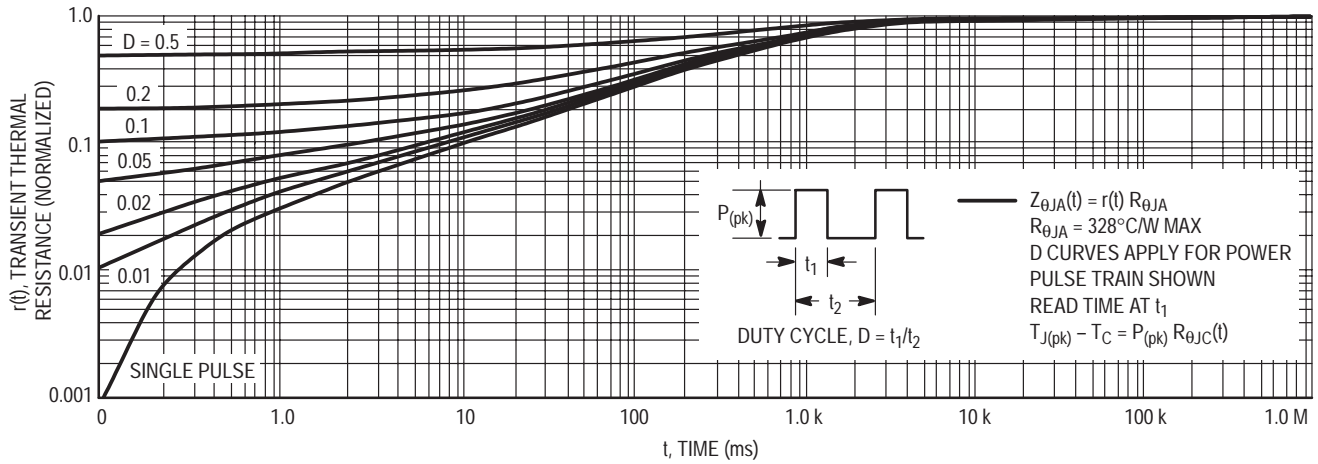

Figure 23. Thermal Response

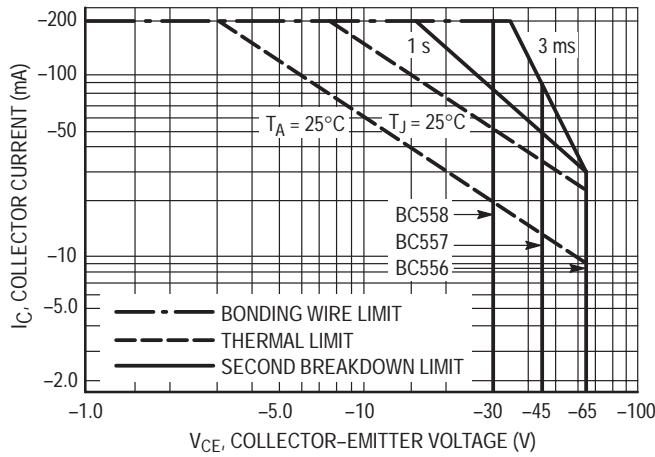

Figure 24. Active Region Safe Operating Area

The safe operating area curves indicate I_C - V_{CE} limits of the transistor that must be observed for reliable operation. Collector load lines for specific circuits must fall below the limits indicated by the applicable curve.

The data of Figure 14 is based upon $T_{J(pk)} = 150^\circ\text{C}$; T_C or T_A is variable depending upon conditions. Pulse curves are valid for duty cycles to 10% provided $T_{J(pk)} \leq 150^\circ\text{C}$. $T_{J(pk)}$ may be calculated from the data in Figure 13. At high case or ambient temperatures, thermal limitations will reduce the power that can be handled to values less than the limitations imposed by the secondary breakdown.

BC846BPDW1T1, BC847BPDW1T1, BC847CPDW1T1, BC848BPDW1T1, BC848CPDW1T1

INFORMATION FOR USING THE SOT-363 SURFACE MOUNT PACKAGE

MINIMUM RECOMMENDED FOOTPRINT FOR SURFACE MOUNTED APPLICATIONS

Surface mount board layout is a critical portion of the total design. The footprint for the semiconductor packages must be the correct size to insure proper solder connection

interface between the board and the package. With the correct pad geometry, the packages will self align when subjected to a solder reflow process.

SOT-363

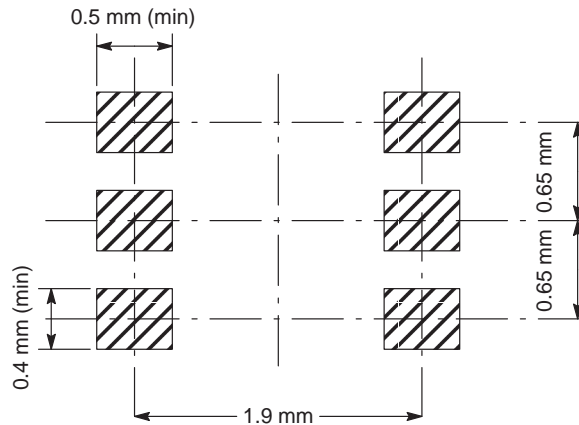

SOT-363 POWER DISSIPATION

The power dissipation of the SOT-363 is a function of the pad size. This can vary from the minimum pad size for soldering to a pad size given for maximum power dissipation. Power dissipation for a surface mount device is determined by $T_{J(max)}$, the maximum rated junction temperature of the die, $R_{\theta JA}$, the thermal resistance from the device junction to ambient, and the operating temperature, T_A . Using the values provided on the data sheet for the SOT-363 package, P_D can be calculated as follows:

$$P_D = \frac{T_{J(max)} - T_A}{R_{\theta JA}}$$

The values for the equation are found in the maximum ratings table on the data sheet. Substituting these values into the equation for an ambient temperature T_A of 25°C, one can calculate the power dissipation of the device which in this case is 150 milliwatts.

$$P_D = \frac{150^\circ\text{C} - 25^\circ\text{C}}{833^\circ\text{C/W}} = 150 \text{ milliwatts}$$

The 833°C/W for the SOT-363 package assumes the use of the recommended footprint on a glass epoxy printed circuit board to achieve a power dissipation of 150 milliwatts. There are other alternatives to achieving higher power dissipation from the SOT-363 package. Another alternative would be to use a ceramic substrate or an aluminum core board such as Thermal Clad™. Using a board material such as Thermal Clad, an aluminum core board, the power dissipation can be doubled using the same footprint.

SOLDERING PRECAUTIONS

The melting temperature of solder is higher than the rated temperature of the device. When the entire device is heated to a high temperature, failure to complete soldering within a short time could result in device failure. Therefore, the following items should always be observed in order to minimize the thermal stress to which the devices are subjected.

- Always preheat the device.
- The delta temperature between the preheat and soldering should be 100°C or less.*
- When preheating and soldering, the temperature of the leads and the case must not exceed the maximum temperature ratings as shown on the data sheet. When using infrared heating with the reflow soldering method, the difference shall be a maximum of 10°C.
- The soldering temperature and time shall not exceed 260°C for more than 10 seconds.
- When shifting from preheating to soldering, the maximum temperature gradient shall be 5°C or less.
- After soldering has been completed, the device should be allowed to cool naturally for at least three minutes. Gradual cooling should be used as the use of forced cooling will increase the temperature gradient and result in latent failure due to mechanical stress.
- Mechanical stress or shock should not be applied during cooling.

* Soldering a device without preheating can cause excessive thermal shock and stress which can result in damage to the device.

Notes

BC846BPDW1T1, BC847BPDW1T1, BC847CPDW1T1, BC848BPDW1T1,
BC848CPDW1T1

PACKAGE DIMENSIONS

SOT-363/SC-88
CASE 419B-01
ISSUE G

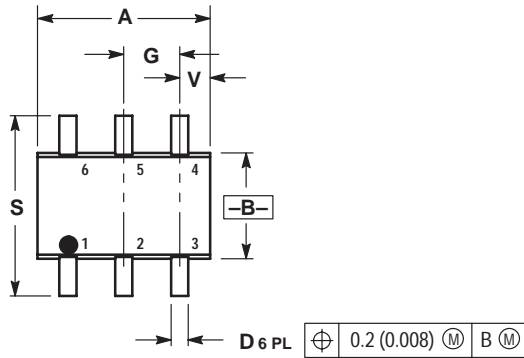

- NOTES:
1. DIMENSIONING AND TOLERANCING PER ANSI Y14.5M, 1982.
2. CONTROLLING DIMENSION: INCH.

DIM	INCHES		MILLIMETERS	
	MIN	MAX	MIN	MAX
A	0.071	0.087	1.80	2.20
B	0.045	0.053	1.15	1.35
C	0.031	0.043	0.80	1.10
D	0.004	0.012	0.10	0.30
G	0.026 BSC		0.65 BSC	
H	---	0.004	---	0.10
J	0.004	0.010	0.10	0.25
K	0.004	0.012	0.10	0.30
N	0.008 REF		0.20 REF	
S	0.079	0.087	2.00	2.20
V	0.012	0.016	0.30	0.40

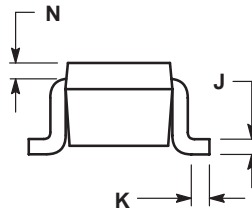
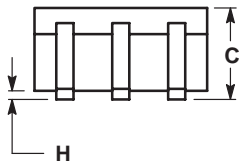

- STYLE 1:
PIN 1. EMITTER 2
2. BASE 2
3. COLLECTOR 1
4. EMITTER 1
5. BASE 1
6. COLLECTOR 2

**BC846BPDW1T1, BC847BPDW1T1, BC847CPDW1T1, BC848BPDW1T1,
BC848CPDW1T1**

Thermal Clad is a trademark of the Bergquist Company.

ON Semiconductor and  are trademarks of Semiconductor Components Industries, LLC (SCILLC). SCILLC reserves the right to make changes without further notice to any products herein. SCILLC makes no warranty, representation or guarantee regarding the suitability of its products for any particular purpose, nor does SCILLC assume any liability arising out of the application or use of any product or circuit, and specifically disclaims any and all liability, including without limitation special, consequential or incidental damages. "Typical" parameters which may be provided in SCILLC data sheets and/or specifications can and do vary in different applications and actual performance may vary over time. All operating parameters, including "Typicals" must be validated for each customer application by customer's technical experts. SCILLC does not convey any license under its patent rights nor the rights of others. SCILLC products are not designed, intended, or authorized for use as components in systems intended for surgical implant into the body, or other applications intended to support or sustain life, or for any other application in which the failure of the SCILLC product could create a situation where personal injury or death may occur. Should Buyer purchase or use SCILLC products for any such unintended or unauthorized application, Buyer shall indemnify and hold SCILLC and its officers, employees, subsidiaries, affiliates, and distributors harmless against all claims, costs, damages, and expenses, and reasonable attorney fees arising out of, directly or indirectly, any claim of personal injury or death associated with such unintended or unauthorized use, even if such claim alleges that SCILLC was negligent regarding the design or manufacture of the part. SCILLC is an Equal Opportunity/Affirmative Action Employer.

PUBLICATION ORDERING INFORMATION

North America Literature Fulfillment:

Literature Distribution Center for ON Semiconductor
P.O. Box 5163, Denver, Colorado 80217 USA
Phone: 303-675-2175 or 800-344-3860 Toll Free USA/Canada
Fax: 303-675-2176 or 800-344-3867 Toll Free USA/Canada
Email: ONlit@hibbertco.com

N. American Technical Support: 800-282-9855 Toll Free USA/Canada

EUROPE: LDC for ON Semiconductor – European Support

German Phone: (+1) 303-308-7140 (M-F 2:30pm to 5:00pm Munich Time)
Email: ONlit-german@hibbertco.com
French Phone: (+1) 303-308-7141 (M-F 2:30pm to 5:00pm Toulouse Time)
Email: ONlit-french@hibbertco.com
English Phone: (+1) 303-308-7142 (M-F 1:30pm to 5:00pm UK Time)
Email: ONlit@hibbertco.com

ASIA/PACIFIC: LDC for ON Semiconductor – Asia Support

Phone: 303-675-2121 (Tue-Fri 9:00am to 1:00pm, Hong Kong Time)
Toll Free from Hong Kong 800-4422-3781
Email: ONlit-asia@hibbertco.com

JAPAN: ON Semiconductor, Japan Customer Focus Center
4-32-1 Nishi-Gotanda, Shinagawa-ku, Tokyo, Japan 141-8549

Phone: 81-3-5487-8345
Email: r14153@onsemi.com

Fax Response Line: 303-675-2167
800-344-3810 Toll Free USA/Canada

ON Semiconductor Website: <http://onsemi.com>

For additional information, please contact your local
Sales Representative.