

S10WB60

600V 10A

OUTLINE DIMENSIONS

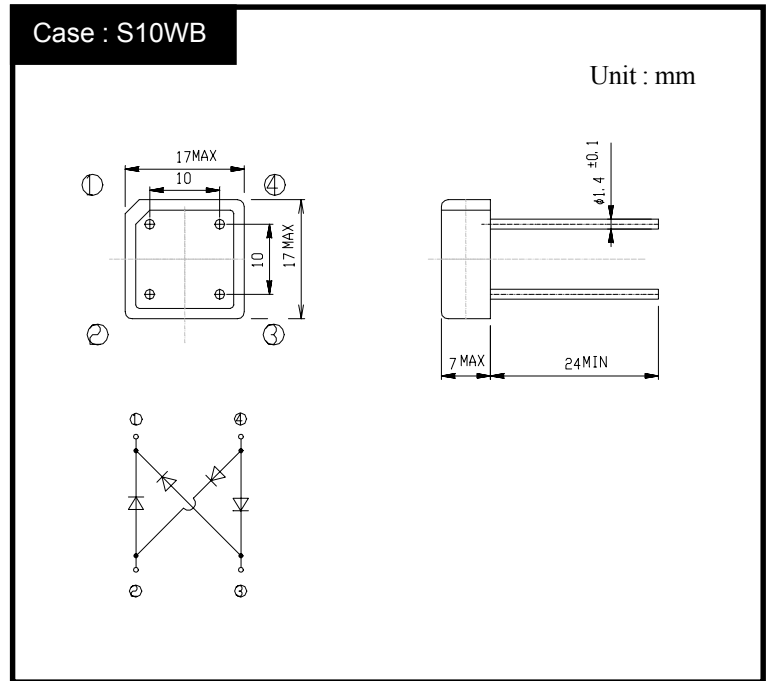

RATINGS

● Absolute Maximum Ratings

Item	Symbol	Conditions	Ratings	Unit
Storage Temperature	T _{stg}		-40~150	°C
Operating Junction Temperature	T _j		150	°C
Maximum Reverse Voltage	V _{RM}		600	V
Average Rectified Forward Current	I _O	50Hz sine wave, R-load With heatsink T _c =74°C	10	A
		50Hz sine wave, R-load Without heatsink T _a =25°C	3.2	
Peak Surge Forward Current	I _{FSM}	50Hz sine wave, Non-repetitive 1cycle peak value, T _j =25°C	170	A
Current Squared Time	I ² t	1ms ≤ t < 10ms T _c =25°C	110	A ² s
Dielectric Strength	V _{dis}	Terminals to case, AC 1 minute	2	kV
Mounting Torque	TOR	(Recommended torque : 0.5N·m)	0.8	N·m

● Electrical Characteristics (T_c=25°C)

Item	Symbol	Conditions	Ratings	Unit
Forward Voltage	V _F	I _F =5A, Pulse measurement, Rating of per diode	Max.1.05	V
Reverse Current	I _R	V _R =V _{RM} , Pulse measurement, Rating of per diode	Max.10	μA
Thermal Resistance	θ _{jc}	junction to case, With heatsink	Max.3.9	°C/W
	θ _{jl}	junction to lead, Without heatsink	Max.4	
	θ _{ja}	junction to ambient, Without heatsink	Max.24	

S10WBx

Forward Voltage

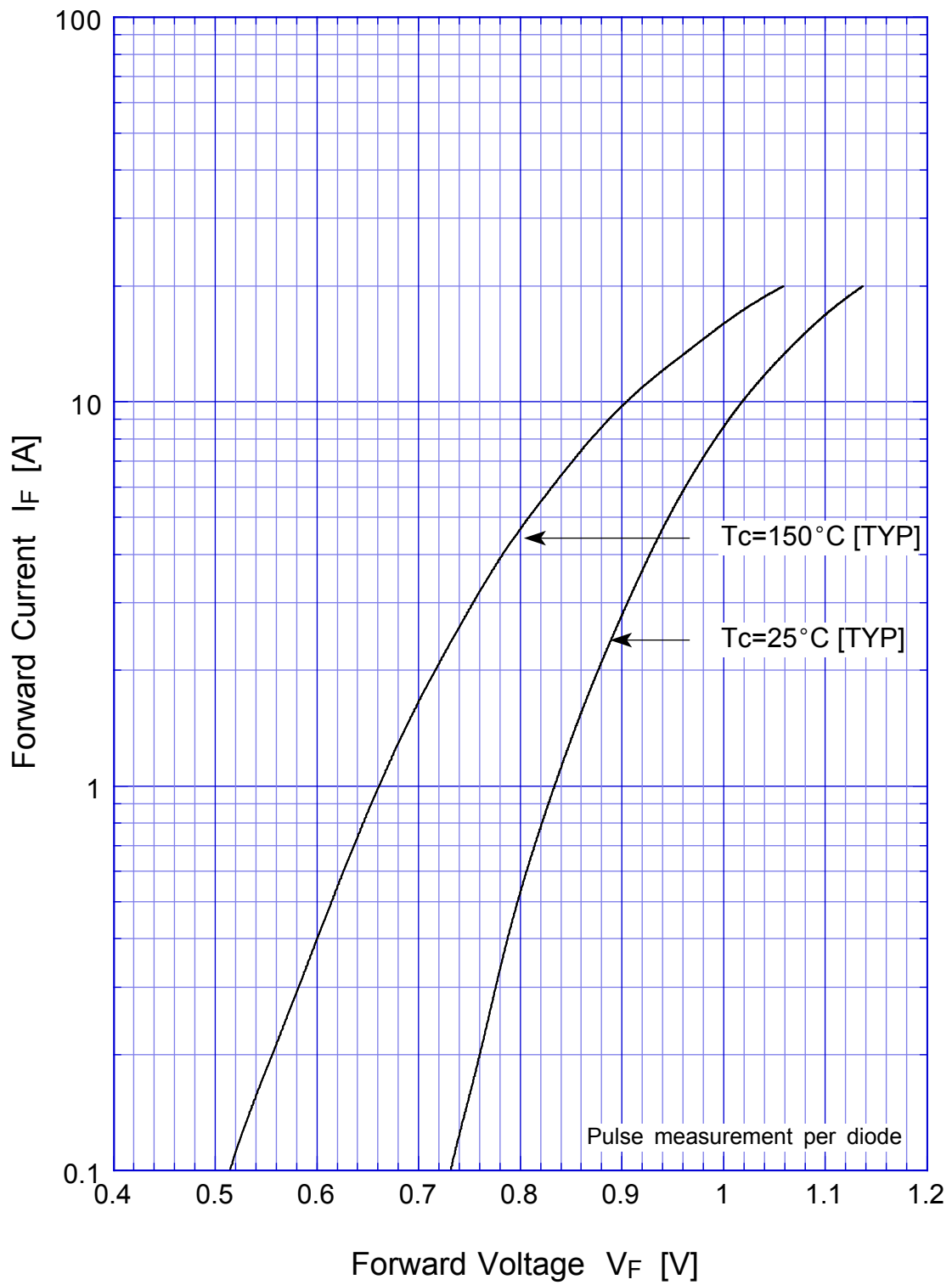

S10WBx Forward Power Dissipation

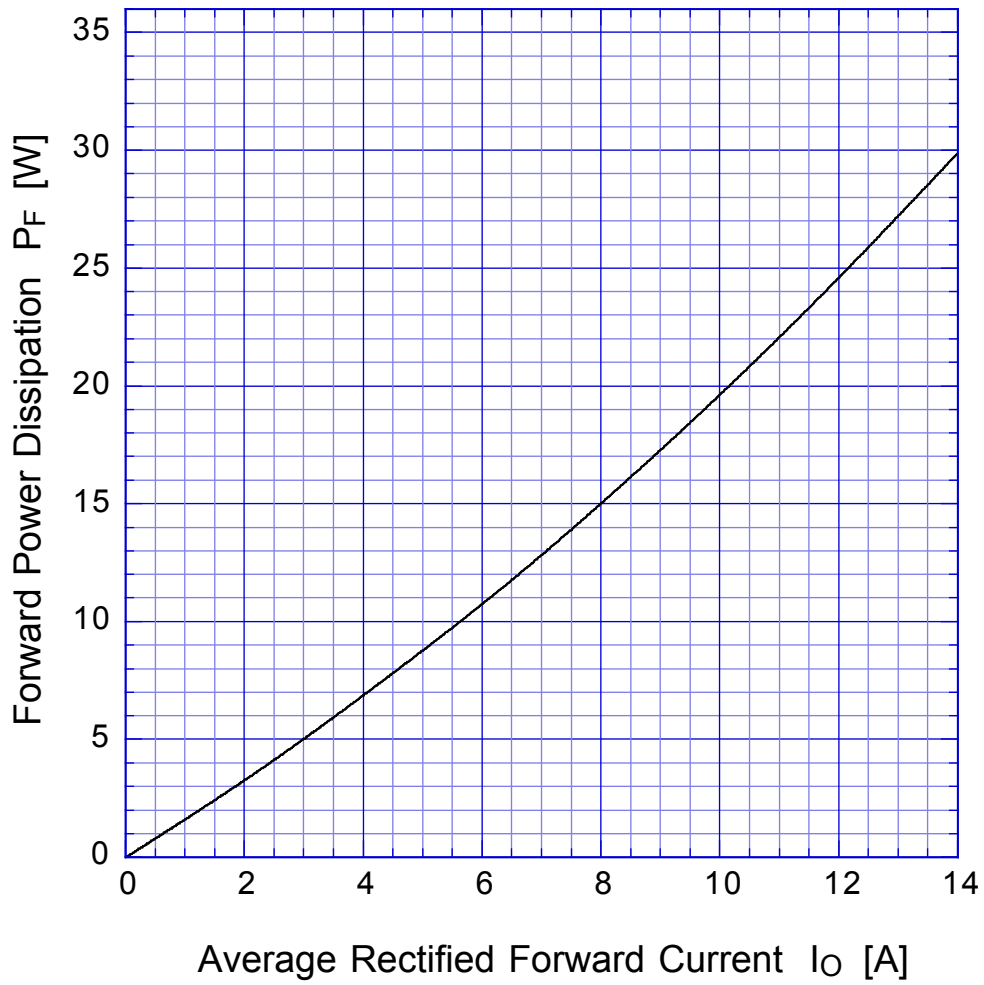

$T_j = 150^\circ\text{C}$
Sine wave

S10WBx Forward Power Dissipation

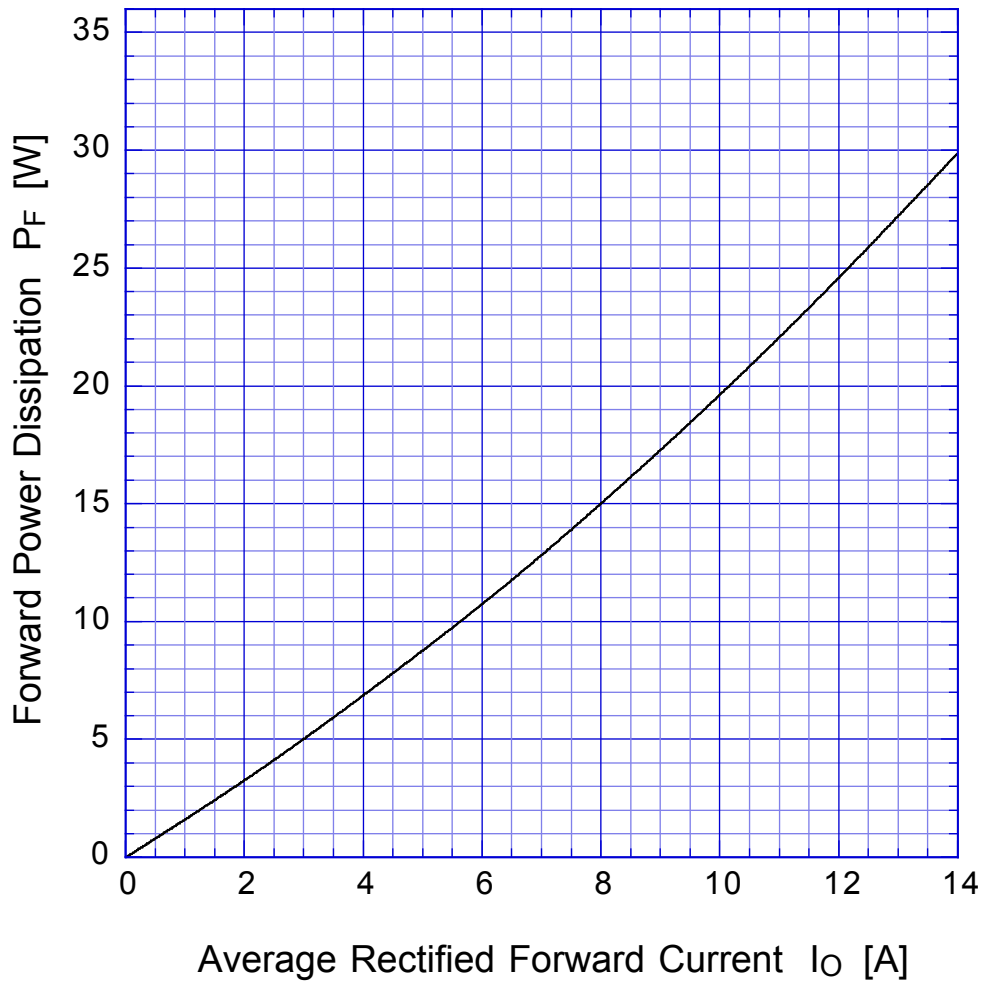

$T_j = 150^\circ\text{C}$
Sine wave

S10WBx

Derating Curve

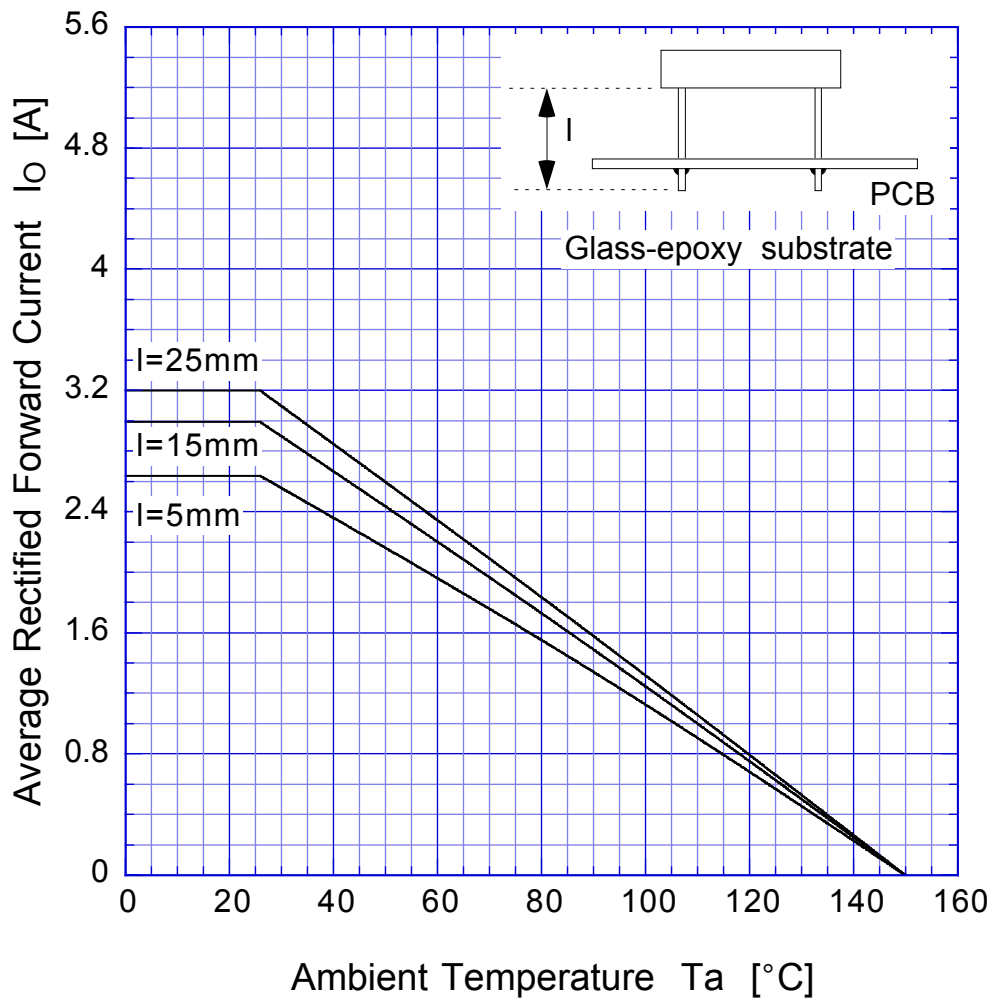

Sine wave
R-load
Free in air
no heatsink

S10WBx

Peak Surge Forward Capability

