

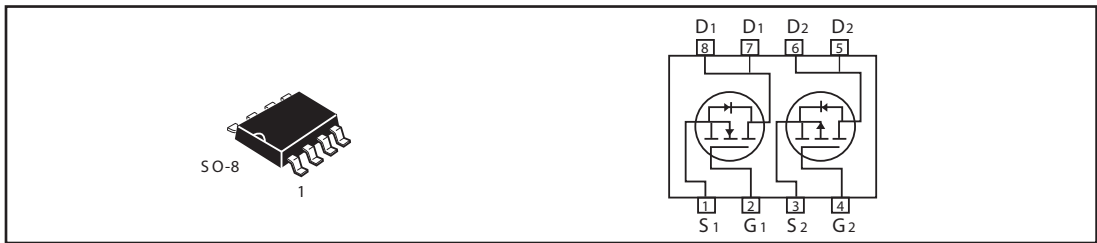

## Dual Enhancement Mode Field Effect Transistor ( N and P Channel)

PRODUCT SUMMARY (N-Channel)		
V <sub>DSS</sub>	I <sub>D</sub>	R <sub>DS(ON)</sub> ( mΩ ) TYP
30V	6A	18.5 @ V <sub>GS</sub> = 10V
		25 @ V <sub>GS</sub> = 4.5V

PRODUCT SUMMARY (P-Channel)		
V <sub>DSS</sub>	I <sub>D</sub>	R <sub>DS(ON)</sub> ( mΩ ) TYP
-30V	-4.5A	38.5 @ V <sub>GS</sub> = -10V
		57.5 @ V <sub>GS</sub> = -4.5V



### ABSOLUTE MAXIMUM RATINGS (T<sub>A</sub>=25 °C unless otherwise noted)

Parameter	Symbol	N-Channel	P-Channel	Unit
Drain-Source Voltage	V <sub>DS</sub>	30	-30	V
Gate-Source Voltage	V <sub>GS</sub>	±20	±20	V
Drain Current-Continuous <sup>a</sup> @ T <sub>J</sub> =125 °C -Pulsed <sup>b</sup>	I <sub>D</sub>	±6.0	±4.5	A
	I <sub>DM</sub>	±18.0	±15	A
Drain-Source Diode Forward Current <sup>a</sup>	I <sub>S</sub>	1.7	-1.7	A
Maximum Power Dissipation <sup>a</sup>	P <sub>D</sub>	2.0		W
Operating Junction and Storage Temperature Range	T <sub>J</sub> , T <sub>STG</sub>	-55 to 150		°C

### THERMAL CHARACTERISTICS

Thermal Resistance, Junction-to-Ambient <sup>a</sup>	R θ <sub>JA</sub>	62.5	°C/W
--	-------------------	------	------

# S DM8401

N-Channel ELECTRICAL CHARACTERISTICS ( $T_A = 25\text{ }^{\circ}\text{C}$  unless otherwise noted)

Parameter	Symbol	Condition	Min	Typ <sup>c</sup>	Max	Unit
<b>OFF CHARACTERISTICS</b>						
Drain-Source Breakdown Voltage	$BV_{DSS}$	$V_{GS}=0V, I_D=250\mu A$	30			V
Zero Gate Voltage Drain Current	$I_{DSS}$	$V_{DS}=24V, V_{GS}=0V$			1	$\mu A$
Gate-Body Leakage	$I_{GSS}$	$V_{GS}=\pm 16V, V_{DS}=0V$			$\pm 100$	nA
<b>ON CHARACTERISTICS<sup>b</sup></b>						
Gate Threshold Voltage	$V_{GS(th)}$	$V_{DS}=V_{GS}, I_D=250\mu A$	1	1.5	3	V
Drain-Source On-State Resistance	$R_{DS(ON)}$	$V_{GS}=10V, I_D=9A$		18.5	21	m ohm
		$V_{GS}=4.5V, I_D=7A$		25	32	m ohm
On-State Drain Current	$I_{D(ON)}$	$V_{DS}=10V, V_{GS}=10V$	40			A
Forward Transconductance	$g_{FS}$	$V_{DS}=10V, I_D=20A$		16		S
<b>DYNAMIC CHARACTERISTICS<sup>c</sup></b>						
Input Capacitance	$C_{ISS}$	$V_{DS}=15V, V_{GS}=0V$ $f=1.0MHz$		950		pF
Output Capacitance	$C_{OSS}$			420		pF
Reverse Transfer Capacitance	$C_{RSS}$			110		pF
<b>SWITCHING CHARACTERISTICS<sup>c</sup></b>						
Turn-On Delay Time	$t_{D(ON)}$	$V_{DD}=15V,$ $I_D=1A,$ $V_{GS}=10V,$ $R_{GEN}=6$		7		ns
Rise Time	$t_r$			30		ns
Turn-Off Delay Time	$t_{D(OFF)}$			14		ns
Fall Time	$t_f$			54		ns
Total Gate Charge	$Q_g$	$V_{DS}=15V, I_D=9A, V_{GS}=10V$		25.2	35	nC
		$V_{DS}=15V, I_D=9A, V_{GS}=4.5V$		12.1	14.6	nC
Gate-Source Charge	$Q_{gs}$	$V_{DS}=15V, I_D=9A,$ $V_{GS}=10V$		5.12		nC
Gate-Drain Charge	$Q_{gd}$			4.8		nC

# S DM8401

P-Channel ELECTRICAL CHARACTERISTICS ( $T_A=25^{\circ}\text{C}$  unless otherwise noted)

Parameter	Symbol	Condition	Min	Typ <sup>c</sup>	Max	Unit
<b>OFF CHARACTERISTICS</b>						
Drain-Source Breakdown Voltage	$BV_{DSS}$	$V_{GS}=0V, I_D=-250\mu A$	-30			V
Zero Gate Voltage Drain Current	$I_{DSS}$	$V_{DS}=-24V, V_{GS}=0V$			-1	$\mu A$
Gate-Body Leakage	$I_{GSS}$	$V_{GS}=\pm 20V, V_{DS}=0V$			$\pm 100$	nA
<b>ON CHARACTERISTICS<sup>b</sup></b>						
Gate Threshold Voltage	$V_{GS(th)}$	$V_{DS}=V_{GS}, I_D=-250\mu A$	-1	-1.5	-3	V
Drain-Source On-State Resistance	$R_{DS(ON)}$	$V_{GS}=-10V, I_D=-4.5A$		38.5	53	m ohm
		$V_{GS}=-4.5V, I_D=-3.6A$		57.5	95	m ohm
On-State Drain Current	$I_{D(ON)}$	$V_{DS}=-5V, V_{GS}=-10V$	-20			A
Forward Transconductance	$g_{FS}$	$V_{DS}=-15V, I_D=-4.5A$	5	10		S
<b>DYNAMIC CHARACTERISTICS<sup>c</sup></b>						
Input Capacitance	$C_{ISS}$	$V_{DS}=-15V, V_{GS}=0V$ $f=1.0\text{MHz}$		860		pF
Output Capacitance	$C_{OSS}$			457		pF
Reverse Transfer Capacitance	$C_{RSS}$			140		pF
<b>SWITCHING CHARACTERISTICS<sup>c</sup></b>						
Turn-On Delay Time	$t_{D(ON)}$	$V_D=-15V,$ $R_L=15$ $I_D=-1A,$ $V_{GEN}=-10V,$ $R_{GEN}=6$		9	20	ns
Rise Time	$t_r$			10	40	ns
Turn-Off Delay Time	$t_{D(OFF)}$			37	90	ns
Fall Time	$t_f$			23	110	ns
Total Gate Charge	$Q_g$	$V_{DS}=-15V, I_D=-4.9A, V_{GS}=-10V$		15	20	nC
		$V_{DS}=-15V, I_D=-4.9A, V_{GS}=-4.5V$		8	10	nC
Gate-Source Charge	$Q_{gs}$	$V_{DS}=-15V, I_D=-4.9A,$ $V_{GS}=-10V$		3		nC
Gate-Drain Charge	$Q_{gd}$			4		nC

# S DM8401

## ELECTRICAL CHARACTERISTICS ( $T_A=25^\circ\text{C}$ unless otherwise noted)

Parameter	Symbol	Condition	Min	Typ <sup>c</sup>	Max	Unit	
DRAIN-SOURCE DIODE CHARACTERISTICS <sup>b</sup>							
Diode Forward Voltage	$V_{SD}$	$V_{GS} = 0\text{V}, I_s = 1.7\text{A}$	N-Ch		0.77	1.2	V
		$V_{GS} = 0\text{V}, I_s = -1.7\text{A}$	P-Ch		-0.80	-1.2	

### Notes

- a. Surface Mounted on FR4 Board,  $t \leq 10\text{sec}$ .
  - b. Pulse Test: Pulse Width  $\leq 300 \mu\text{s}$ , Duty Cycle  $\leq 2\%$ .
  - c. Guaranteed by design, not subject to production testing.
- N-Channel

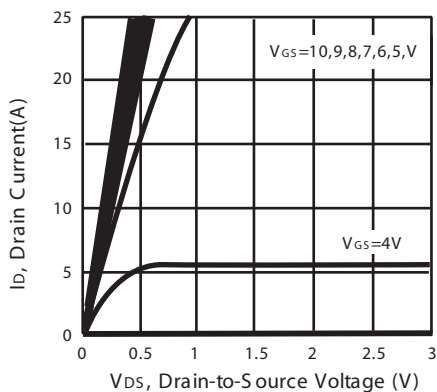

Figure 1. Output Characteristics

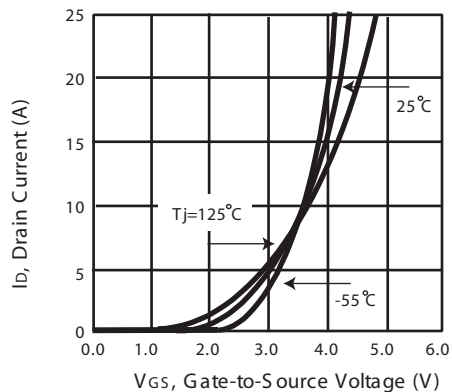

Figure 2. Transfer Characteristics

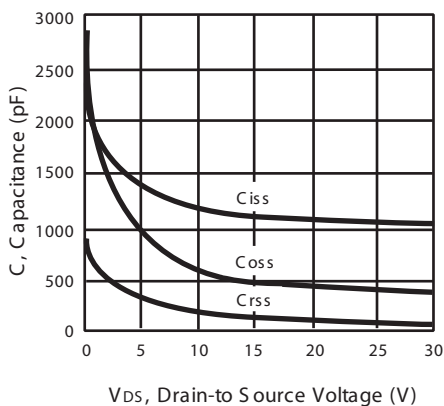

Figure 3. Capacitance

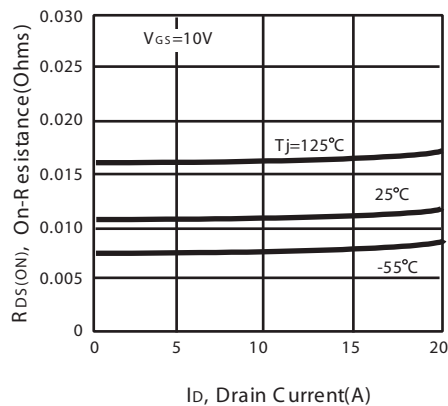

Figure 4. On-R resistance Variation with Drain Current and Temperature

# S DM8401

## N-Channel

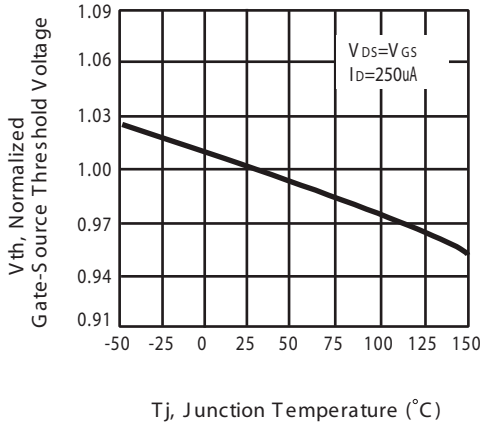

Figure 5. Gate Threshold Variation with Temperature

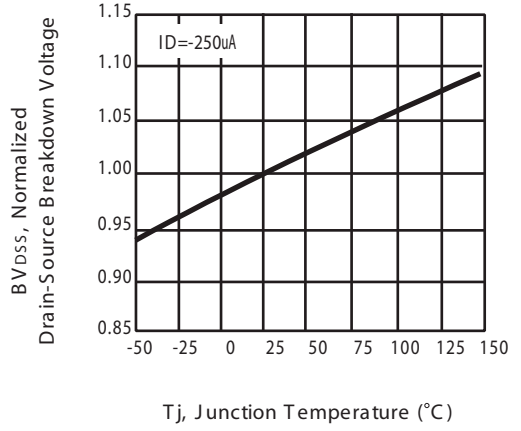
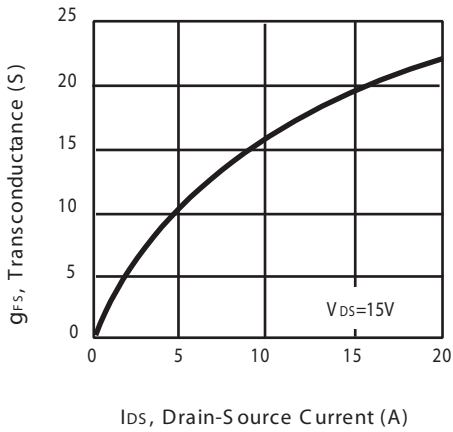

Figure 6. Breakdown Voltage Variation with Temperature



with Drain Current

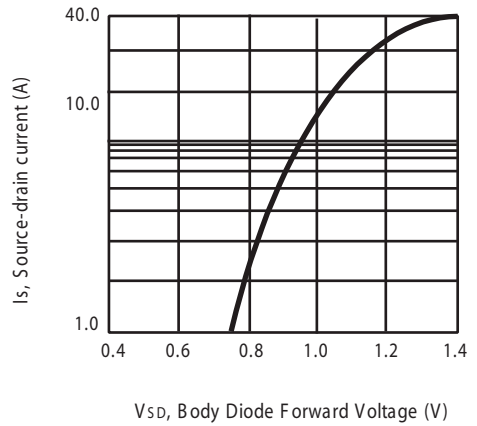

Figure 8. Body Diode Forward Voltage Variation with Source Current

# S DM8401

## P-Channel

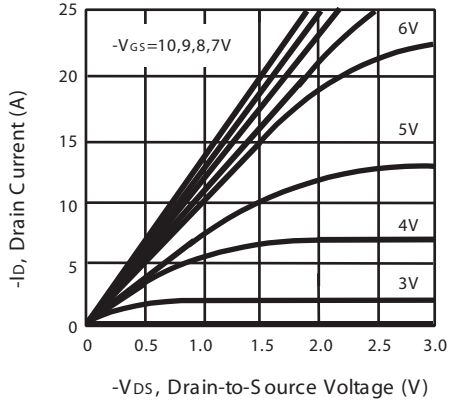

Figure 1. Output Characteristics

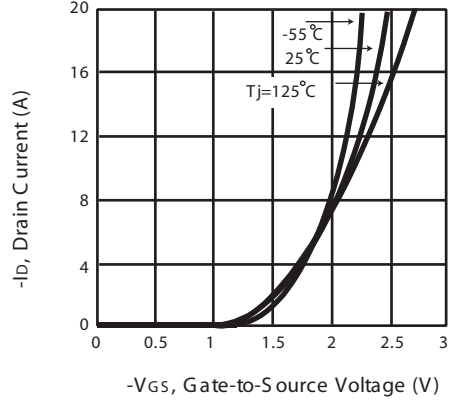

Figure 2. Transfer Characteristics

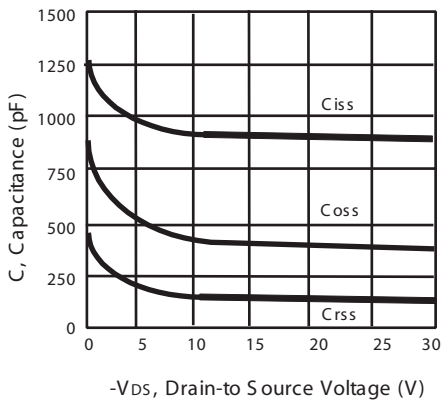

Figure 3. Capacitance

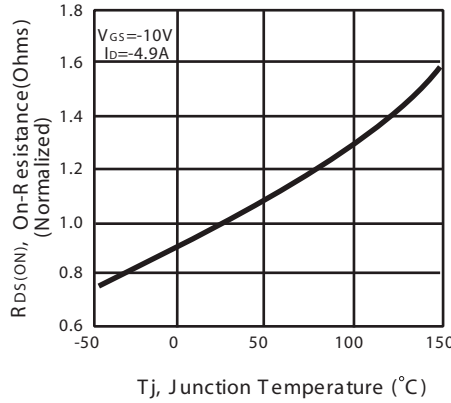

Figure 4. On-Resistance Variation with Temperature

# S DM8401

## P-Channel

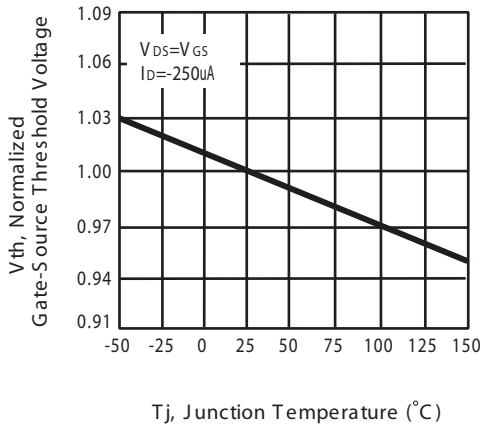

Figure 5. Gate Threshold Voltage Variation with Temperature

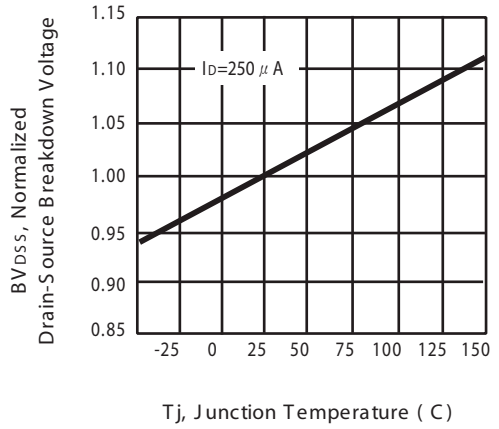

Figure 6. Breakdown Voltage Variation with Temperature

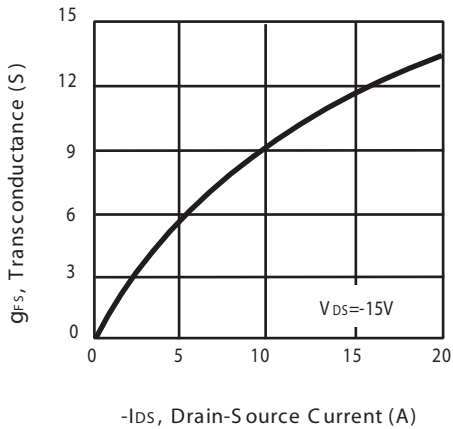

Figure 7. Transconductance Variation with Drain Current

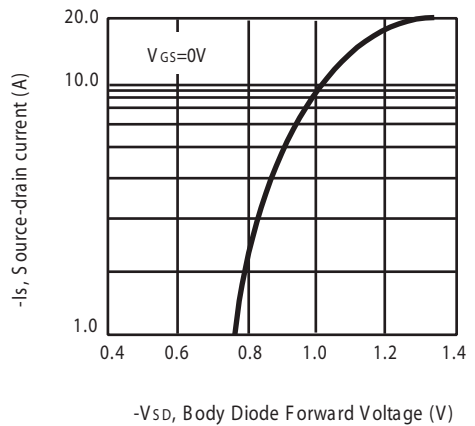
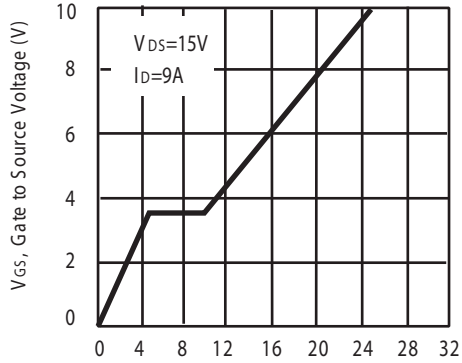

Figure 8. Body Diode Forward Voltage Variation with Source Current

# S DM8401

## N-Channel



Qg, Total Gate Charge (nC)  
Figure 9. Gate Charge

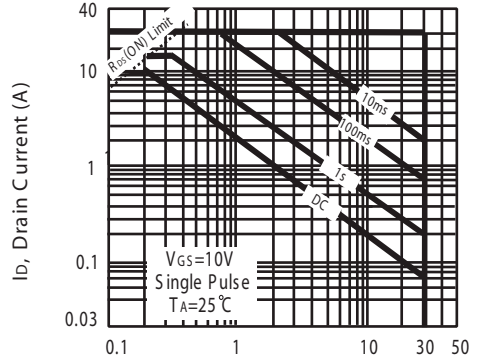

Vds, Drain-Source Voltage (V)  
Figure 10. Maximum Safe Operating Area

## P-Channel

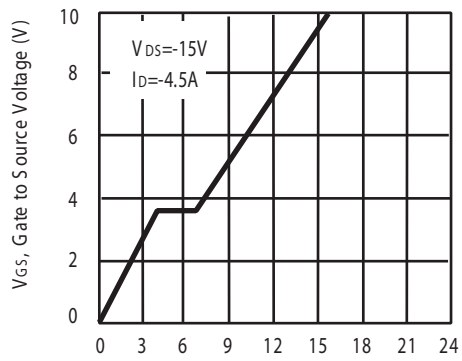

Qg, Total Gate Charge (nC)  
Figure 9. Gate Charge

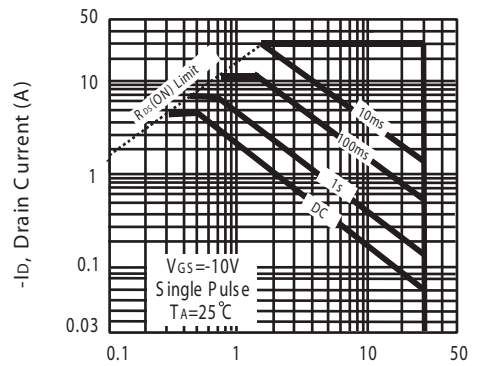

-Vds, Body Diode Forward Voltage (V)  
Figure 10. Maximum Safe Operating Area



# S DM8401

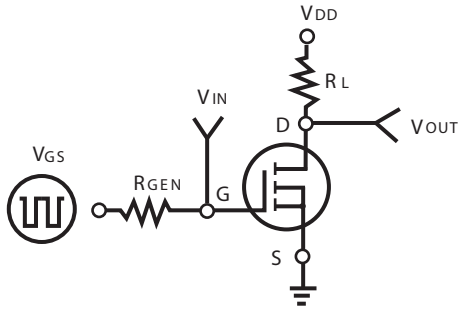

Figure 11. Switching Test Circuit

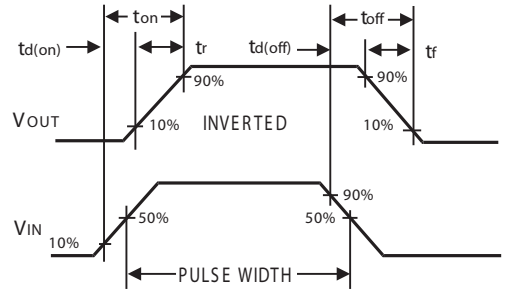

Figure 12. Switching Waveforms

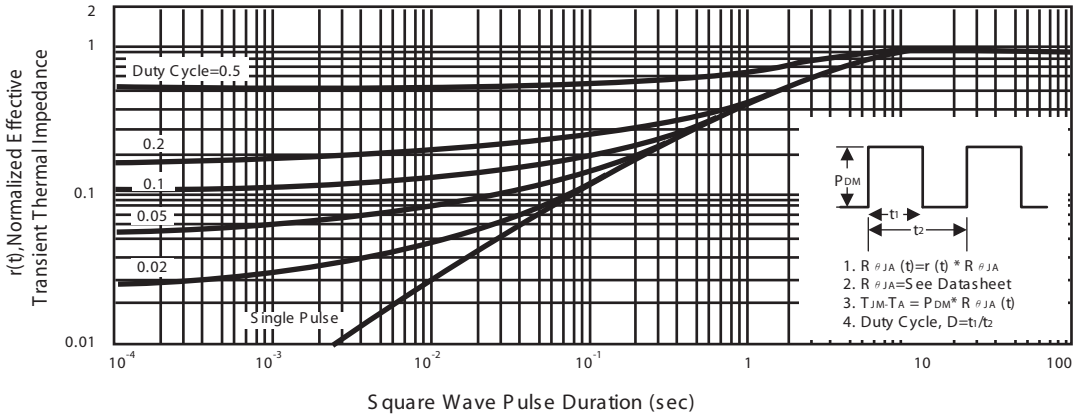

Figure 13. Normalized Thermal Transient Impedance Curve