

**NPN Silicon Transistor for High Voltages**

- High breakdown voltage
- Low collector-emitter saturation voltage
- Complementary types: SMBTA92 (PNP)

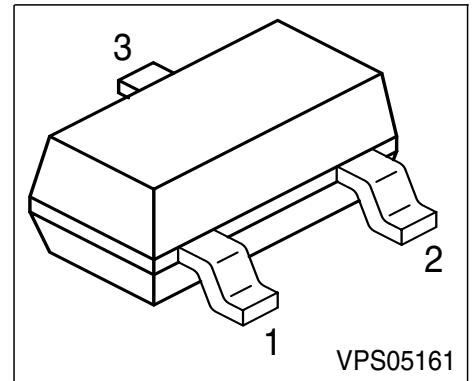

Type	Marking	Pin Configuration			Package
SMBTA42/MMBTA42	s1D	1=B	2=E	3=C	SOT23

**Maximum Ratings**

Parameter	Symbol	Value	Unit
Collector-emitter voltage	$V_{CEO}$	300	V
Collector-base voltage	$V_{CBO}$	300	
Emitter-base voltage	$V_{EBO}$	6	
DC collector current	$I_C$	500	mA
Base current	$I_B$	100	
Total power dissipation, $T_S = 74\text{ °C}$	$P_{tot}$	360	mW
Junction temperature	$T_j$	150	°C
Storage temperature	$T_{stg}$	-65 ... 150	

**Thermal Resistance**

Junction - soldering point <sup>1)</sup>	$R_{thJS}$	≤210	K/W
--	------------	------	-----

<sup>1)</sup>For calculation of  $R_{thJA}$  please refer to Application Note Thermal Resistance

**Electrical Characteristics** at  $T_A = 25^\circ\text{C}$ , unless otherwise specified.

Parameter	Symbol	Values			Unit
		min.	typ.	max.	
<b>DC Characteristics</b>					
Collector-emitter breakdown voltage $I_C = 1\text{ mA}, I_B = 0$	$V_{(BR)CEO}$	300	-	-	V
Collector-base breakdown voltage $I_C = 100\text{ }\mu\text{A}, I_E = 0$	$V_{(BR)CBO}$	300	-	-	
Emitter-base breakdown voltage $I_E = 100\text{ }\mu\text{A}, I_C = 0$	$V_{(BR)EBO}$	6	-	-	
Collector cutoff current $V_{CB} = 200\text{ V}, I_E = 0$	$I_{CBO}$	-	-	100	nA
Collector cutoff current $V_{CB} = 200\text{ V}, I_E = 0, T_A = 150\text{ }^\circ\text{C}$	$I_{CBO}$	-	-	20	$\mu\text{A}$
Emitter cutoff current $V_{EB} = 3\text{ V}, I_C = 0$	$I_{EBO}$	-	-	100	nA
DC current gain 1) $I_C = 1\text{ mA}, V_{CE} = 10\text{ V}$ $I_C = 10\text{ mA}, V_{CE} = 10\text{ V}$ $I_C = 30\text{ mA}, V_{CE} = 10\text{ V}$	$h_{FE}$	25 40 40	- - -	- - -	-
Collector-emitter saturation voltage1) $I_C = 20\text{ mA}, I_B = 2\text{ mA}$	$V_{CEsat}$	-	-	0.5	V
Base-emitter saturation voltage 1) $I_C = 20\text{ mA}, I_B = 2\text{ mA}$	$V_{BEsat}$	-	-	0.9	
<b>AC Characteristics</b>					
Transition frequency $I_C = 10\text{ mA}, V_{CE} = 20\text{ V}, f = 100\text{ MHz}$	$f_T$	50	-	-	MHz
Collector-base capacitance $V_{CB} = 20\text{ V}, f = 1\text{ MHz}$	$C_{cb}$	-	-	4	pF

 1) Pulse test:  $t < 300\mu\text{s}$ ;  $D < 2\%$

**Total power dissipation  $P_{tot} = f(T_S)$**

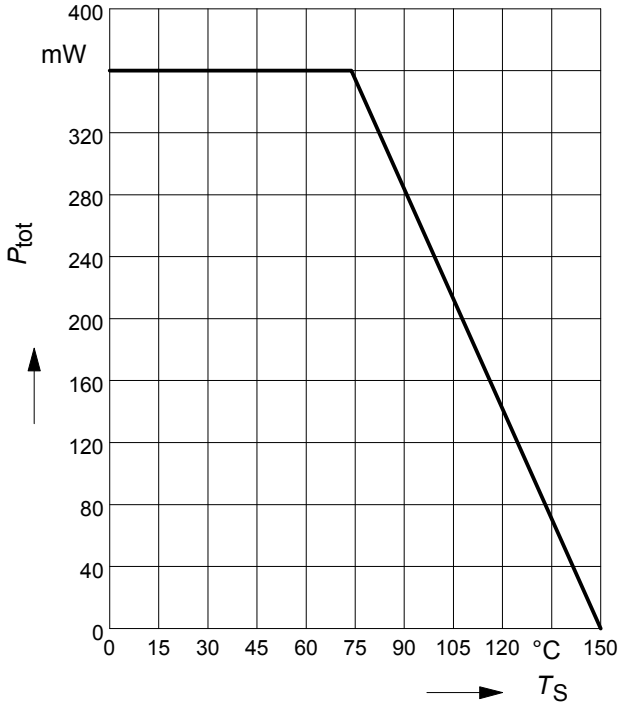

**Transition frequency  $f_T = f(I_C)$**

$V_{CE} = 10V, f = 100MHz$

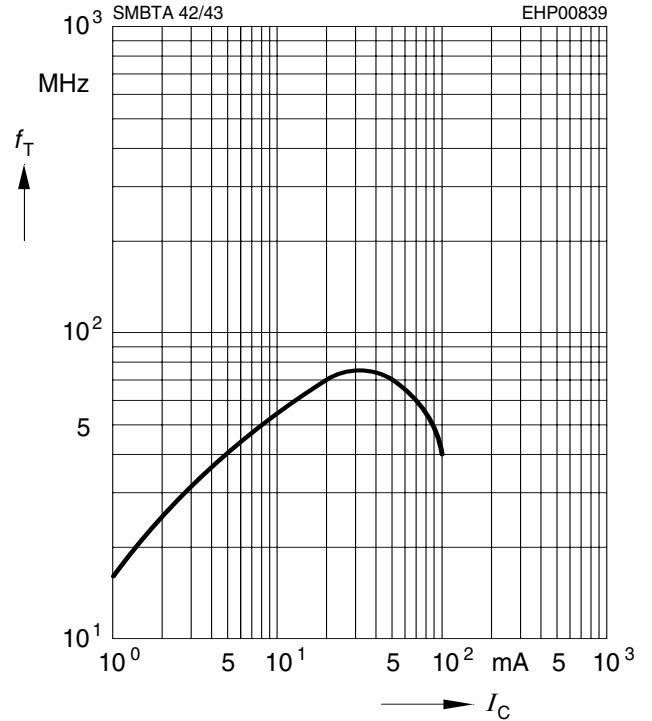

**Permissible pulse load**

$P_{totmax} / P_{totDC} = f(t_p)$

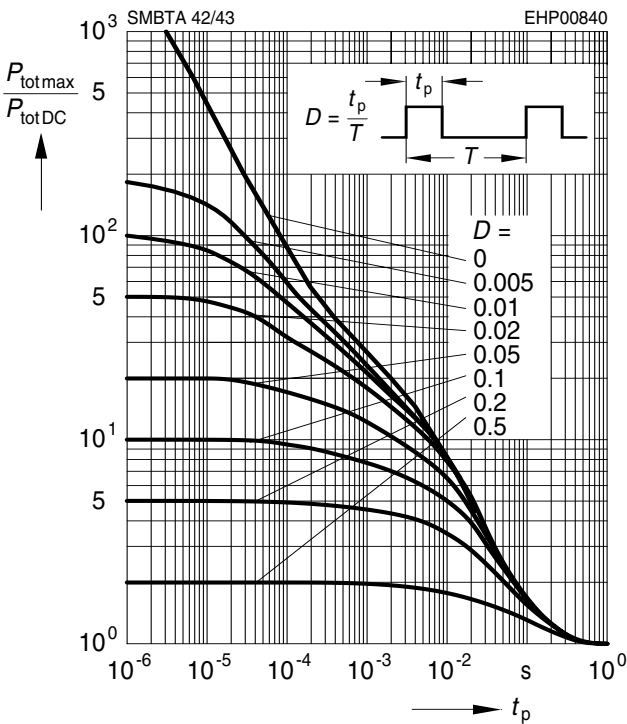

**Operating range  $I_C = f(V_{CE0})$**

$T_A = 25^\circ C, D = 0$

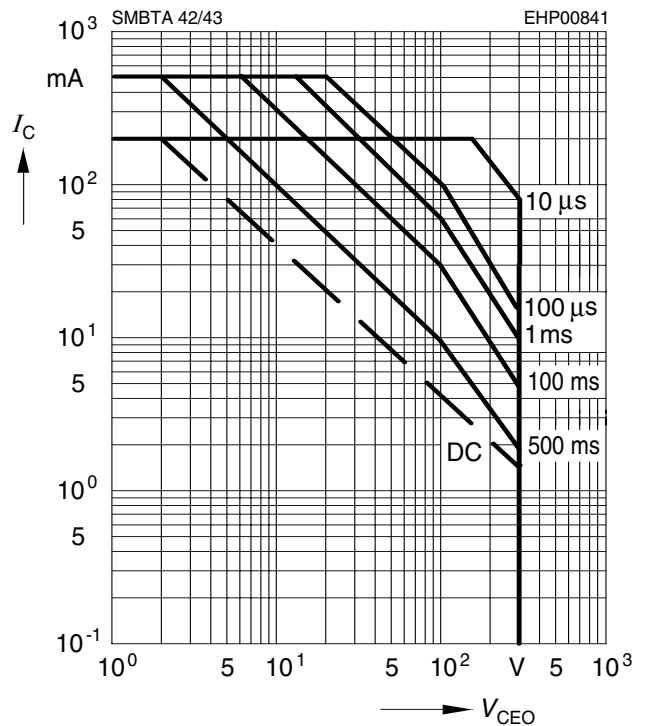

**Collector cutoff current  $I_{CBO} = f(T_A)$**

$V_{CB} = 160V$

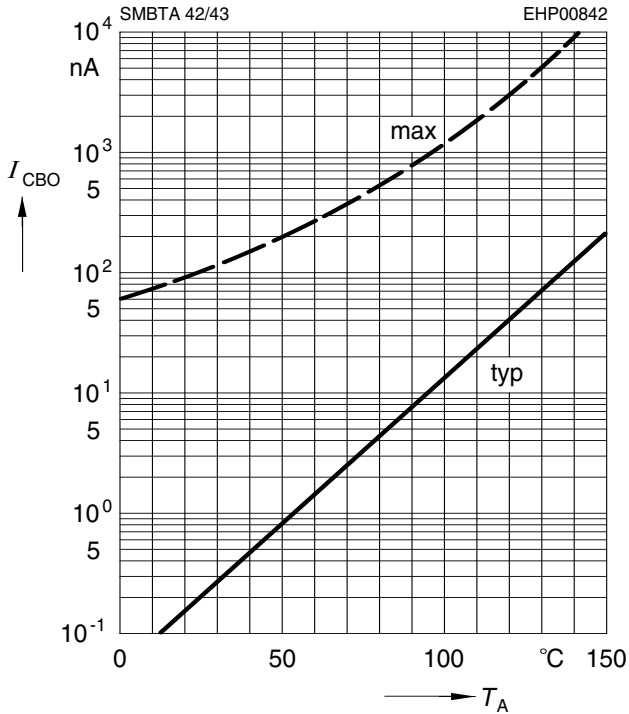

**Collector current  $I_C = f(V_{BE})$**

$V_{CE} = 10V$

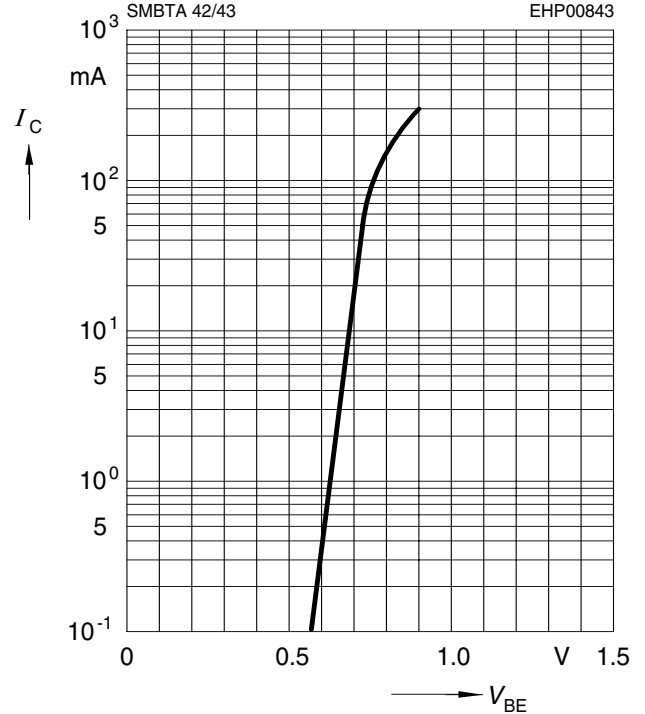

**DC current gain  $h_{FE} = f(I_C)$**

$V_{CE} = 10V$

