

Features

- 35A, 1200V, $T_C = 25^\circ\text{C}$
- 1200V Switching SOA Capability
- Typical Fall Time 350ns at $T_J = 150^\circ\text{C}$
- Short Circuit Rating
- Low Conduction Loss

Ordering Information

PART NUMBER	PACKAGE	BRAND
HGTG15N120C3	TO-247	15N120C3
HGTP15N120C3	TO-220AB	15N120C3
HGT1S15N120C3	TO-262AA	15N120C3
HGT1S15N120C3S	TO-263AB	15N120C3

NOTE: When ordering, use the entire part number. Add the suffix 9A to obtain the TO-263 variant in tape and reel; i.e., HGT1S15N120C3S9A.

Formerly Developmental Type TA49145.

Description

The HGTG15N120C3, HGTP15N120C3, HGT1S15N120C3 and HGT1S15N120C3S are MOS gated high voltage switching devices combining the best features of MOSFETs and bipolar transistors. These devices have the high input impedance of a MOSFET and the low on-state conduction loss of a bipolar transistor. The much lower on-state voltage drop varies only moderately between 25°C and 150°C .

The IGBT is ideal for many high voltage switching applications operating at moderate frequencies where low conduction losses are essential, such as: AC and DC motor controls, power supplies and drivers for solenoids, relays and contactors.

Symbol

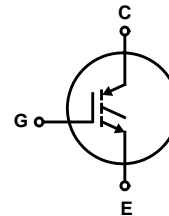

Packaging

JEDEC STYLE TO-247

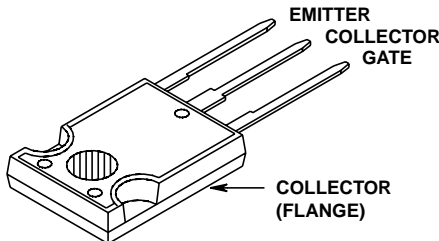

JEDEC TO-220AB (ALTERNATE VERSION)

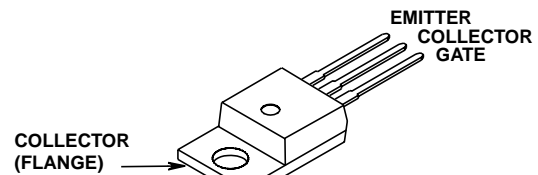

JEDEC TO-262AA

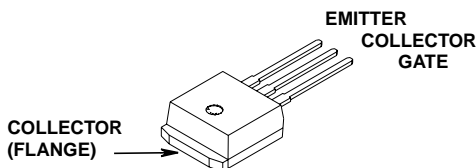

JEDEC TO-263AB

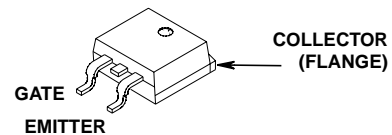

INTERSIL CORPORATION IGBT PRODUCT IS COVERED BY ONE OR MORE OF THE FOLLOWING U.S. PATENTS

4,364,073	4,417,385	4,430,792	4,443,931	4,466,176	4,516,143	4,532,534	4,567,641
4,587,713	4,598,461	4,605,948	4,618,872	4,620,211	4,631,564	4,639,754	4,639,762
4,641,162	4,644,637	4,682,195	4,684,413	4,694,313	4,717,679	4,743,952	4,783,690
4,794,432	4,801,986	4,803,533	4,809,045	4,809,047	4,810,665	4,823,176	4,837,606
4,860,080	4,883,767	4,888,627	4,890,143	4,901,127	4,904,609	4,933,740	4,963,951
4,969,027							

HGTG15N120C3, HGTP15N120C3, HGT1S15N120C3, HGT1S15N120C3S

Absolute Maximum Ratings $T_C = 25^\circ\text{C}$, Unless Otherwise Specified

	HGTG15N120C3, HGTP15N120C3, HGT1S15N120C3S, HGT1S15N120C3S	UNITS
Collector to Emitter Voltage	BV_{CES} 1200	V
Collector Current Continuous		
At $T_C = 25^\circ\text{C}$	I_{C25} 35	A
At $T_C = 110^\circ\text{C}$	I_{C110} 15	A
Collector Current Pulsed (Note 1)	I_{CM} 120	A
Gate to Emitter Voltage Continuous	V_{GES} ± 20	V
Gate to Emitter Voltage Pulsed	V_{GEM} ± 30	V
Switching Safe Operating Area at $T_J = 150^\circ\text{C}$, Figure 14	SSOA 15A at 1200V	
Power Dissipation Total at $T_C = 25^\circ\text{C}$	P_D 164	W
Power Dissipation Derating $T_C > 25^\circ\text{C}$	1.32	W/ $^\circ\text{C}$
Reverse Voltage Avalanche Energy	E_{ARV} 100	mJ
Operating and Storage Junction Temperature Range	T_J, T_{STG} -55 to 150	$^\circ\text{C}$
Maximum Lead Temperature for Soldering	T_L 260	$^\circ\text{C}$
Short Circuit Withstand Time (Note 2) at $V_{GE} = 15\text{V}$	t_{SC} 6	μs
Short Circuit Withstand Time (Note 2) at $V_{GE} = 10\text{V}$	t_{SC} 25	μs

CAUTION: Stresses above those listed in "Absolute Maximum Ratings" may cause permanent damage to the device. This is a stress only rating and operation of the device at these or any other conditions above those indicated in the operational sections of this specification is not implied.

NOTES:

1. Pulse width limited by maximum junction temperature.
2. $V_{CE(PK)} = 720\text{V}$, $T_J = 125^\circ\text{C}$, $R_{GE} = 25\Omega$.

Electrical Specifications $T_C = 25^\circ\text{C}$, Unless Otherwise Specified

PARAMETER	SYMBOL	TEST CONDITIONS	MIN	TYP	MAX	UNITS	
Collector to Emitter Breakdown Voltage	BV_{CES}	$I_C = 250\mu\text{A}$, $V_{GE} = 0\text{V}$	1200	-	-	V	
Emitter to Collector Breakdown Voltage	BV_{ECS}	$I_C = 10\text{mA}$, $V_{GE} = 0\text{V}$	15	25	-	V	
Collector to Emitter Leakage Current	I_{CES}	$V_{CE} = BV_{CES}$	$T_C = 25^\circ\text{C}$	-	-	250	μA
			$T_C = 150^\circ\text{C}$	-	-	3.0	mA
Collector to Emitter Saturation Voltage	$V_{CE(SAT)}$	$I_C = I_{C110}$, $V_{GE} = 15\text{V}$	$T_C = 25^\circ\text{C}$	-	2.3	3.5	V
			$T_C = 150^\circ\text{C}$	-	2.4	3.2	V
Gate to Emitter Threshold Voltage	$V_{GE(TH)}$	$I_C = 250\mu\text{A}$, $V_{CE} = V_{GE}$	4.0	5.6	7.5	V	
Gate to Emitter Leakage Current	I_{GES}	$V_{GE} = \pm 20\text{V}$	-	-	± 100	nA	
Switching SOA	SSOA	$T_J = 150^\circ\text{C}$, $R_G = 10\Omega$, $V_{GE} = 15\text{V}$, $L = 1\text{mH}$	$V_{CE(PK)} = 960\text{V}$	40	-	-	A
			$V_{CE(PK)} = 1200\text{V}$	15	-	-	A
Gate to Emitter Plateau Voltage	V_{GEP}	$I_C = I_{C110}$, $V_{CE} = 0.5 BV_{CES}$	-	8.8	-	V	
On-State Gate Charge	$Q_{g(ON)}$	$I_C = I_{C110}$, $V_{CE} = 0.5 BV_{ES}$	$V_{GE} = 15\text{V}$	-	75	100	nC
			$V_{GE} = 20\text{V}$	-	100	130	nC
Current Turn-On Delay Time	$t_{d(ON)I}$	$T_J = 150^\circ\text{C}$ $I_{CE} = I_{C110}$ $V_{CE(PK)} = 0.8 BV_{CES}$ $V_{GE} = 15\text{V}$ $R_G = 10\Omega$ $L = 1\text{mH}$	-	17	-	ns	
Current Rise Time	t_{rI}		-	25	-	ns	
Current Turn-Off Delay Time	$t_{d(OFF)I}$		-	470	550	ns	
Current Fall Time	t_{fI}		-	350	400	ns	
Turn-On Energy	E_{ON}		-	2100	-	μJ	
Turn-Off Energy (Note 3)	E_{OFF}		-	4700	-	μJ	
Thermal Resistance	$R_{\theta JC}$		-	-	0.76	$^\circ\text{C/W}$	

NOTE:

3. Turn-Off Energy Loss (E_{OFF}) is defined as the integral of the instantaneous power loss starting at the trailing edge of the input pulse and ending at the point where the collector current equals zero ($I_{CE} = 0\text{A}$). All devices were tested per JEDEC standard No. 24-1 Method for Measurement of Power Device Turn-Off Switching Loss. This test method produces the true total Turn-Off Energy Loss. Turn-On losses include losses due to diode recovery.

Typical Performance Curves

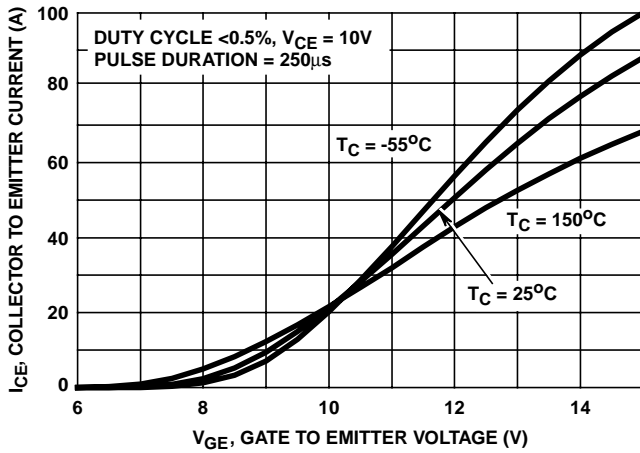

FIGURE 1. TRANSFER CHARACTERISTICS

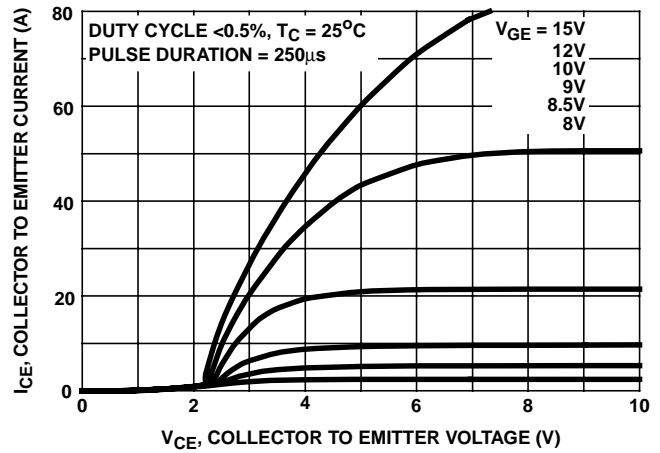

FIGURE 2. SATURATION CHARACTERISTICS

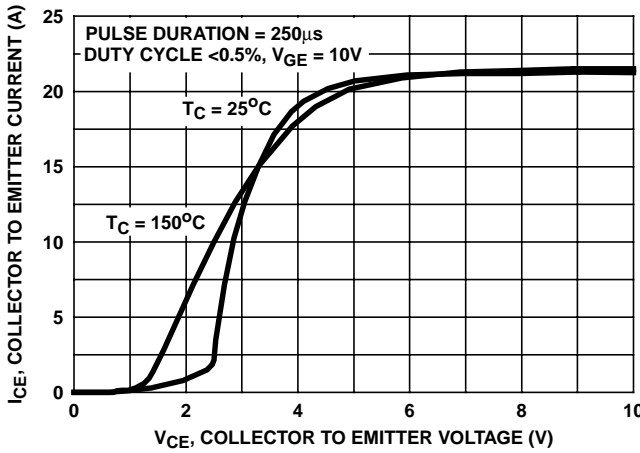

FIGURE 3. COLLECTOR TO EMITTER ON-STATE VOLTAGE

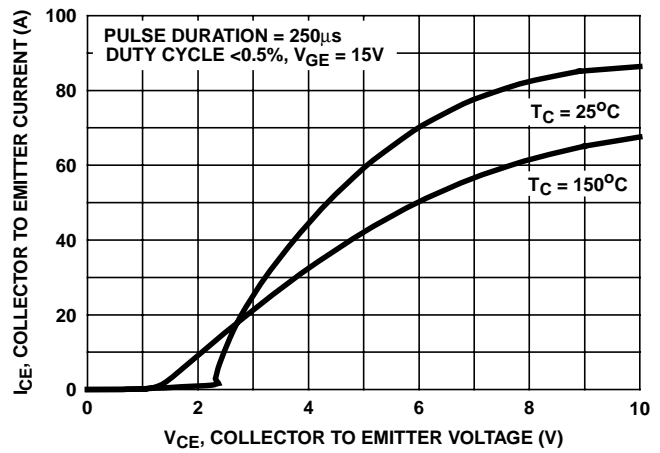

FIGURE 4. COLLECTOR TO EMITTER ON-STATE VOLTAGE

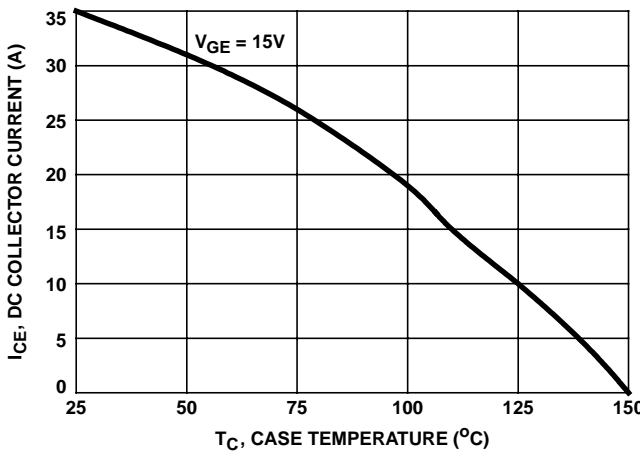

FIGURE 5. DC COLLECTOR CURRENT AS A FUNCTION OF CASE TEMPERATURE

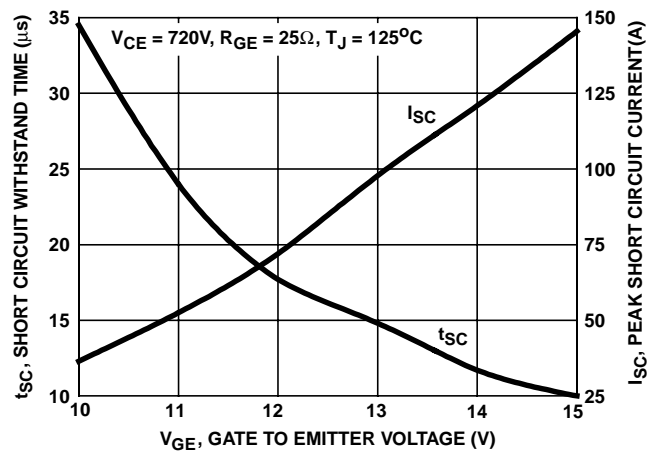

FIGURE 6. SHORT CIRCUIT WITHSTAND TIME

Typical Performance Curves (Continued)

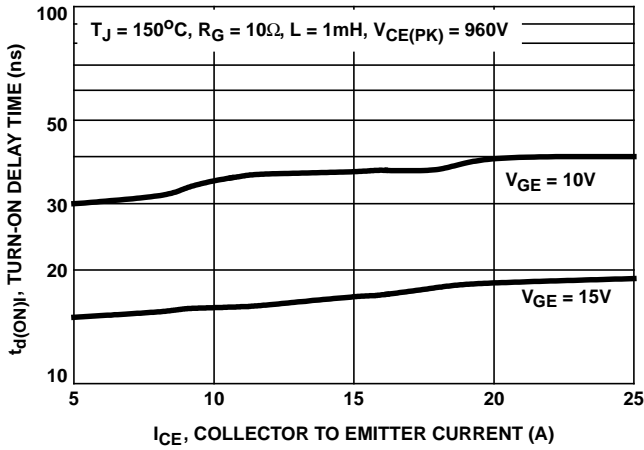

FIGURE 7. TURN-ON DELAY TIME AS A FUNCTION OF COLLECTOR TO EMITTER CURRENT

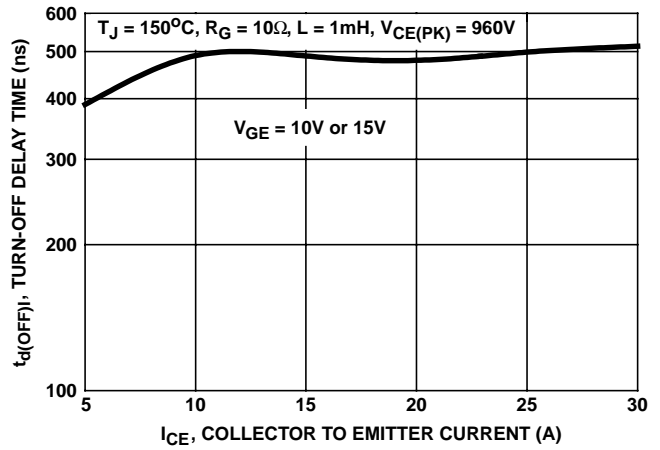

FIGURE 8. TURN-OFF DELAY TIME AS A FUNCTION OF COLLECTOR TO EMITTER CURRENT

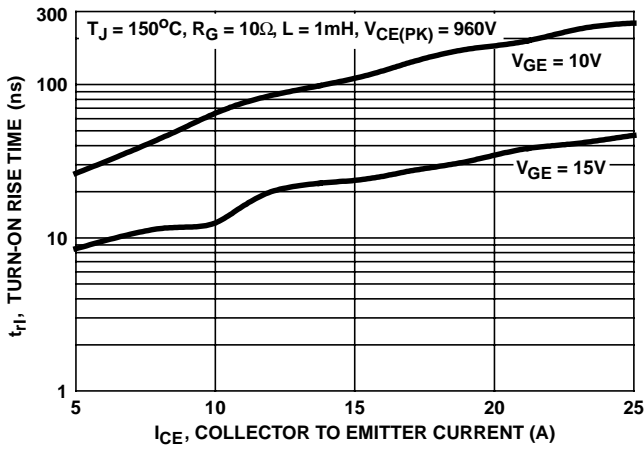

FIGURE 9. TURN-ON RISE TIME AS A FUNCTION OF COLLECTOR TO EMITTER CURRENT

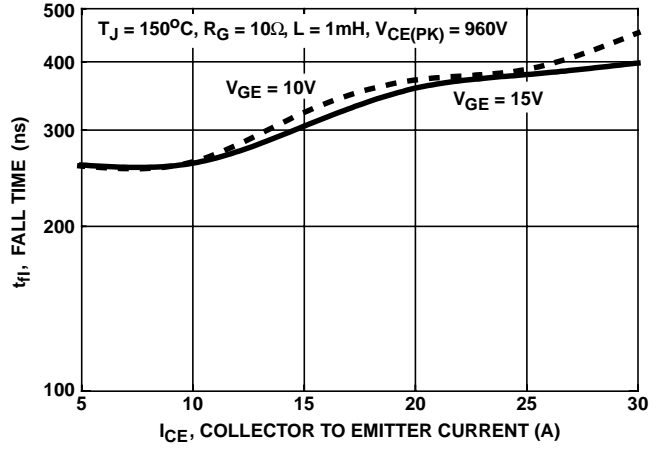

FIGURE 10. TURN-OFF FALL TIME AS A FUNCTION OF COLLECTOR TO EMITTER CURRENT

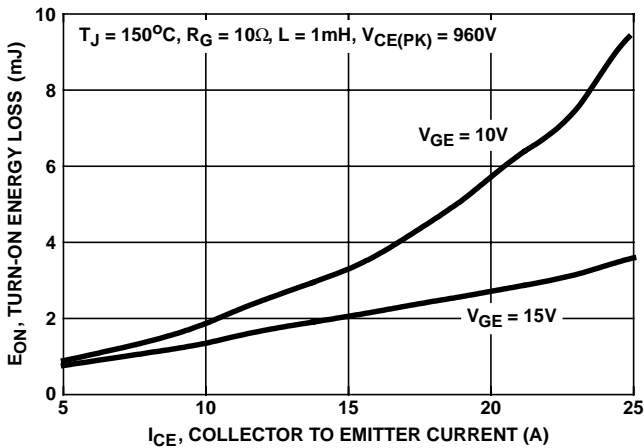

FIGURE 11. TURN-ON ENERGY LOSS AS A FUNCTION OF COLLECTOR TO EMITTER CURRENT

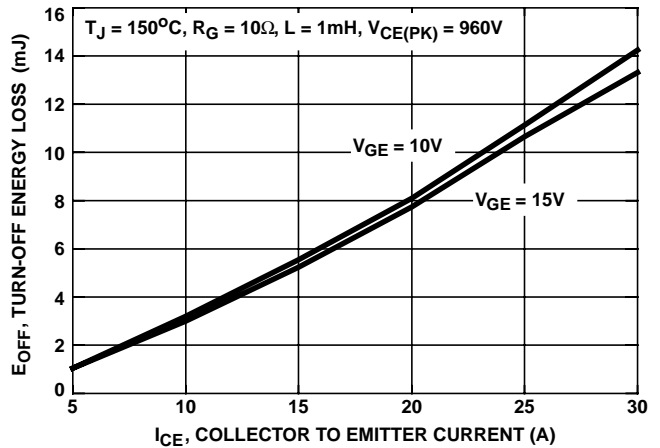

FIGURE 12. TURN-OFF ENERGY LOSS AS A FUNCTION OF COLLECTOR TO EMITTER CURRENT

Typical Performance Curves (Continued)

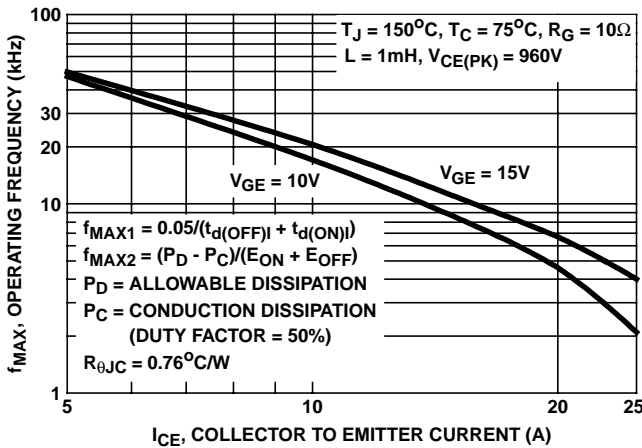

FIGURE 13. OPERATING FREQUENCY AS A FUNCTION OF COLLECTOR TO EMITTER CURRENT

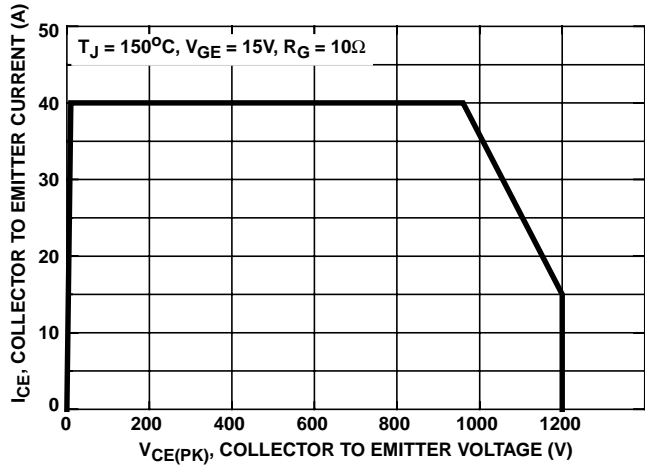

FIGURE 14. SWITCHING SAFE OPERATING AREA

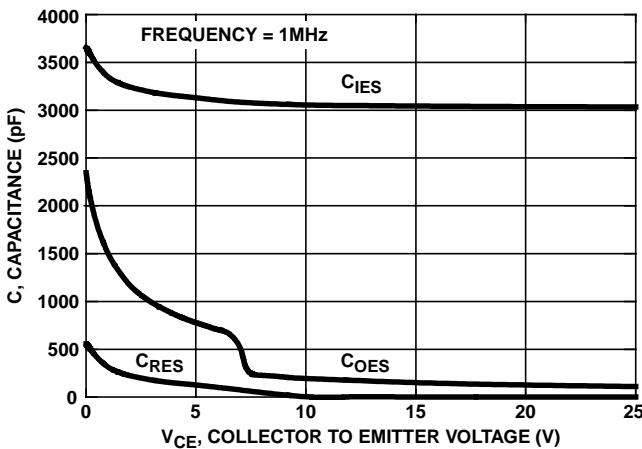

FIGURE 15. CAPACITANCE AS A FUNCTION OF COLLECTOR TO EMITTER VOLTAGE

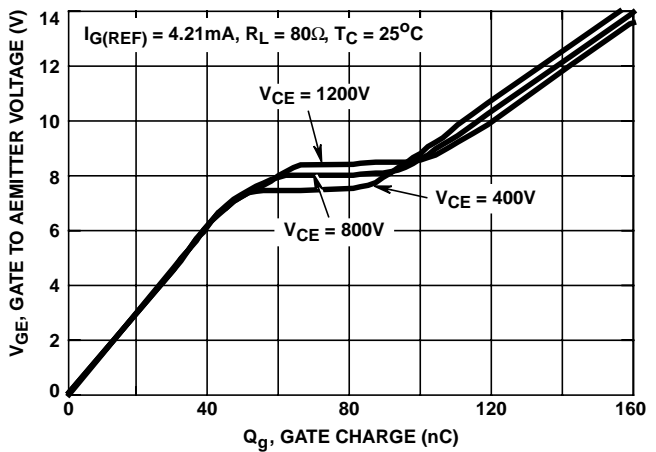

FIGURE 16. GATE CHARGE WAVEFORMS

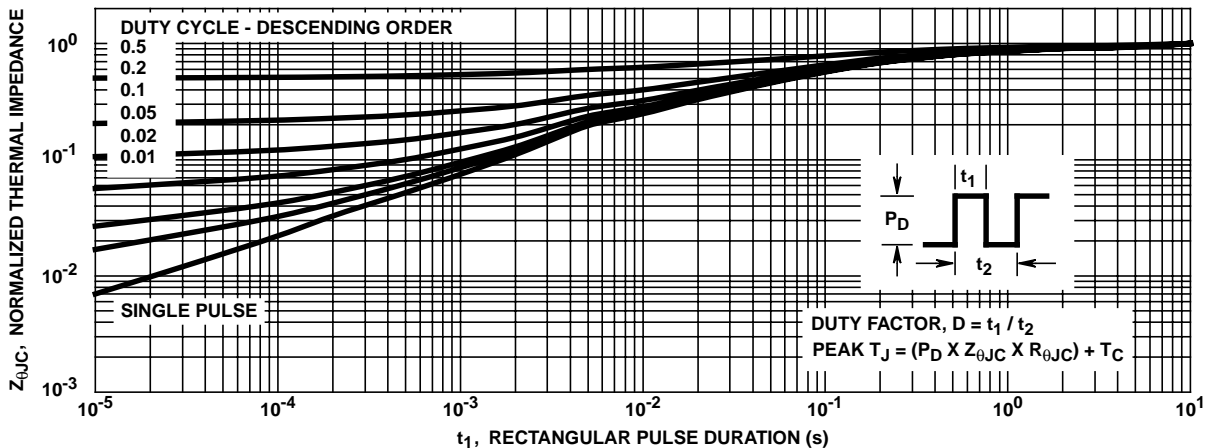

FIGURE 17. IGBT NORMALIZED TRANSIENT THERMAL IMPEDANCE, JUNCTION TO CASE

Test Circuit and Waveforms

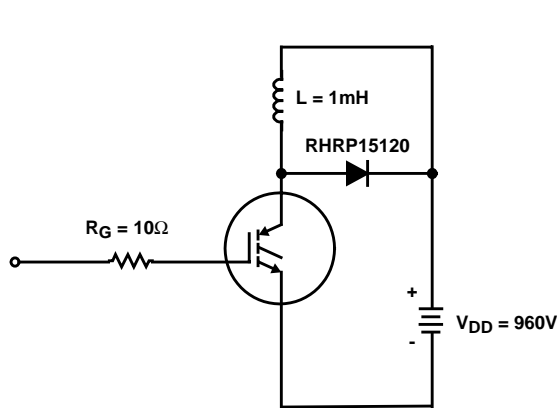

FIGURE 18. INDUCTIVE SWITCHING TEST CIRCUIT

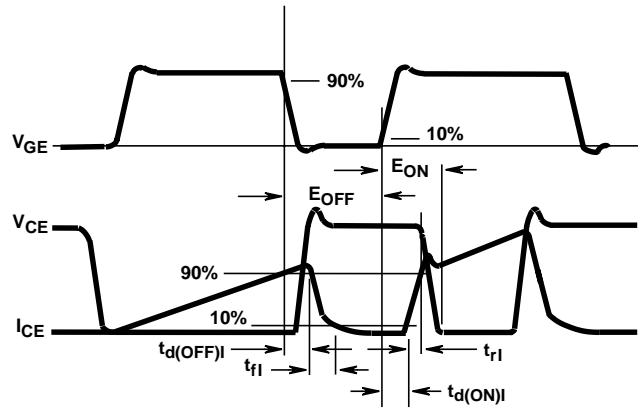

FIGURE 19. SWITCHING TEST WAVEFORMS

Handling Precautions for IGBT's

Insulated Gate Bipolar Transistors are susceptible to gate-insulation damage by the electrostatic discharge of energy through the devices. When handling these devices, care should be exercised to assure that the static charge built in the handler's body capacitance is not discharged through the device. With proper handling and application procedures, however, IGBTs are currently being extensively used in production by numerous equipment manufacturers in military, industrial and consumer applications, with virtually no damage problems due to electrostatic discharge. IGBTs can be handled safely if the following basic precautions are taken:

1. Prior to assembly into a circuit, all leads should be kept shorted together either by the use of metal shorting springs or by the insertion into conductive material such as "ECCOSORBD LD26™" or equivalent.
2. When devices are removed by hand from their carriers, the hand being used should be grounded by any suitable means - for example, with a metallic wristband.
3. Tips of soldering irons should be grounded.
4. Devices should never be inserted into or removed from circuits with power on.
5. **Gate Voltage Rating** - Never exceed the gate-voltage rating of V_{GEM} . Exceeding the rated V_{GE} can result in permanent damage to the oxide layer in the gate region.
6. **Gate Termination** - The gates of these devices are essentially capacitors. Circuits that leave the gate open-circuited or floating should be avoided. These conditions can result in turn-on of the device due to voltage buildup on the input capacitor due to leakage currents or pickup.
7. **Gate Protection** - These devices do not have an internal monolithic zener diode from gate to emitter. If gate protection is required an external zener is recommended.

Operating Frequency Information

Operating frequency information for a typical device (Figure 13) is presented as a guide for estimating device performance for a specific application. Other typical frequency vs collector current (I_{CE}) plots are possible using the information shown for a typical unit in Figures 4, 7, 8, 11 and 12. The operating frequency plot (Figure 13) of a typical device shows f_{MAX1} or f_{MAX2} whichever is smaller at each point. The information is based on measurements of a typical device and is bounded by the maximum rated junction temperature.

f_{MAX1} is defined by $f_{MAX1} = 0.05 / (t_{d(OFF)} + t_{d(ON)})$. Dead-time (the denominator) has been arbitrarily held to 10% of the on-state time for a 50% duty factor. Other definitions are possible. $t_{d(OFF)}$ and $t_{d(ON)}$ are defined in Figure 19. Device turn-off delay can establish an additional frequency limiting condition for an application other than T_{JMAX} . $t_{d(OFF)}$ is important when controlling output ripple under a lightly loaded condition.

f_{MAX2} is defined by $f_{MAX2} = (P_D - P_C) / (E_{OFF} + E_{ON})$. The allowable dissipation (P_D) is defined by $P_D = (T_{JMAX} - T_C) / R_{\theta JC}$. The sum of device switching and conduction losses must not exceed P_D . A 50% duty factor was used (Figure 13) and the conduction losses (P_C) are approximated by $P_C = (V_{CE} \times I_{CE}) / 2$.

E_{ON} and E_{OFF} are defined in the switching waveforms shown in Figure 19. E_{ON} is the integral of the instantaneous power loss ($I_{CE} \times V_{CE}$) during turn-on and E_{OFF} is the integral of the instantaneous power loss ($I_{CE} \times V_{CE}$) during turn-off. All tail losses are included in the calculation for E_{OFF} ; i.e. the collector current equals zero ($I_{CE} = 0$).

ECCOSORBD™ is a Trademark of Emerson and Cumming, Inc.

HGTG15N120C3, HGTP15N120C3, HGT1S15N120C3, HGT1S15N120C3S

TO-247

3 LEAD JEDEC STYLE TO-247 PLASTIC PACKAGE

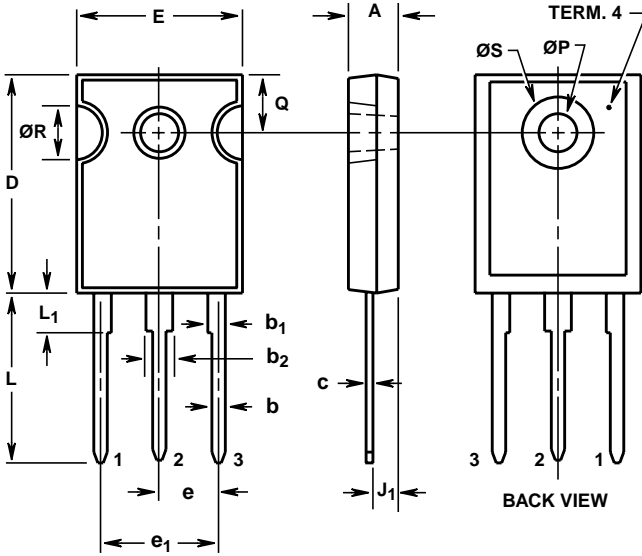

- LEAD NO. 1 - GATE
- LEAD NO. 2 - COLLECTOR
- LEAD NO. 3 - EMITTER
- TERM. 4 - COLLECTOR MOUNTING FLANGE

SYMBOL	INCHES		MILLIMETERS		NOTES
	MIN	MAX	MIN	MAX	
A	0.180	0.190	4.58	4.82	-
b	0.046	0.051	1.17	1.29	2, 3
b ₁	0.060	0.070	1.53	1.77	1, 2
b ₂	0.095	0.105	2.42	2.66	1, 2
c	0.020	0.026	0.51	0.66	1, 2, 3
D	0.800	0.820	20.32	20.82	-
E	0.605	0.625	15.37	15.87	-
e	0.219 TYP		5.56 TYP		4
e ₁	0.438 BSC		11.12 BSC		4
J ₁	0.090	0.105	2.29	2.66	5
L	0.620	0.640	15.75	16.25	-
L ₁	0.145	0.155	3.69	3.93	1
ØP	0.138	0.144	3.51	3.65	-
Q	0.210	0.220	5.34	5.58	-
ØR	0.195	0.205	4.96	5.20	-
ØS	0.260	0.270	6.61	6.85	-

NOTES:

1. Lead dimension and finish uncontrolled in L₁.
2. Lead dimension (without solder).
3. Add typically 0.002 inches (0.05mm) for solder coating.
4. Position of lead to be measured 0.250 inches (6.35mm) from bottom of dimension D.
5. Position of lead to be measured 0.100 inches (2.54mm) from bottom of dimension D.
6. Controlling dimension: Inch.
7. Revision 1 dated 1-93.

HGTG15N120C3, HGTP15N120C3, HGT1S15N120C3, HGT1S15N120C3S

TO-220AB (Alternate Version)

3 LEAD JEDEC TO-220AB PLASTIC PACKAGE

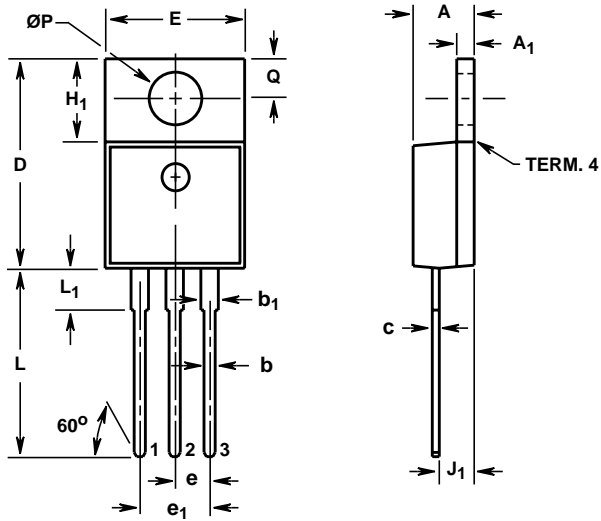

- LEAD NO. 1 - GATE
- LEAD NO. 2 - COLLECTOR
- LEAD NO. 3 - EMITTER
- TERM. 4 - COLLECTOR

SYMBOL	INCHES		MILLIMETERS		NOTES
	MIN	MAX	MIN	MAX	
A	0.170	0.180	4.32	4.57	-
A ₁	0.048	0.052	1.22	1.32	2, 4
b	0.030	0.034	0.77	0.86	2, 4
b ₁	0.045	0.055	1.15	1.39	2, 4
c	0.018	0.022	0.46	0.55	2, 4
D	0.590	0.610	14.99	15.49	-
E	0.395	0.405	10.04	10.28	-
e	0.100 TYP		2.54 TYP		5
e ₁	0.200 BSC		5.08 BSC		5
H ₁	0.235	0.255	5.97	6.47	-
J ₁	0.095	0.105	2.42	2.66	6
L	0.530	0.550	13.47	13.97	-
L ₁	0.110	0.130	2.80	3.30	3
ØP	0.149	0.153	3.79	3.88	-
Q	0.105	0.115	2.66	2.92	-

NOTES:

1. These dimensions are within allowable dimensions of Rev. J of JEDEC TO-220AB outline dated 3-24-87.
2. Dimension (without solder).
3. Solder finish uncontrolled in this area.
4. Add typically 0.002 inches (0.05mm) for solder plating.
5. Position of lead to be measured 0.250 inches (6.35mm) from bottom of dimension D.
6. Position of lead to be measured 0.100 inches (2.54mm) from bottom of dimension D.
7. Controlling dimension: Inch.
8. Revision 2 dated 10-95.

HGTG15N120C3, HGTP15N120C3, HGT1S15N120C3, HGT1S15N120C3S

TO-262AA

3 LEAD JEDEC TO-262AA PLASTIC PACKAGE

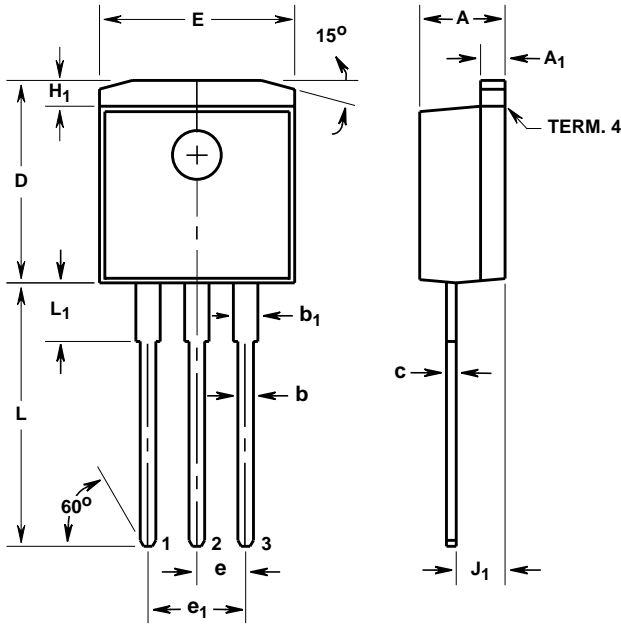

- LEAD NO. 1 - GATE
- LEAD NO. 2 - COLLECTOR
- LEAD NO. 3 - EMITTER
- TERM. 4 - COLLECTOR

SYMBOL	INCHES		MILLIMETERS		NOTES
	MIN	MAX	MIN	MAX	
A	0.170	0.180	4.32	4.57	-
A ₁	0.048	0.052	1.22	1.32	3, 4
b	0.030	0.034	0.77	0.86	3, 4
b ₁	0.045	0.055	1.15	1.39	3, 4
c	0.018	0.022	0.46	0.55	3, 4
D	0.405	0.425	10.29	10.79	-
E	0.395	0.405	10.04	10.28	-
e	0.100 TYP		2.54 TYP		5
e ₁	0.200 BSC		5.08 BSC		5
H ₁	0.045	0.055	1.15	1.39	-
J ₁	0.095	0.105	2.42	2.66	6
L	0.530	0.550	13.47	13.97	-
L ₁	0.110	0.130	2.80	3.30	2

NOTES:

1. These dimensions are within allowable dimensions of Rev. A of JEDEC TO-262AA outline dated 6-90.
2. Solder finish uncontrolled in this area.
3. Dimension (without solder).
4. Add typically 0.002 inches (0.05mm) for solder plating.
5. Position of lead to be measured 0.250 inches (6.35mm) from bottom of dimension D.
6. Position of lead to be measured 0.100 inches (2.54mm) from bottom of dimension D.
7. Controlling dimension: Inch.
8. Revision 4 dated 10-95.

HGTG15N120C3, HGTP15N120C3, HGT1S15N120C3, HGT1S15N120C3S

TO-263AB

SURFACE MOUNT JEDEC TO-263AB PLASTIC PACKAGE

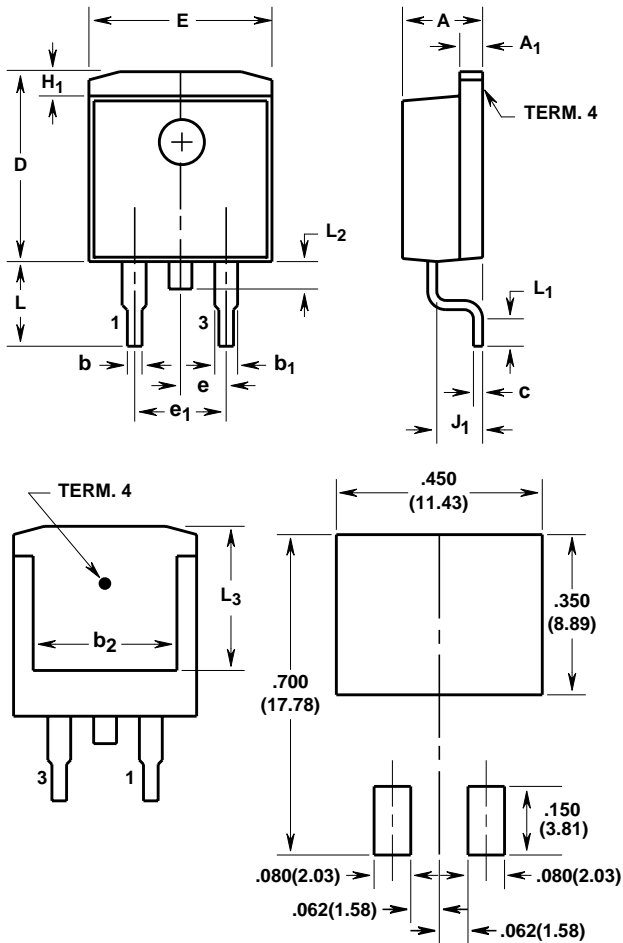

MINIMUM PAD SIZE RECOMMENDED FOR SURFACE-MOUNTED APPLICATIONS

- LEAD NO. 1 - GATE
- LEAD NO. 3 - EMITTER
- TERM. 4 - COLLECTOR

SYMBOL	INCHES		MILLIMETERS		NOTES
	MIN	MAX	MIN	MAX	
A	0.170	0.180	4.32	4.57	-
A ₁	0.048	0.052	1.22	1.32	4, 5
b	0.030	0.034	0.77	0.86	4, 5
b ₁	0.045	0.055	1.15	1.39	4, 5
b ₂	0.310	-	7.88	-	2
c	0.018	0.022	0.46	0.55	4, 5
D	0.405	0.425	10.29	10.79	-
E	0.395	0.405	10.04	10.28	-
e	0.100 TYP		2.54 TYP		7
e ₁	0.200 BSC		5.08 BSC		7
H ₁	0.045	0.055	1.15	1.39	-
J ₁	0.095	0.105	2.42	2.66	-
L	0.175	0.195	4.45	4.95	-
L ₁	0.090	0.110	2.29	2.79	4, 6
L ₂	0.050	0.070	1.27	1.77	3
L ₃	0.315	-	8.01	-	2

NOTES:

1. These dimensions are within allowable dimensions of Rev. C of JEDEC TO-263AB outline dated 2-92.
2. L₃ and b₂ dimensions established a minimum mounting surface for terminal 4.
3. Solder finish uncontrolled in this area.
4. Dimension (without solder).
5. Add typically 0.002 inches (0.05mm) for solder plating.
6. L₁ is the terminal length for soldering.
7. Position of lead to be measured 0.120 inches (3.05mm) from bottom of dimension D.
8. Controlling dimension: Inch.
9. Revision 7 dated 10-95.

HGTG15N120C3, HGTP15N120C3, HGT1S15N120C3, HGT1S15N120C3S

TO-263AB

24mm TAPE AND REEL

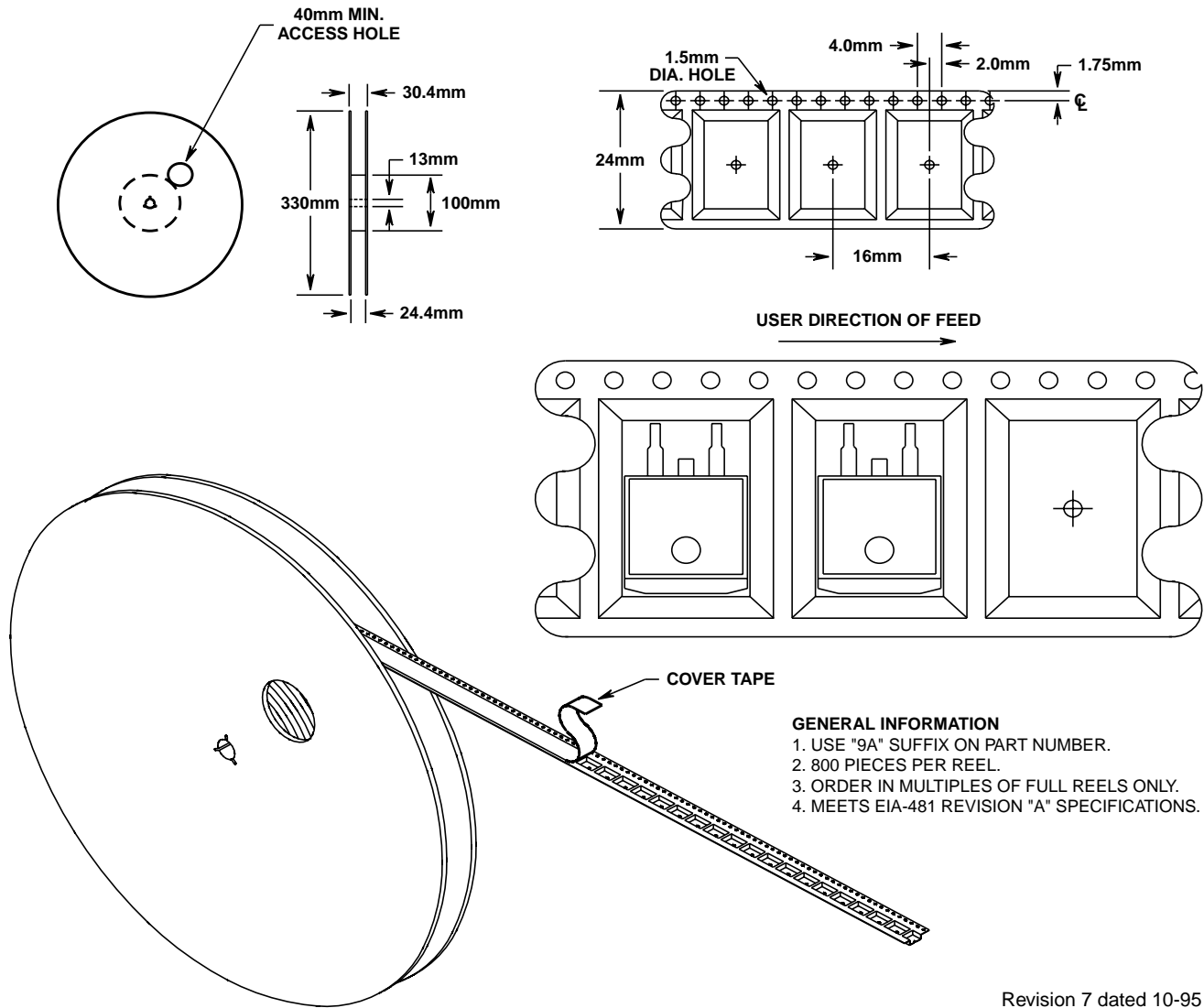

Revision 7 dated 10-95

All Intersil semiconductor products are manufactured, assembled and tested under **ISO9000** quality systems certification.

Intersil products are sold by description only. Intersil Corporation reserves the right to make changes in circuit design and/or specifications at any time without notice. Accordingly, the reader is cautioned to verify that data sheets are current before placing orders. Information furnished by Intersil is believed to be accurate and reliable. However, no responsibility is assumed by Intersil or its subsidiaries for its use; nor for any infringements of patents or other rights of third parties which may result from its use. No license is granted by implication or otherwise under any patent or patent rights of Intersil or its subsidiaries.

For information regarding Intersil Corporation and its products, see web site <http://www.intersil.com>

Sales Office Headquarters

NORTH AMERICA

Intersil Corporation
P. O. Box 883, Mail Stop 53-204
Melbourne, FL 32902
TEL: (407) 724-7000
FAX: (407) 724-7240

EUROPE

Intersil SA
Mercure Center
100, Rue de la Fusee
1130 Brussels, Belgium
TEL: (32) 2.724.2111
FAX: (32) 2.724.22.05

ASIA

Intersil (Taiwan) Ltd.
Taiwan Limited
7F-6, No. 101 Fu Hsing North Road
Taipei, Taiwan
Republic of China
TEL: (886) 2 2716 9310
FAX: (886) 2 2715 3029