

1550 nm Laser in Coaxial Package with SM-Pigtail, Medium Power

STM 81004X
STM 81005X

- Designed for application in fiber-optic networks
- Laser diode with Multi-Quantum Well structure
- Suitable for bit rates up to 1 Gbit/s
- Ternary photodiode at rear mirror for monitoring and control of radiant power
- Hermetically sealed subcomponent, similar to TO 18
- SM Pigtail with optional flange

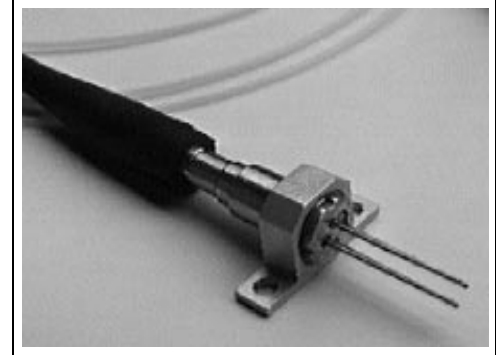

Type	Ordering Code	Connector/Flange
STM 81004G	Q62702-Pxxxx	FC / without flange
STM 81004A	Q62702-Pxxxx	DIN / without flange
STM 81005G	Q62702-Pxxxx	FC / with flange
STM 81005A	Q62702-Pxxxx	DIN / with flange

Component with other connector types on request.

Maximum Ratings

Output power ratings refer to the SM fiber output. The operating temperature of the submount is identical to the case temperature.

Parameter	Symbol	Values	Unit
-----------	--------	--------	------

Module

Operating temperature range at case	T_C	- 40 ... + 85	°C
Storage temperature range	T_{stg}	- 40 ... + 85	°C
Soldering temperature $t_{max} = 10$ s, 2 mm distance from bottom edge of case	T_S	260	°C

Maximum Ratings (cont'd)

Parameter	Symbol	Values	Unit
-----------	--------	--------	------

Laser Diode

Direct forward current	$I_{F \max}$	120	mA
Radiant power CW	Φ_e	2	mW
Reverse voltage	$V_{R \max}$	2	V

Monitor Diode

Reverse voltage	$V_{R \max}$	10	V
-----------------	--------------	----	---

Characteristics

All optical data refer to a coupled 10/125 μm SM fiber, $T_C = 25^\circ\text{C}$.

Parameter	Symbol	Values	Unit
-----------	--------	--------	------

Laser Diode

Optical output power	Φ_e	> 1.2	mW
Emission wavelength center of range $\Phi_e = 0.5 \text{ mW}$	λ	1510 ... 1590	nm
Spectral bandwidth $\Phi_e = 0.5 \text{ mW}$ (RMS)	$\Delta\lambda$	< 5	nm
Threshold current ($-40 \dots +85^\circ\text{C}$)	I_{th}	8 ... 60	mA
Forward voltage $\Phi_e = 0.5 \text{ mW}$	V_F	< 1.5	V
Radiant power at threshold	Φ_{eth}	< 40	μW
Slope efficiency	η	20 ... 100	mW/A
Differential series resistance	r_S	< 8	Ω
Rise time/fall time	t_R, t_F	< 1	ns

Monitor Diode

Dark Current, $V_R = 5 \text{ V}, \Phi_e = 0$	I_R	< 500	nA
Photocurrent, $\Phi_e = 0.5 \text{ mW}$	I_P	100 ... 1000	μA

Laser Diode
Radiant Power in Singlemode Fiber

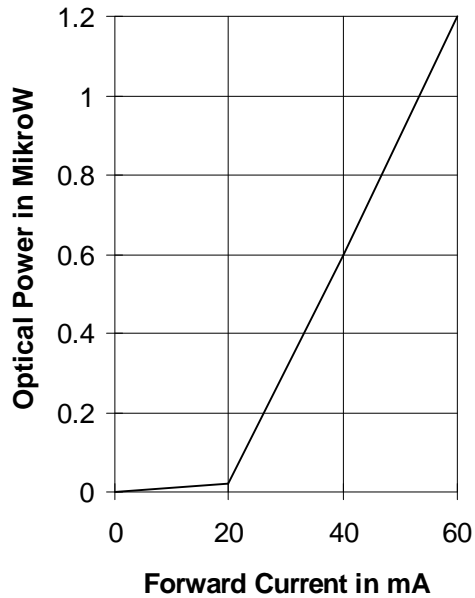

Relative Radiant Power
 $\Phi_e = f(\lambda)$

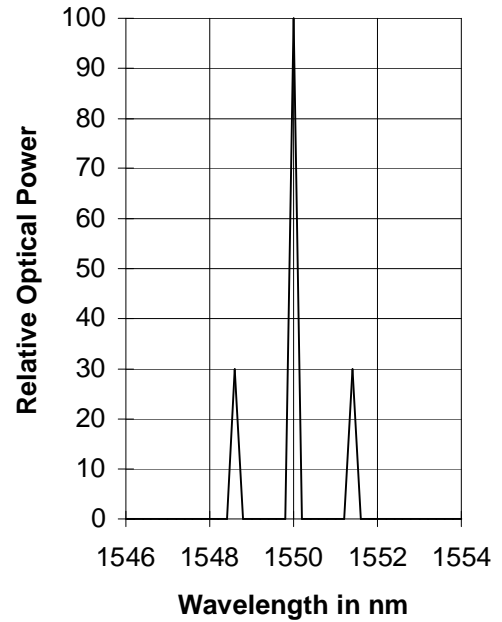

Laser Forward Current
 $I_F = f(V_F)$

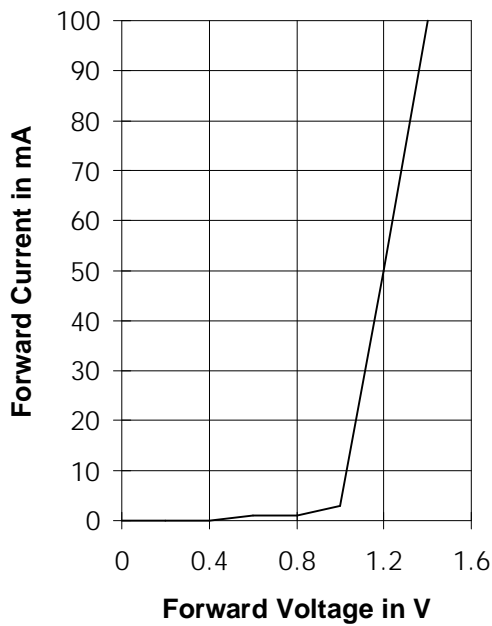

Monitor Diode Dark Current $I_R = f(T_A)$
 $\Phi_{port} = 0, V_R = 5 V$

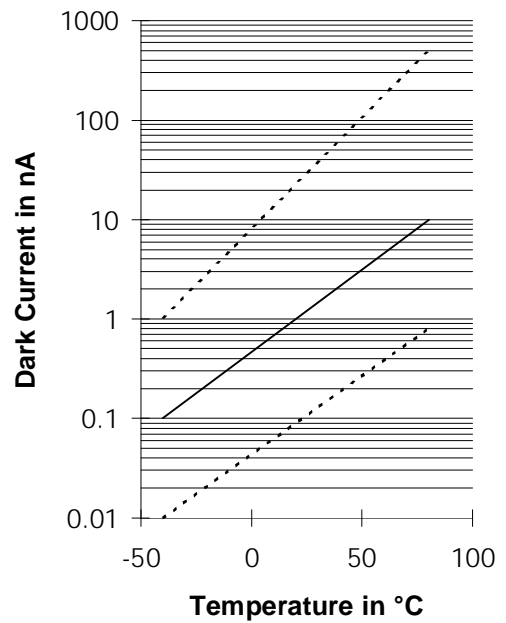

Package Outlines (Dimensions in mm)

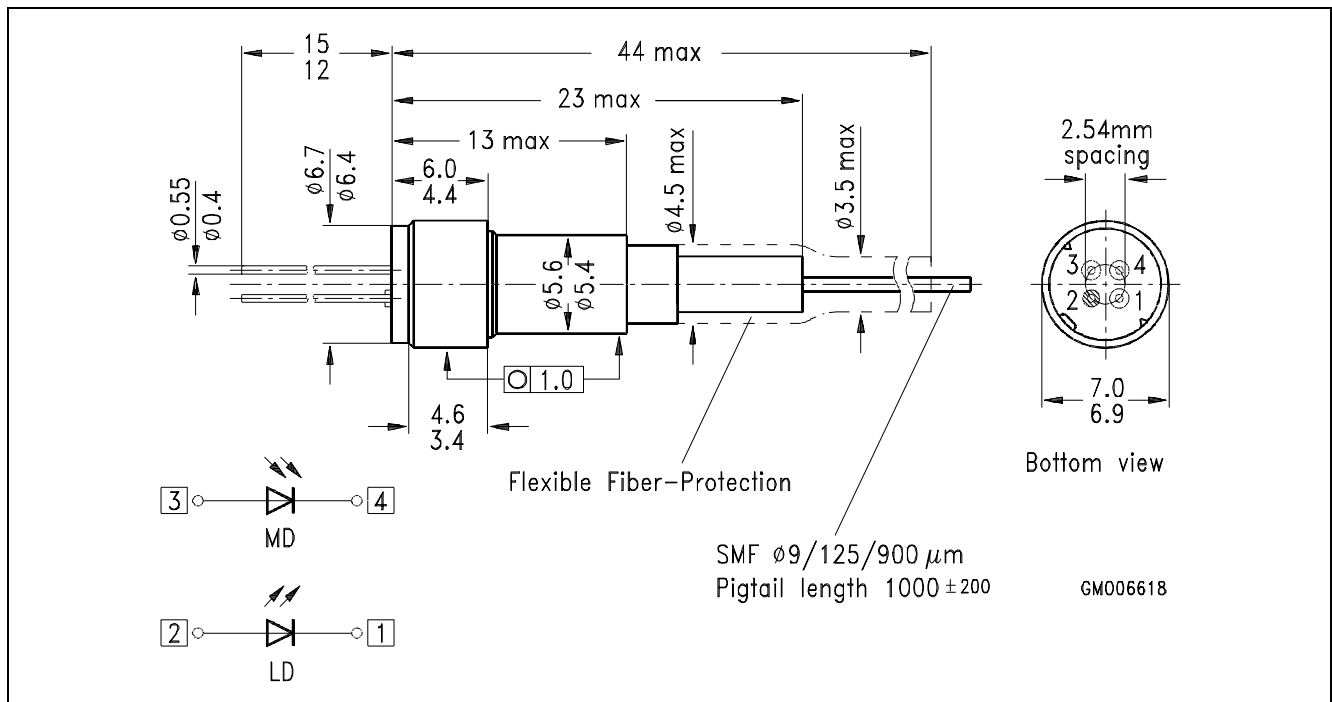

STM 81004X

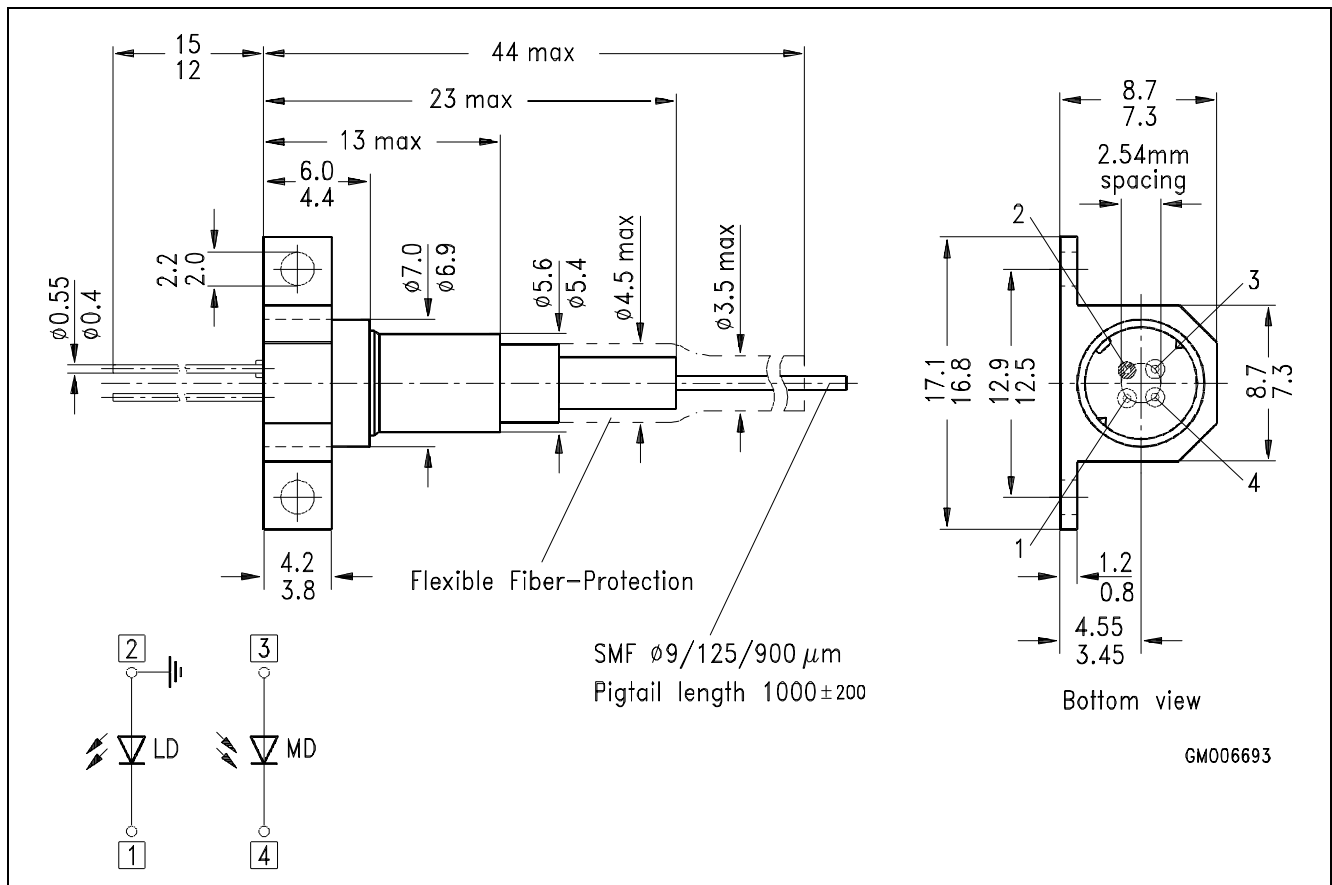

STM 81005X