

## N - CHANNEL ENHANCEMENT MODE POWER MOS TRANSISTOR

TYPE	V <sub>DSS</sub>	R <sub>DS(on)</sub>	I <sub>D</sub>
STP25N06	60 V	< 0.065 Ω	25 A
STP25N06FI	60 V	< 0.065 Ω	16 A

- TYPICAL R<sub>DS(on)</sub> = 0.048 Ω
- AVALANCHE RUGGED TECHNOLOGY
- 100% AVALANCHE TESTED
- REPETITIVE AVALANCHE DATA AT 100°C
- LOW GATE CHARGE
- HIGH CURRENT CAPABILITY
- 175°C OPERATING TEMPERATURE
- APPLICATION ORIENTED CHARACTERIZATION

### APPLICATIONS

- HIGH CURRENT, HIGH SPEED SWITCHING
- SOLENOID AND RELAY DRIVERS
- REGULATORS
- DC-DC & DC-AC CONVERTERS
- MOTOR CONTROL, AUDIO AMPLIFIERS
- AUTOMOTIVE ENVIRONMENT (INJECTION, ABS, AIR-BAG, LAMPDRIVERS, Etc.)



### ABSOLUTE MAXIMUM RATINGS

Symbol	Parameter	Value		Unit
		STP25N06	STP25N06FI	
V <sub>DS</sub>	Drain-source Voltage (V <sub>GS</sub> = 0)	60		V
V <sub>DGR</sub>	Drain- gate Voltage (R <sub>GS</sub> = 20 kΩ)	60		V
V <sub>GS</sub>	Gate-source Voltage	± 20		V
I <sub>D</sub>	Drain Current (continuous) at T <sub>c</sub> = 25 °C	25	16	A
I <sub>D</sub>	Drain Current (continuous) at T <sub>c</sub> = 100 °C	17	11	A
I <sub>DM</sub> (●)	Drain Current (pulsed)	100	100	A
P <sub>tot</sub>	Total Dissipation at T <sub>c</sub> = 25 °C	90	40	W
	Derating Factor	0.6	0.27	W/°C
V <sub>ISO</sub>	Insulation Withstand Voltage (DC)	—	2000	V
T <sub>stg</sub>	Storage Temperature	-65 to 175		°C
T <sub>j</sub>	Max. Operating Junction Temperature	175		°C

(●) Pulse width limited by safe operating area

## THERMAL DATA

		TO-220	ISOWATT220		
R <sub>thj-case</sub>	Thermal Resistance Junction-case	Max	1.57	3.75	°C/W
R <sub>thj-amb</sub>	Thermal Resistance Junction-ambient	Max	62.5		°C/W
R <sub>thc-sink</sub>	Thermal Resistance Case-sink	Typ	0.5		°C/W
T <sub>l</sub>	Maximum Lead Temperature For Soldering Purpose		300		°C

## AVALANCHE CHARACTERISTICS

Symbol	Parameter	Max Value	Unit
I <sub>AR</sub>	Avalanche Current, Repetitive or Not-Repetitive (pulse width limited by T <sub>j</sub> max, δ < 1%)	25	A
E <sub>AS</sub>	Single Pulse Avalanche Energy (starting T <sub>j</sub> = 25 °C, I <sub>D</sub> = I <sub>AR</sub> , V <sub>DD</sub> = 25 V)	100	mJ
E <sub>AR</sub>	Repetitive Avalanche Energy (pulse width limited by T <sub>j</sub> max, δ < 1%)	25	mJ
I <sub>AR</sub>	Avalanche Current, Repetitive or Not-Repetitive (T <sub>c</sub> = 100 °C, pulse width limited by T <sub>j</sub> max, δ < 1%)	17	A

ELECTRICAL CHARACTERISTICS (T<sub>case</sub> = 25 °C unless otherwise specified)

OFF

Symbol	Parameter	Test Conditions	Min.	Typ.	Max.	Unit
V <sub>(BR)DSS</sub>	Drain-source Breakdown Voltage	I <sub>D</sub> = 250 μA V <sub>GS</sub> = 0	60			V
I <sub>DSS</sub>	Zero Gate Voltage Drain Current (V <sub>GS</sub> = 0)	V <sub>DS</sub> = Max Rating V <sub>DS</sub> = Max Rating x 0.8 T <sub>c</sub> = 125 °C			1 10	μA μA
I <sub>GSS</sub>	Gate-body Leakage Current (V <sub>DS</sub> = 0)	V <sub>GS</sub> = ± 20 V			± 100	nA

ON (\*)

Symbol	Parameter	Test Conditions	Min.	Typ.	Max.	Unit
V <sub>GS(th)</sub>	Gate Threshold Voltage	V <sub>DS</sub> = V <sub>GS</sub> I <sub>D</sub> = 250 μA	2	2.9	4	V
R <sub>DS(on)</sub>	Static Drain-source On Resistance	V <sub>GS</sub> = 10V I <sub>D</sub> = 12.5 A		0.048	0.065	Ω
I <sub>D(on)</sub>	On State Drain Current	V <sub>DS</sub> > I <sub>D(on)</sub> x R <sub>DS(on)max</sub> V <sub>GS</sub> = 10 V	25			A

DYNAMIC

Symbol	Parameter	Test Conditions	Min.	Typ.	Max.	Unit
g <sub>fs</sub> (*)	Forward Transconductance	V <sub>DS</sub> > I <sub>D(on)</sub> x R <sub>DS(on)max</sub> I <sub>D</sub> = 12.5 A	7	11		S
C <sub>iss</sub>	Input Capacitance	V <sub>DS</sub> = 25 V f = 1 MHz V <sub>GS</sub> = 0		700	900	pF
C <sub>oss</sub>	Output Capacitance			320	450	pF
C <sub>rss</sub>	Reverse Transfer Capacitance			90	150	pF

**ELECTRICAL CHARACTERISTICS** (continued)

**SWITCHING ON**

Symbol	Parameter	Test Conditions	Min.	Typ.	Max.	Unit
$t_{d(on)}$ $t_r$	Turn-on Time Rise Time	$V_{DD} = 30\text{ V}$ $I_D = 3\text{ A}$ $R_G = 50\ \Omega$ $V_{GS} = 10\text{ V}$ (see test circuit, figure 3)		30 90	45 130	ns ns
$(di/dt)_{on}$	Turn-on Current Slope	$V_{DD} = 40\text{ V}$ $I_D = 25\text{ A}$ $R_G = 50\ \Omega$ $V_{GS} = 10\text{ V}$ (see test circuit, figure 5)		230		A/ $\mu$ s
$Q_g$ $Q_{gs}$ $Q_{gd}$	Total Gate Charge Gate-Source Charge Gate-Drain Charge	$V_{DD} = 40\text{ V}$ $I_D = 25\text{ A}$ $V_{GS} = 10\text{ V}$		26 8 9	40	nC nC nC

**SWITCHING OFF**

Symbol	Parameter	Test Conditions	Min.	Typ.	Max.	Unit
$t_{r(Voff)}$ $t_f$ $t_c$	Off-voltage Rise Time Fall Time Cross-over Time	$V_{DD} = 40\text{ V}$ $I_D = 25\text{ A}$ $R_G = 50\ \Omega$ $V_{GS} = 10\text{ V}$ (see test circuit, figure 5)		80 80 170	120 120 250	ns ns ns

**SOURCE DRAIN DIODE**

Symbol	Parameter	Test Conditions	Min.	Typ.	Max.	Unit
$I_{SD}$ $I_{SDM}(\bullet)$	Source-drain Current Source-drain Current (pulsed)				25 100	A A
$V_{SD} (*)$	Forward On Voltage	$I_{SD} = 25\text{ A}$ $V_{GS} = 0$			1.5	V
$t_{rr}$ $Q_{rr}$ $I_{RRM}$	Reverse Recovery Time Reverse Recovery Charge Reverse Recovery Current	$I_{SD} = 25\text{ A}$ $di/dt = 100\text{ A}/\mu\text{s}$ $V_{DD} = 30\text{ V}$ $T_j = 150\text{ }^\circ\text{C}$ (see test circuit, figure 5)		80 0.22 5.5		ns $\mu$ C A

(\*) Pulsed: Pulse duration = 300  $\mu$ s, duty cycle 1.5%

( $\bullet$ ) Pulse width limited by safe operating area

Safe Operating Areas For TO-220

Safe Operating Areas For ISOWATT220

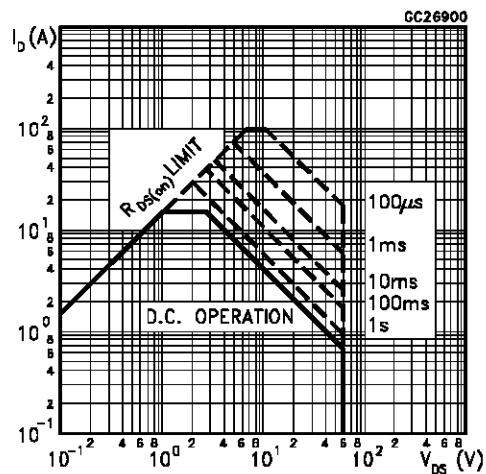
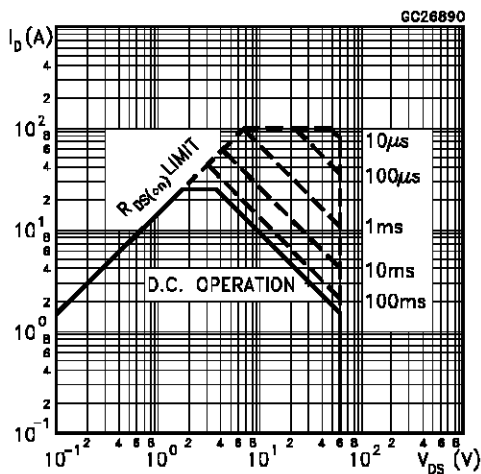

Thermal Impedance For TO-220

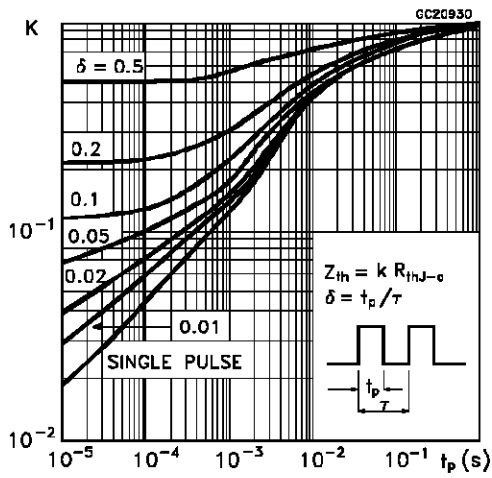

Thermal Impedance For ISOWATT220

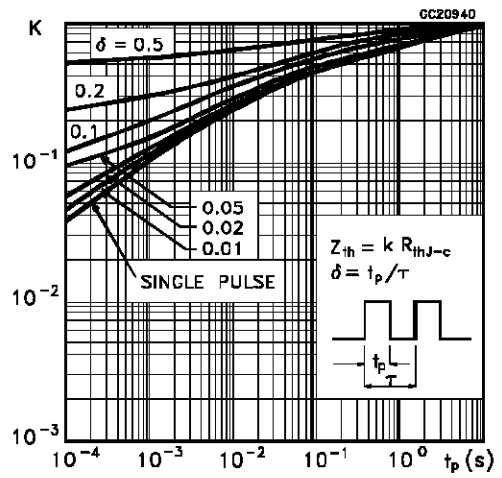

Derating Curve For TO-220

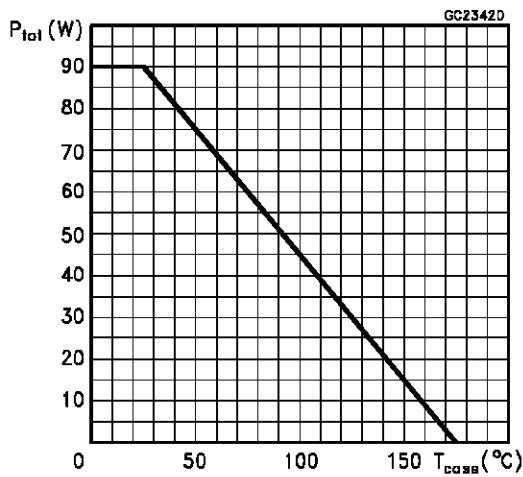

Derating Curve For ISOWATT220

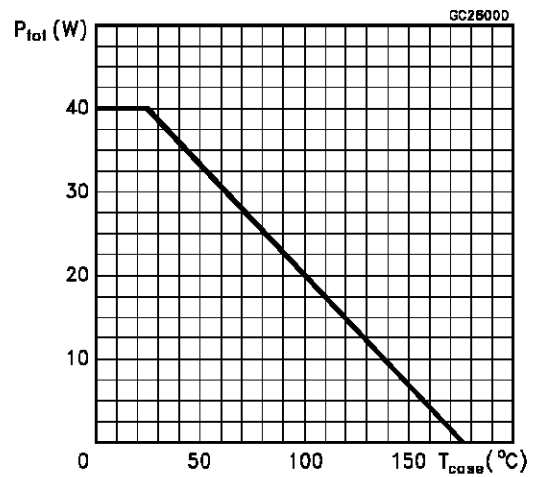

Output Characteristics

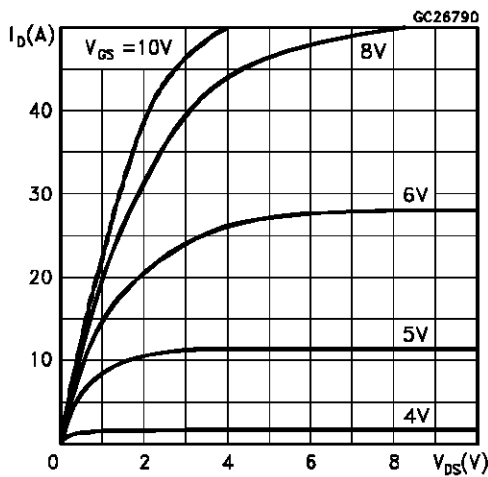

Transfer Characteristics

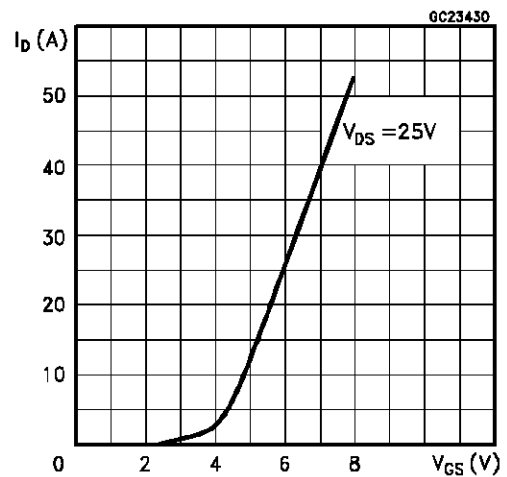

Transconductance

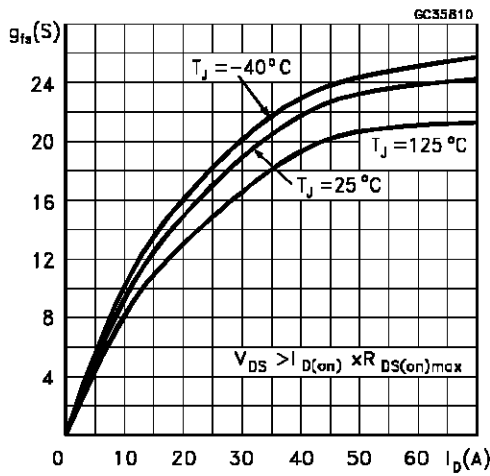

Static Drain-source On Resistance

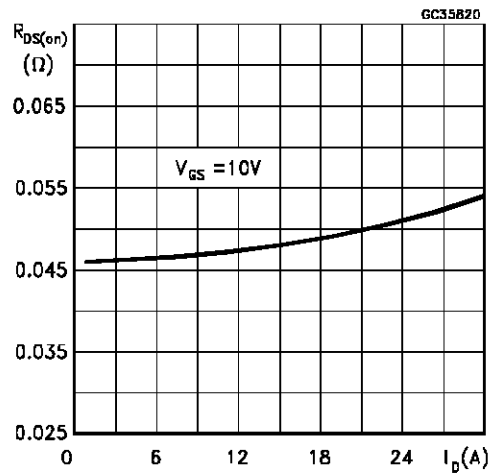

Gate Charge vs Gate-source Voltage

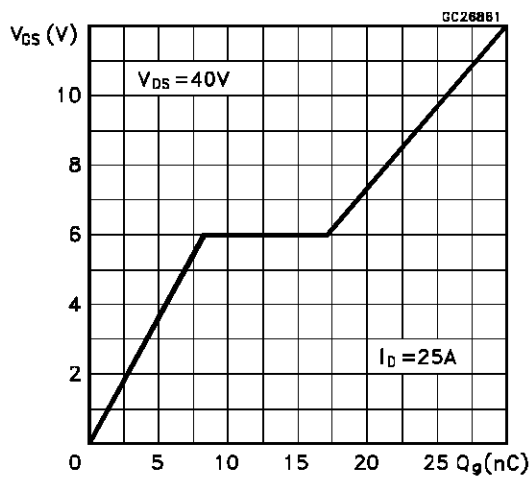

Capacitance Variations

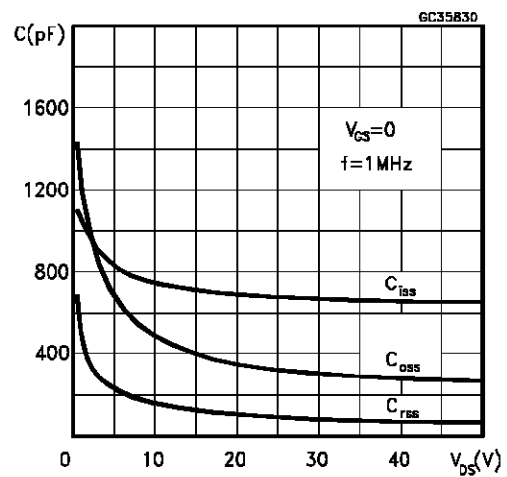

Normalized Gate Threshold Voltage vs Temperature

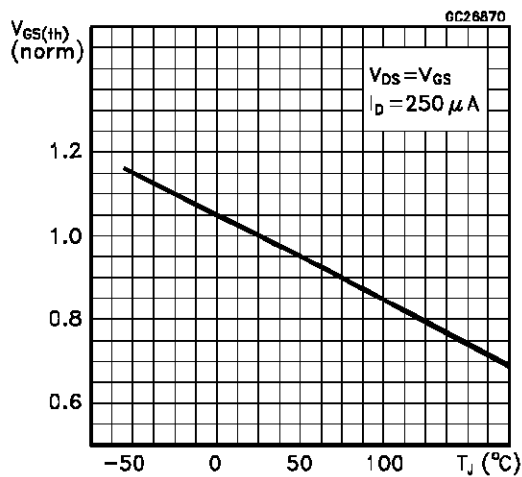

Normalized On Resistance vs Temperature

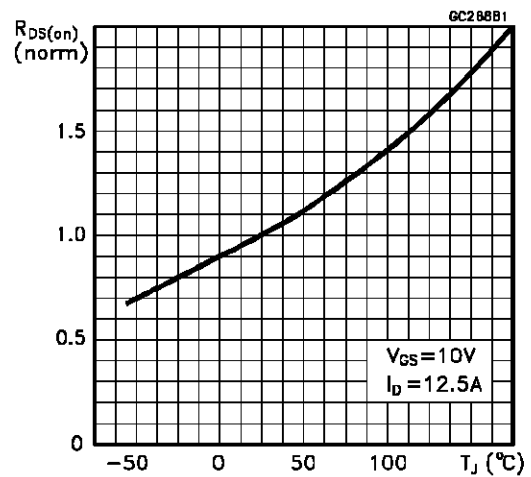

Turn-on Current Slope

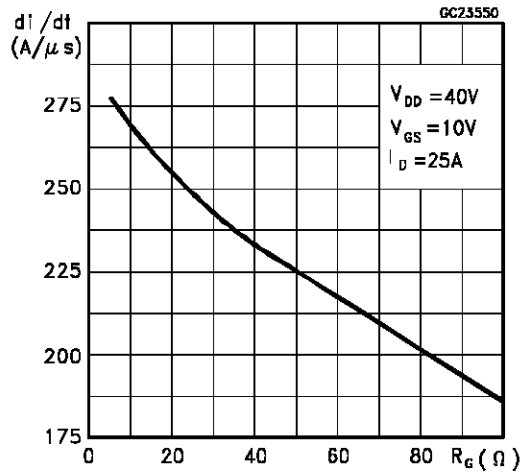

Turn-off Drain-source Voltage Slope

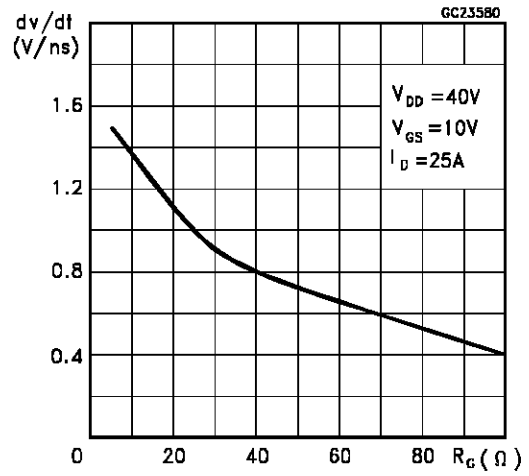

Cross-over Time

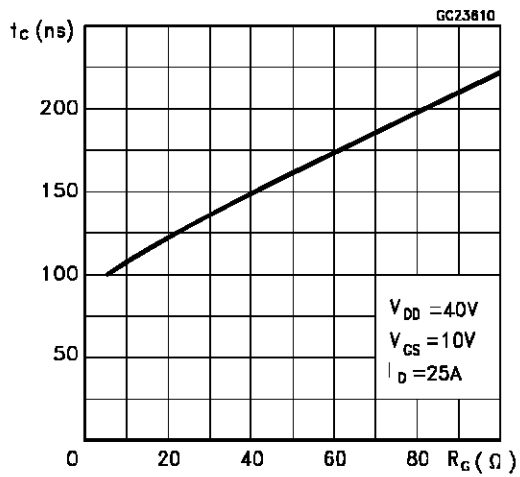

Switching Safe Operating Area

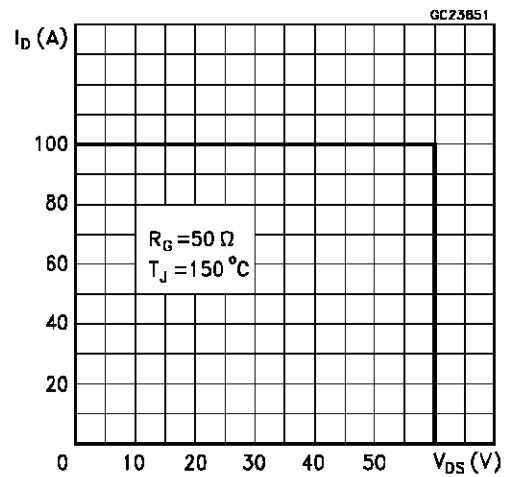

Accidental Overload Area

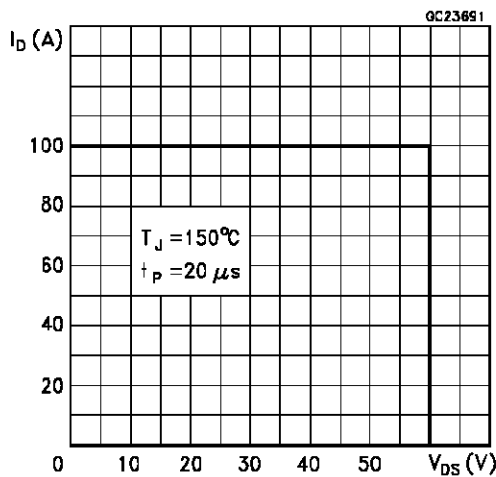

Source-drain Diode Forward Characteristics

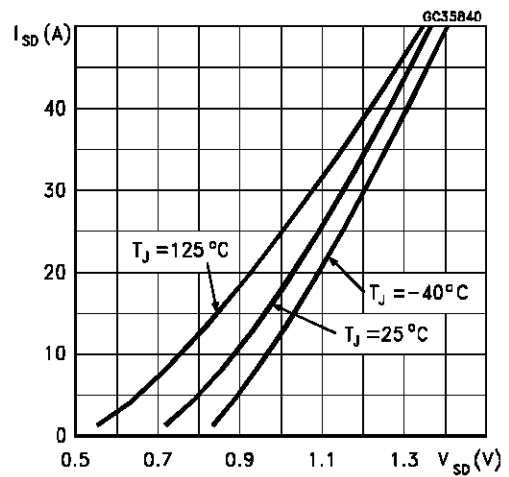

Fig. 1: Unclamped Inductive Load Test Circuits



Fig. 2: Unclamped Inductive Waveforms



Fig. 3: Switching Times Test Circuits For Resistive Load



Fig. 4: Gate Charge Test Circuit



Fig. 5: Test Circuit For Inductive Load Switching And Diode Reverse Recovery Time



**TO-220 MECHANICAL DATA**

DIM.	mm			inch		
	MIN.	TYP.	MAX.	MIN.	TYP.	MAX.
A	4.40		4.60	0.173		0.181
C	1.23		1.32	0.048		0.051
D	2.40		2.72	0.094		0.107
D1		1.27			0.050	
E	0.49		0.70	0.019		0.027
F	0.61		0.88	0.024		0.034
F1	1.14		1.70	0.044		0.067
F2	1.14		1.70	0.044		0.067
G	4.95		5.15	0.194		0.203
G1	2.4		2.7	0.094		0.106
H2	10.0		10.40	0.393		0.409
L2		16.4			0.645	
L4	13.0		14.0	0.511		0.551
L5	2.65		2.95	0.104		0.116
L6	15.25		15.75	0.600		0.620
L7	6.2		6.6	0.244		0.260
L9	3.5		3.93	0.137		0.154
DIA.	3.75		3.85	0.147		0.151





## ISOWATT220 MECHANICAL DATA

DIM.	mm			inch		
	MIN.	TYP.	MAX.	MIN.	TYP.	MAX.
A	4.4		4.6	0.173		0.181
B	2.5		2.7	0.098		0.106
D	2.5		2.75	0.098		0.108
E	0.4		0.7	0.015		0.027
F	0.75		1	0.030		0.039
F1	1.15		1.7	0.045		0.067
F2	1.15		1.7	0.045		0.067
G	4.95		5.2	0.195		0.204
G1	2.4		2.7	0.094		0.106
H	10		10.4	0.393		0.409
L2		16			0.630	
L3	28.6		30.6	1.126		1.204
L4	9.8		10.6	0.385		0.417
L6	15.9		16.4	0.626		0.645
L7	9		9.3	0.354		0.366
Ø	3		3.2	0.118		0.126



Information furnished is believed to be accurate and reliable. However, SGS-THOMSON Microelectronics assumes no responsibility for the consequences of use of such information nor for any infringement of patents or other rights of third parties which may result from its use. No license is granted by implication or otherwise under any patent or patent rights of SGS-THOMSON Microelectronics. Specifications mentioned in this publication are subject to change without notice. This publication supersedes and replaces all information previously supplied. SGS-THOMSON Microelectronics products are not authorized for use as critical components in life support devices or systems without express written approval of SGS-THOMSON Microelectronics.

© 1996 SGS-THOMSON Microelectronics - Printed in Italy - All Rights Reserved

SGS-THOMSON Microelectronics GROUP OF COMPANIES

Australia - Brazil - Canada - China - France - Germany - Hong Kong - Italy - Japan - Korea - Malaysia - Malta - Morocco - The Netherlands - Singapore - Spain - Sweden - Switzerland - Taiwan - Thailand - United Kingdom - U.S.A