

PTB 20235

70 Watts, 2.1–2.2 GHz

Wideband CDMA Power Transistor

Description

The 20235 is a class AB, NPN, push-pull RF power transistor intended for 26 Vdc operation from 2.1 to 2.2 GHz. Rated at 70 watts PEP minimum output power, it is specifically intended for operation as a final stage in Wide CDMA systems. Ion implantation, nitride surface passivation and gold metallization ensure excellent device reliability. 100% lot traceability is standard.

- 70 Watts, 2.1–2.2 GHz
- Class AB Characteristics
- Gold Metallization
- Silicon Nitride Passivated

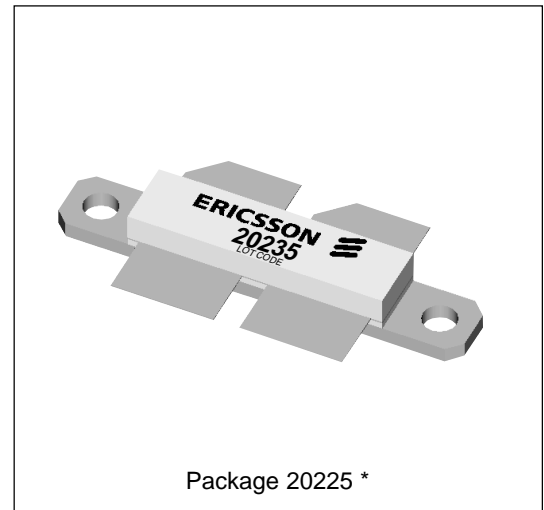
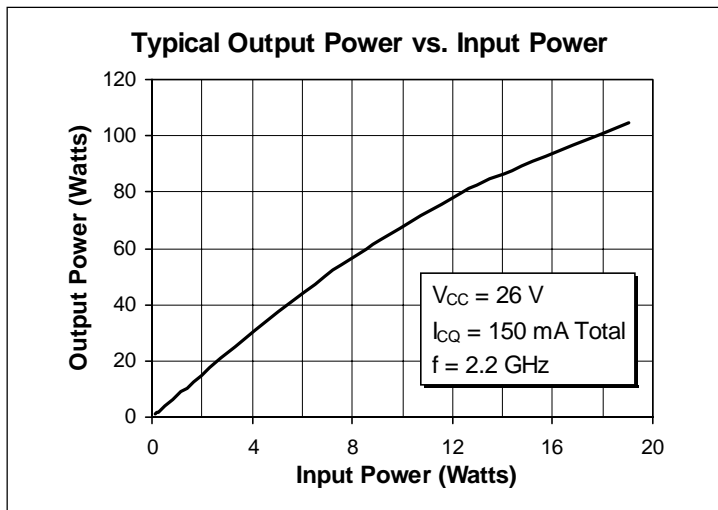

Maximum Ratings

Parameter	Symbol	Value	Unit
Collector-Emitter Voltage	V_{CER}	55	Vdc
Collector-Base Voltage	V_{CBO}	55	Vdc
Emitter-Base Voltage (collector open)	V_{EBO}	3.5	Vdc
Collector Current (continuous)	I_C	12	Adc
Total Device Dissipation at $T_{flange} = 25^\circ\text{C}$ Above 25°C derate by	P_D	320 1.83	Watts W/ $^\circ\text{C}$
Storage Temperature Range	T_{STG}	-40 to +150	$^\circ\text{C}$
Thermal Resistance ($T_{flange} = 70^\circ\text{C}$)	$R_{\theta JC}$	0.547	$^\circ\text{C/W}$

* This package not recommended for class A or CW operation. Two PTB 20245s recommended for CW operation.

Electrical Characteristics (100% Tested)

Characteristic	Conditions	Symbol	Min	Typ	Max	Units
Breakdown Voltage C to E	$V_{BE} = 0\text{ V}, I_C = 20\text{ mA}$	$V_{(BR)CES}$	55	—	—	Volts
Breakdown Voltage E to B	$I_C = 0\text{ A}, I_E = 20\text{ mA}$	$V_{(BR)EBO}$	3.5	4.0	—	Volts
DC Current Gain	$V_{CE} = 10\text{ V}, I_C = 1.5\text{ A}$	h_{FE}	30	50	120	—

RF Specifications (100% Tested)

Characteristic	Symbol	Min	Typ	Max	Units
Gain ($V_{CC} = 26\text{ Vdc}, P_{OUT} = 15\text{ W}, I_{CQ} = 150\text{ mA}, f = 2.2\text{ GHz}$)	G_{pe}	7.5	8.0	—	dB
Gain Compression ($V_{CC} = 26\text{ Vdc}, I_{CQ} = 150\text{ mA}, f = 2.2\text{ GHz}$)	P-1dB	70	—	—	Watts
Collector Efficiency ($V_{CC} = 26\text{ Vdc}, P_{OUT} = 70\text{ W}, I_{CQ} = 150\text{ mA}, f = 2.2\text{ GHz}$)	η_C	—	40	—	%
Load Mismatch Tolerance ($V_{CC} = 26\text{ Vdc}, P_{OUT} = 70\text{ W(PEP)}, I_{CQ} = 150\text{ mA}, f = 2.2\text{ GHz}$ —at all phase angles)	Ψ	—	—	5:1	—

Typical Performance

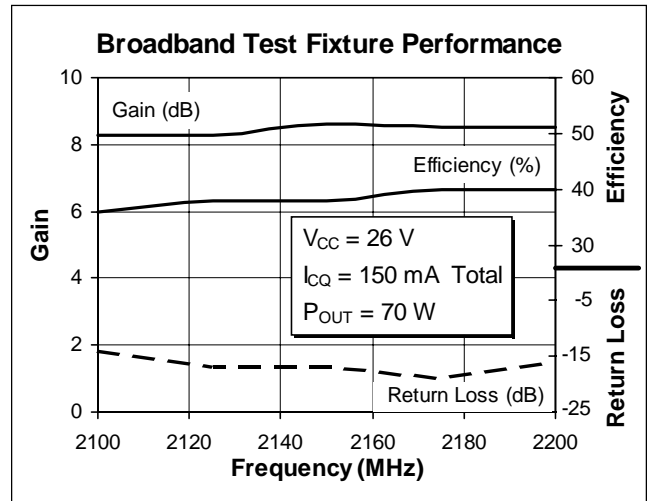
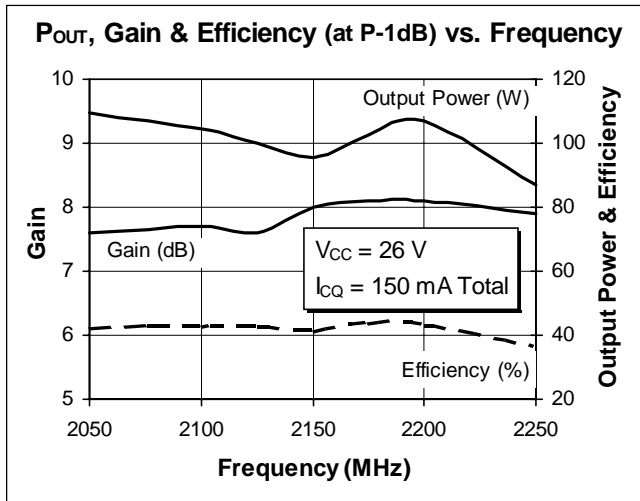

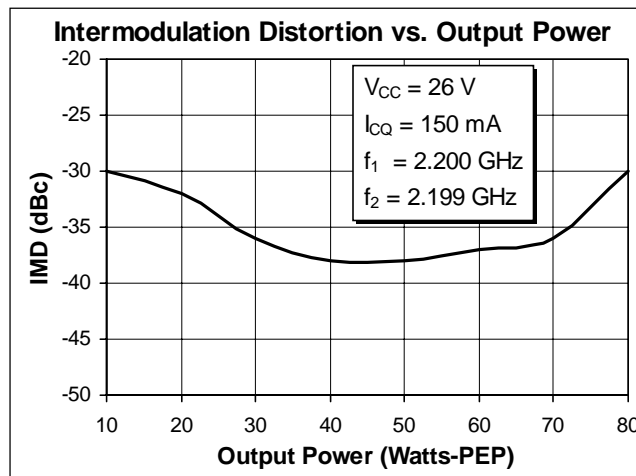
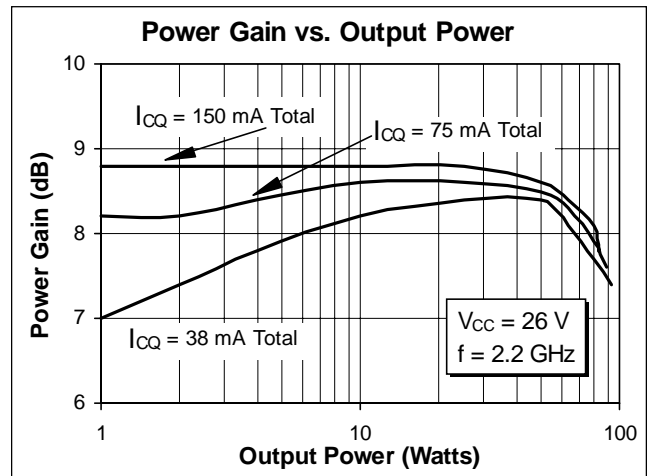
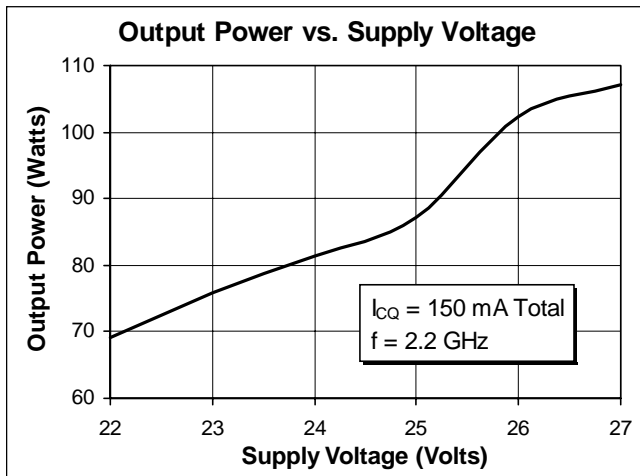

Impedance Data

$V_{CC} = 26 \text{ Vdc}$, $P_{OUT} = 70 \text{ W}$, $I_{CQ} = 150 \text{ mA}$

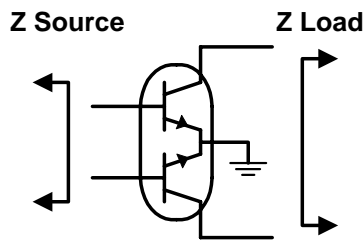

Frequency	Z Source		Z Load	
	R	jX	R	jX
2.05	6.18	-6.7	6.4	-5.8
2.10	7.58	-6.9	5.9	-5.0
2.15	8.76	-6.2	5.5	-4.1
2.20	9.16	-4.8	5.0	-3.0
2.25	7.96	-3.6	4.8	-2.6

Test Circuit

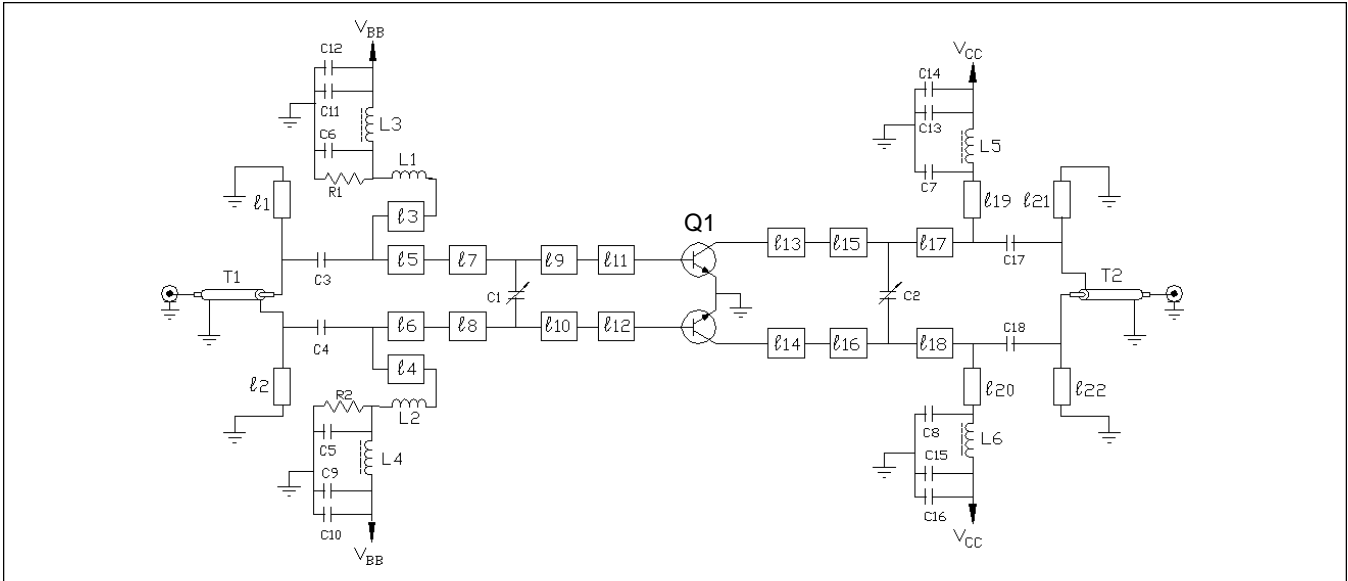

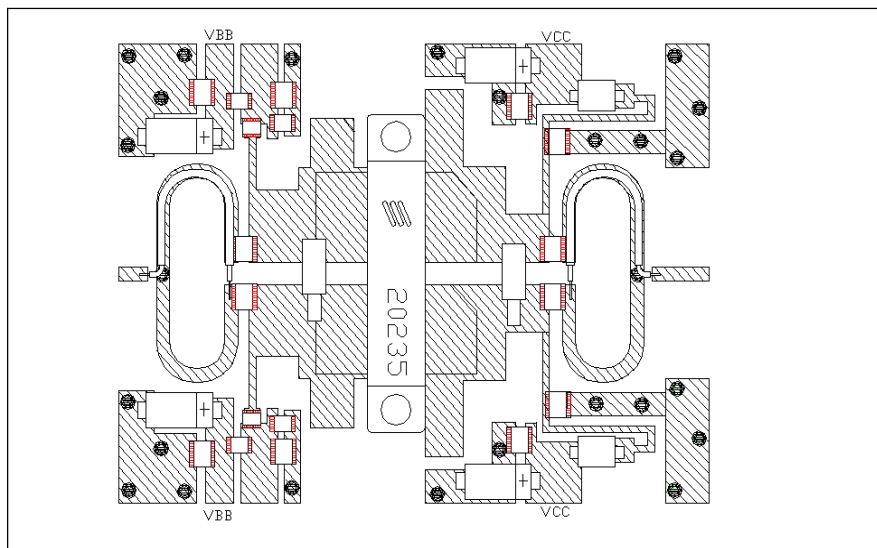

Block Diagram for $f = 2\text{ GHz}$

Q1	PTB 20235 NPN RF Transistor	L1, L2	6.8 nH SMT Inductor
l1, l2, l21, l22	0.25λ 2GHz Microstrip 50 Ω	L3, L4	56 nH SMT Inductor
l3, l4	0.085λ 2GHz Microstrip 80 Ω	L5, L6	4 mm. SMT Ferrite
l5, l6	0.067λ 2GHz Microstrip 20 Ω	C1, C2	0–4 pF Johanson Piston Trimmer
l7, l8, l11, l12	0.0217λ 2GHz Microstrip 11.7 Ω	C3-8, C17, C18	20 pF (B ATC 100)
l9, l10	0.053λ 2GHz Microstrip 8.15 Ω	C9, C11, C13, C15	0.1 μF 1206
l13, l14	0.055λ 2GHz Microstrip 6.7 Ω	C10, C12, C14, C16	10 μF SMT Tantalum
l15, l16	0.052λ 2GHz Microstrip 11.45 Ω	R1, R2	10 Ω SMT
l17, l18	0.060λ 2GHz Microstrip 16.9 Ω	T1, T2	UT 70-50
l19, l20	0.160λ 2GHz Microstrip 75 Ω	Board	0.031" G200, Solid Copper Bottom, AlliedSignal

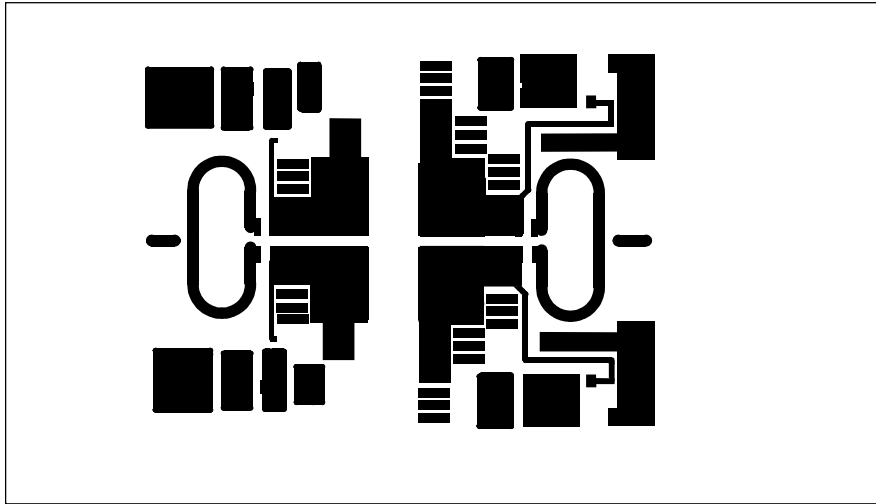

Placement Diagram (not to scale)



Artwork (1 inch )