

TOSHIBA CMOS DIGITAL INTEGRATED CIRCUIT SILICON MONOLITHIC

T6963C

DOT MATRIX LCD CONTROL LSI

The T6963C is an LCD controller designed to be used with LCD control driver LSIs and data display memories. The device has an 8-bit parallel data bus and control lines for reading or writing through an MPU interface. It can be directly connected to a TMPZ-80.

It has a 128-word character generator ROM which can control an external display RAM of up to 64 Kbytes. Allocation of text, graphics and external character generator RAM can be made easily and the display window can be moved freely within the allocated memory range.

The device supports a very broad range of LCD formats by allowing selection of different combinations via a set of programmable inputs. It can be used in text, graphic and combination text-and-graphic modes, and includes various attribute functions.

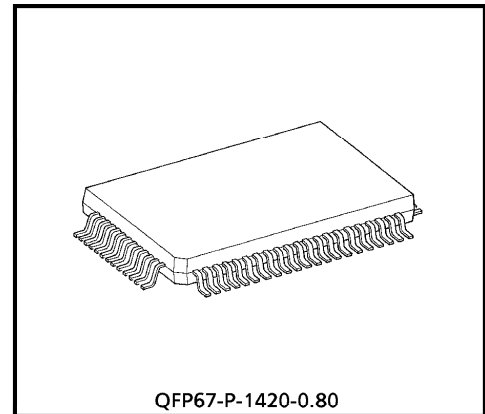

QFP67-P-1420-0.80

Weight: 1.2g (typ.)

FEATURES

- Display format (pin-selectable)

Columns : 32, 40, 64, 80

Lines : 2, 4, 6, 8, 10, 12, 14, 16, 20, 24, 28, 32

The combination of number of columns and number of lines must not cause the frequency to exceed 5.5 MHz. (See Fig. 2)

- Character font (pin-selectable)

Horizontal dots: 5, 6, 7, 8

Vertical dots : 8 (fixed)

It is necessary to set a character font in Graphic mode just as in Text mode. The oscillation frequency does not change with the font selection.

- Display duty : 1/16 to 1/128
- A 128-word character generator ROM (code 0101) T6963C-0101 is built in as standard.

980910EBA1

- TOSHIBA is continually working to improve the quality and the reliability of its products. Nevertheless, semiconductor devices in general can malfunction or fail due to their inherent electrical sensitivity and vulnerability to physical stress. It is the responsibility of the buyer, when utilizing TOSHIBA products, to observe standards of safety, and to avoid situations in which a malfunction or failure of a TOSHIBA product could cause loss of human life, bodily injury or damage to property. In developing your designs, please ensure that TOSHIBA products are used within specified operating ranges as set forth in the most recent products specifications. Also, please keep in mind the precautions and conditions set forth in the TOSHIBA Semiconductor Reliability Handbook.
- The products described in this document are subject to the foreign exchange and foreign trade laws.
- The information contained herein is presented only as a guide for the applications of our products. No responsibility is assumed by TOSHIBA CORPORATION for any infringements of intellectual property or other rights of the third parties which may result from its use. No license is granted by implication or otherwise under any intellectual property or other rights of TOSHIBA CORPORATION or others.
- The information contained herein is subject to change without notice.

- External display memory : 64 KB max
The addresses in display memory of the text area, graphic area and external character generator area are determined by software.
- Read or Write operations from the CPU do not disturb the display.
- A crystal oscillator circuit is built in. The oscillation frequency is adjusted according to the display size. If using an external clock, use the XI pin as the clock input. (XO open.)
External capacitors Crystal oscillation : 20 to 30 pF
Ceramic oscillation : 30 to 100 pF
Built-in feedback resistor : 900 kΩ (typ.)
- Toshiba LCD driver LSIs (other than these with a built-in RAM) can be connected to the device.
- External display RAM must be static RAM. The T6963C cannot refresh D-RAM.
- The attribute functions can only be used in Text mode. They cannot be used in Graphic or Combination Character mode.

BLOCK DIAGRAM

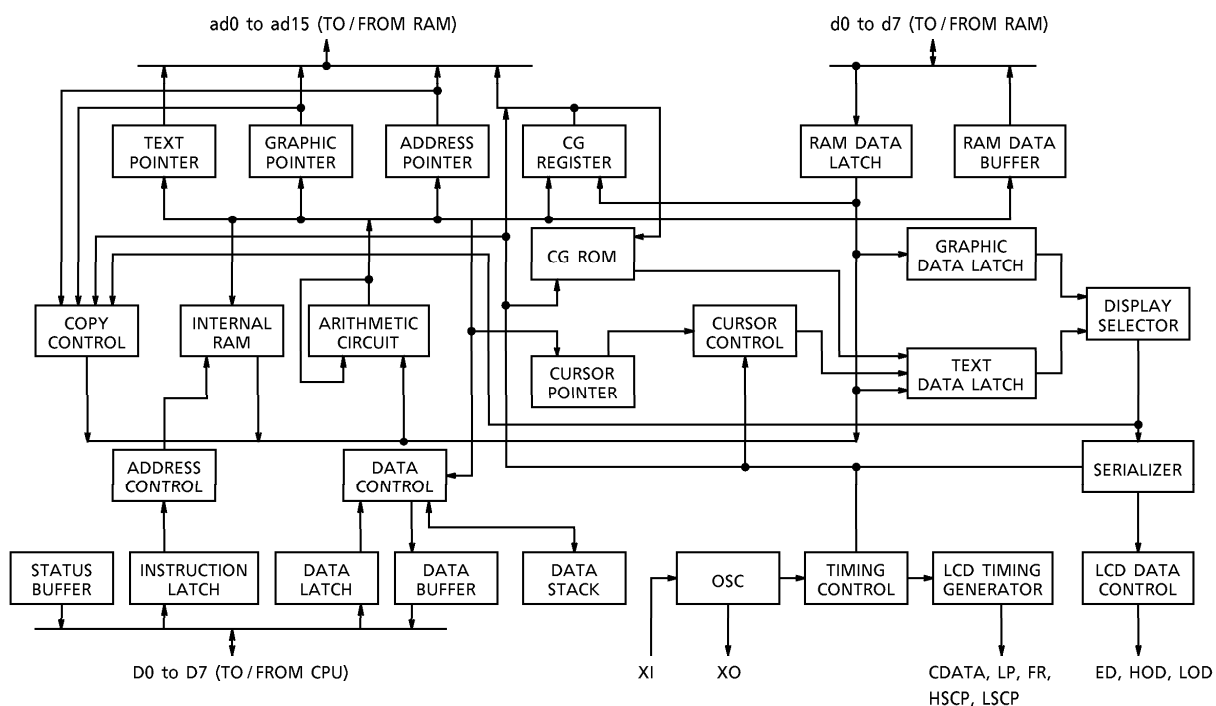

PIN ASSIGNMENT

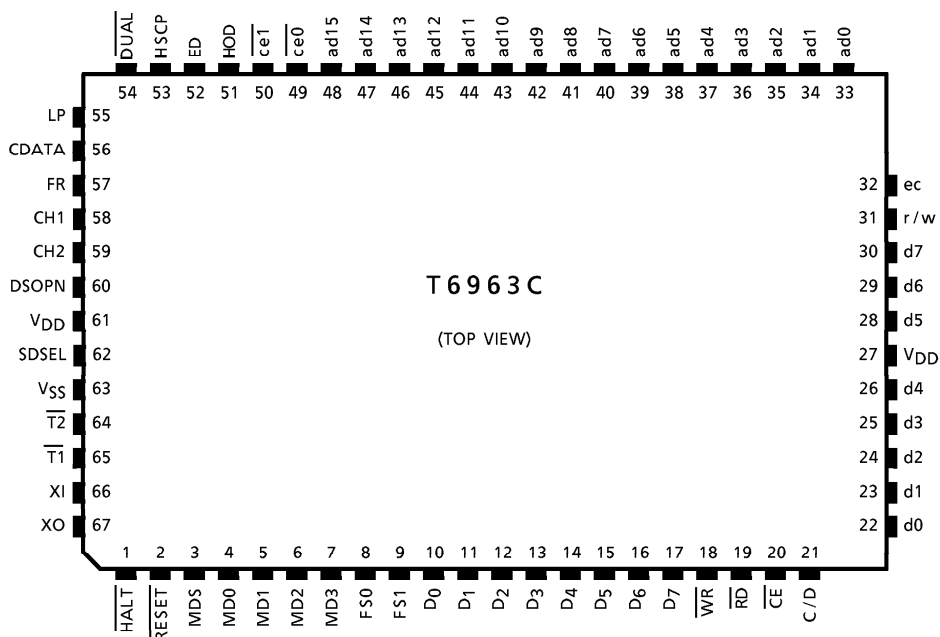

PIN FUNCTIONS

PIN NAME	I/O	FUNCTIONS																																																																																																																								
MDS MD0 MD1	Input	Pins for selection of LCD size																																																																																																																								
		<table border="1"> <tr> <td>DUAL</td> <td>H</td> <td>H</td> <td>H</td> <td>H</td> <td>H</td> <td>H</td> <td>H</td> <td>H</td> <td>L</td> <td>L</td> <td>L</td> <td>L</td> <td>L</td> <td>L</td> <td>L</td> <td>L</td> </tr> <tr> <td>MDS</td> <td>L</td> <td>L</td> <td>L</td> <td>L</td> <td>H</td> <td>H</td> <td>H</td> <td>H</td> <td>L</td> <td>L</td> <td>L</td> <td>L</td> <td>H</td> <td>H</td> <td>H</td> <td>H</td> </tr> <tr> <td>MD1</td> <td>H</td> <td>H</td> <td>L</td> <td>L</td> <td>H</td> <td>H</td> <td>L</td> <td>L</td> <td>H</td> <td>H</td> <td>L</td> <td>L</td> <td>H</td> <td>H</td> <td>L</td> <td>L</td> </tr> <tr> <td>MD0</td> <td>H</td> <td>L</td> <td>H</td> <td>L</td> <td>H</td> <td>L</td> <td>H</td> <td>L</td> <td>H</td> <td>L</td> <td>H</td> <td>L</td> <td>H</td> <td>L</td> <td>H</td> <td>L</td> </tr> <tr> <td>LINES</td> <td>2</td> <td>4</td> <td>6</td> <td>8</td> <td>10</td> <td>12</td> <td>14</td> <td>16</td> <td>4</td> <td>8</td> <td>12</td> <td>16</td> <td>20</td> <td>24</td> <td>28</td> <td>32</td> </tr> <tr> <td>V-DOTS</td> <td>16</td> <td>32</td> <td>48</td> <td>64</td> <td>80</td> <td>96</td> <td>112</td> <td>128</td> <td>32</td> <td>64</td> <td>96</td> <td>128</td> <td>160</td> <td>192</td> <td>224</td> <td>256</td> </tr> <tr> <td></td> <td></td> <td colspan="8">1 SCREEN</td> <td colspan="8">2 SCREENS</td> </tr> </table>	DUAL	H	H	H	H	H	H	H	H	L	L	L	L	L	L	L	L	MDS	L	L	L	L	H	H	H	H	L	L	L	L	H	H	H	H	MD1	H	H	L	L	H	H	L	L	H	H	L	L	H	H	L	L	MD0	H	L	H	L	H	L	H	L	H	L	H	L	H	L	H	L	LINES	2	4	6	8	10	12	14	16	4	8	12	16	20	24	28	32	V-DOTS	16	32	48	64	80	96	112	128	32	64	96	128	160	192	224	256			1 SCREEN								2 SCREENS							
		DUAL	H	H	H	H	H	H	H	H	L	L	L	L	L	L	L	L																																																																																																								
		MDS	L	L	L	L	H	H	H	H	L	L	L	L	H	H	H	H																																																																																																								
		MD1	H	H	L	L	H	H	L	L	H	H	L	L	H	H	L	L																																																																																																								
		MD0	H	L	H	L	H	L	H	L	H	L	H	L	H	L	H	L																																																																																																								
LINES	2	4	6	8	10	12	14	16	4	8	12	16	20	24	28	32																																																																																																										
V-DOTS	16	32	48	64	80	96	112	128	32	64	96	128	160	192	224	256																																																																																																										
		1 SCREEN								2 SCREENS																																																																																																																
MD2 MD3	Input	Pins for selection of number of columns																																																																																																																								
		<table border="1"> <tr> <td>MD2</td> <td>H</td> <td>L</td> <td>H</td> <td>L</td> </tr> <tr> <td>MD3</td> <td>H</td> <td>H</td> <td>L</td> <td>L</td> </tr> <tr> <td>Columns</td> <td>32</td> <td>40</td> <td>64</td> <td>80</td> </tr> </table>	MD2	H	L	H	L	MD3	H	H	L	L	Columns	32	40	64	80																																																																																																									
		MD2	H	L	H	L																																																																																																																				
MD3	H	H	L	L																																																																																																																						
Columns	32	40	64	80																																																																																																																						
FS0 FS1	Input	Pins for selection of font																																																																																																																								
		<table border="1"> <tr> <td>FS0</td> <td>H</td> <td>L</td> <td>H</td> <td>L</td> </tr> <tr> <td>FS1</td> <td>H</td> <td>H</td> <td>L</td> <td>L</td> </tr> <tr> <td>Font</td> <td>5×8</td> <td>6×8</td> <td>7×8</td> <td>8×8</td> </tr> </table>	FS0	H	L	H	L	FS1	H	H	L	L	Font	5×8	6×8	7×8	8×8																																																																																																									
		FS0	H	L	H	L																																																																																																																				
FS1	H	H	L	L																																																																																																																						
Font	5×8	6×8	7×8	8×8																																																																																																																						
D0 to D7	I/O	Data I/O pins between CPU and T6963C (D7 is MSB)																																																																																																																								
WR	Input	Data Write. Write data into T6963C when WR = L.																																																																																																																								
RD	Input	Data Read. Read data from T6963C when RD = L.																																																																																																																								
CE	Input	Chip Enable for T6963C. CE must be L when CPU communicates with T6963C.																																																																																																																								

PIN NAME	I/O	FUNCTIONS										
C/D	Input	WR = L C/D = H : Command Write C/D = L : Data Write RD = L C/D = H : Status Read C/D = L : Data Read										
HALT	Input	H Normal, L Stops the oscillation of the clock										
RESET	Input	H Normal (T6963C has internal pull-up resistor) L Initialize T6963C. Text and graphic have addresses and text and graphic area settings are retained.										
DSPON	Output	Control pin for external DC/DC. DSPON is L when HALT is L or RESET is L. (When DSPON goes H, the column drivers are cleared.)										
DUAL	Input	H Single-Scan L Dual-Scan <table border="1" style="margin-left: auto; margin-right: auto;"> <tr> <td>DUAL</td> <td>H</td> <td>H</td> <td>L</td> <td>L</td> </tr> <tr> <td>SDSEL</td> <td>H</td> <td>L</td> <td>H</td> <td>L</td> </tr> </table>	DUAL	H	H	L	L	SDSEL	H	L	H	L
DUAL	H	H	L	L								
SDSEL	H	L	H	L								
SDSEL	Input	H Sending data by odd / even separation L Sending data by simple serial method <table border="1" style="margin-left: auto; margin-right: auto;"> <tr> <td>Upper screen</td> <td>HOD, ED</td> <td>ED</td> <td>HOD, ED</td> <td>ED</td> </tr> <tr> <td>Lower screen</td> <td>—</td> <td>—</td> <td>LOD, ED</td> <td>ED</td> </tr> </table>	Upper screen	HOD, ED	ED	HOD, ED	ED	Lower screen	—	—	LOD, ED	ED
Upper screen	HOD, ED	ED	HOD, ED	ED								
Lower screen	—	—	LOD, ED	ED								
ce0 (LOD)	Output	ce0 at DUAL = H Chip enable pin for display memory in the address range 0000H to 07FFH LOD at DUAL = L Serial data output for odd columns in lower area of LCD										
ce1 (LSCP)	Output	ce1 at DUAL = H Chip enable pin for display memory in the address range 0800H to 0FFFH LSCP at DUAL = L Shift clock pulse output for column drivers in lower area of LCD										
ce	Output	Chip enable pin for display memory of any address										
d0 to d7	I/O	Data I/O pins for display memory										
ad0 to ad15	Output	Address outputs for display memory (ad15 = L : for upper area of LCD, ad15 = H : for lower area of LCD)										
R/W	Output	Read/Write signal for display memory										
ED	Output	SDSEL = H : Data output for even columns in both upper and lower areas of LCD SDSEL = L : Data output for columns in both upper and lower areas of LCD										
HOD	Output	Data output for odd columns in upper area of LCD										
CDATA	Output	Synchronous signal for row driver										
HSCP	Output	Shift clock pulse for column driver of upper area of LCD										
LP	Output	Latch pulse for column driver. Shift clock pulse for row driver										
FR	Output	Frame signal										
XI	Input	Crystal oscillator input										
XO	Output	Crystal oscillator output										
CH1, CH2	Output	Check signal										
T1, T2	Input	Test input. Usually open										
VDD	—	Power supply (5.0V)										
VSS	—	Power supply (0V)										

FUNCTIONAL DEFINITION

- After power on, it is necessary to reset. $\overline{\text{RESET}}$ is kept L between 5 clocks up (oscillation clock).
- When $\overline{\text{HALT}} = \text{L}$, the oscillation stops. The power supply for the LCD must now be turned off, to protect the LCD from DC bias.
- The HALT function includes the RESET function.
- The column/line counter and display register are cleared by RESET. (Other registers are not cleared.) Disable the display using the clear-display register.
- The status must be checked before data or commands are sent. The MSB = 0 status check must be done in particular. There is a possibility of erroneous operation due to a hard interrupt.
- STA0 and STA1 must be checked at the same time. When a command is executed, data transmission errors may occur.
- The T6963C can only handle one byte per machine cycle (16 clocks). It is impossible to send more than two data in a machine cycle.
- When using a command with operand data, it is important to send the data first, and then execute the command.
- The character codes used by the T6963C are different from ASCII codes.

- State after RESET / HALT (Fig. 1)

TERMINAL	HALT	RESET
D0 to D7	F	F
d0 to d7	F	F
r/w	H	H
\overline{ce}	H (Note 1)	H (Note 1)
ad0 to ad15	H (Note 2)	H (Note 2)
$\overline{ce0}, \overline{ce1}$	H (Note 1)	H (Note 1)
ED, HOD	Final data	Final data
HSCP	L	L
LP	L	L
CDATA	H	H
FR	H	H
CH1	L	K0
CH2	L	VEND
DSPON	L	L
XO	H	OSC clock

H : Level H

L : Level L

F : Floating (high impedance)

K0 : Test signal

VEND : Test signal

(Note 1) : In Attribute mode, H or L according to state of graphic pointer

(Note 2) : In Attribute mode, data of graphic pointer

- The relationship between number of row/column and oscillation clock (Fig. 2)

The frequency of the crystal oscillator is adjusted by the following formula.

f_{OSC} : Frequency of oscillation

f_{SCP} : Frequency of shift clock ($f_{SCP} = f_{OSC} / 2$)

f_R : Frequency of Frame

M : Number of characters on one line (number of dots on one line = 8M)

For all font sizes (e.g. 7×8, 6×8, 5×8) the oscillation frequency remains constant.

N : Number of rows (duty = 1 / 8N)

$$\frac{8M}{f_{SCP}} \times 8N = \frac{1}{f_R}$$

$$f_{OSC} = f_R \times 64 \times 2 \times M \times N$$

($f_R = 60$ Hz)

UNIT: [MHz]

N \ M	32	40	64	80	duty
2	0.492	0.614	0.983	1.229	1 / 16
	0.983	1.229	1.966	2.458	
4	0.983	1.229	1.966	2.458	1 / 32
	1.966	2.458	3.932	4.915	
6	1.475	1.843	2.949	3.686	1 / 48
	2.949	3.686	5.898	7.372	
8	1.966	2.458	3.932	4.915	1 / 64
	3.932	4.915	7.864	9.830	
10	2.458	3.072	4.915	6.144	1 / 80
	4.915	6.144	9.830	12.288	
12	2.949	3.686	5.898	7.373	1 / 96
	5.898	7.373	11.776	14.746	
14	3.440	4.300	6.881	8.602	1 / 112
	6.881	8.601	13.763	17.203	
16	3.932	4.915	7.864	9.830	1 / 128
	7.864	9.830	15.729	19.660	

(Note 1) Upper ... Single-Scan, lower ... Dual-Scan at $f_R = 60$ Hz

Upper
Lower

- RAM Interface

The external RAM is used to store display data (text, graphic and external CG data).

With single-scan, text data, graphic data and external CG data can be freely allocated to the memory area (64 KB max).

With dual-scan, LCD I is allocated to 0000H to 7FFFH (32 KB max), LCDII is allocated to 8000H to FFFFH (32 KB max). Text data, graphic data and external CG data can be freely allocated in LCD I . In LCDII, the same addresses must be allocated as in LCD I , except ad15. ad15 determines selection of LCD I or LCDII .

It can be use the address decoded signals $\overline{ce0}$ (0000 to 07FFFH), $\overline{ce1}$ (0800 to 0FFFFH) within 4 KB. $\overline{ce0}$ and $\overline{ce1}$ allow decoding of addresses in the ranges (0000 to 07FFFH) and (0800 to 0FFFFH) respectively within a 4-KB memory space.

(Example)

(1) Single-Scan

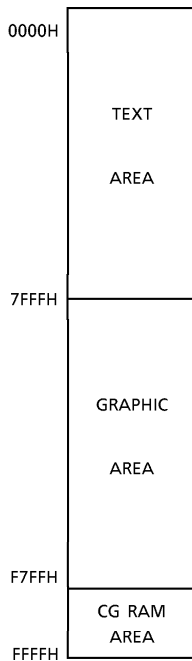

(2) Dual-Scan

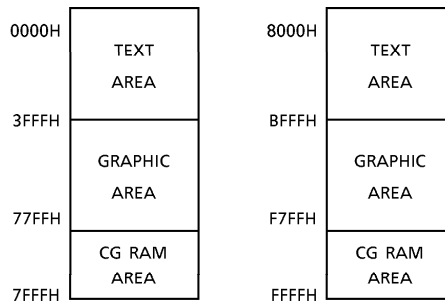

CG : Character Generator

- Flowchart of communications with MPU

(1) Status Read

A status check must be performed before data is read or written.

Status check

The Status of T6963C can be read from the data lines.

\overline{RD}	L
\overline{WR}	H
\overline{CE}	L
C/D	H
D0 to D7	Status word

The T6963C status word format is as follows:

MSB						LSB	
STA7	STA6	STA5	STA4	STA3	STA2	STA1	STA0
D7	D6	D5	D4	D3	D2	D1	D0
STA0	Check command execution capability					0 : Disable 1 : Enable	
STA1	Check data read / write capability					0 : Disable 1 : Enable	
STA2	Check Auto mode data read capability					0 : Disable 1 : Enable	
STA3	Check Auto mode data write capability					0 : Disable 1 : Enable	
STA4	Not used						
STA5	Check controller operation capability					0 : Disable 1 : Enable	
STA6	Error flag. Used for Screen Peek and Screen copy commands.					0 : No error 1 : Error	
STA7	Check the blink condition					0 : Display off 1 : Normal display	

- (Note 1) It is necessary to check STA0 and STA1 at the same time. There is a possibility of erroneous operation due to a hardware interrupt.
- (Note 2) For most modes STA0/STA1 are used as a status check.
- (Note 3) STA2 and STA3 are valid in Auto mode; STA0 and STA1 are invalid.

Status checking flow

a)

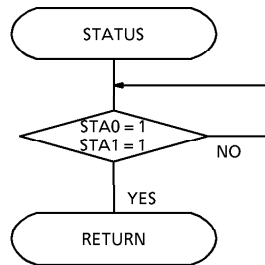

b)

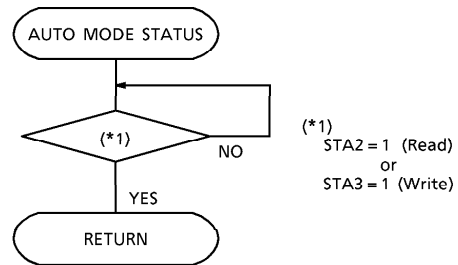

(Note 4) When using the MSB = 0 command, a Status Read must be performed. If a status check is not carried out, the T6963C cannot operate normally, even after a delay time. The hardware interrupt occurs during the address calculation period (at the end of each line). If a MSB = 0 command is sent to the T6963C during this period, the T6963C enters Wait status. If a status check is not carried out in this state before the next command is sent, there is the possibility that the command or data will not be received.

(2) Setting data

When using the T6963C, first set the data, then set the command.

Procedure for sending a command

a) The case of 1 data

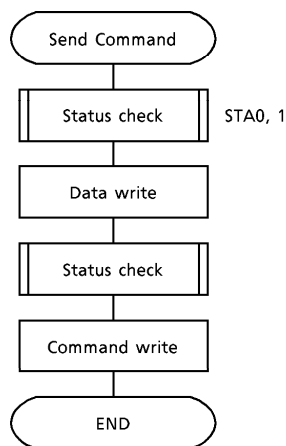

b) The case of 2 data

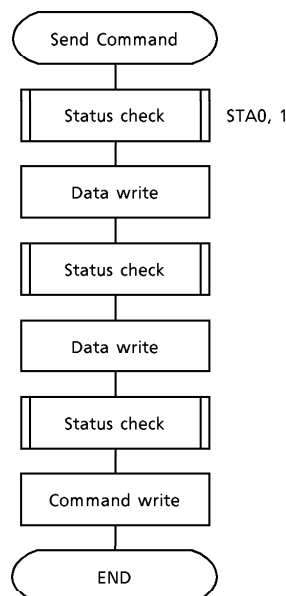

(Note) When sending more than two data, the last datum (or last two data) is valid.

COMMAND DEFINITIONS

COMMAND	CODE	D1	D2	FUNCTION
REGISTERS SETTING	00100001	X address	Y address	Set Cursor Pointer
	00100010	Data	00H	Set Offset Register
	00100100	Low address	High address	Set Address Pointer
SET CONTROL WORD	01000000	Low address	High address	Set Text Home Address
	01000001	Columns	00H	Set Text Area
	01000010	Low address	High address	Set Graphic Home Address
	01000011	Columns	00H	Set Graphic Area
MODE SET	1000X000	—	—	OR mode
	1000X001	—	—	EXOR mode
	1000X011	—	—	AND mode
	1000X100	—	—	Text Attribute mode
	10000XXX	—	—	Internal CG ROM mode
	10001XXX	—	—	External CG RAM mode
DISPLAY MODE	10010000	—	—	Display off
	1001XX10	—	—	Cursor on, blink off
	1001XX11	—	—	Cursor on, blink on
	100101XX	—	—	Text on, graphic off
	100110XX	—	—	Text off, graphic on
	100111XX	—	—	Text on, graphic on
CURSOR PATTERN SELECT	10100000	—	—	1-line cursor
	10100001	—	—	2-line cursor
	10100010	—	—	3-line cursor
	10100011	—	—	4-line cursor
	10100100	—	—	5-line cursor
	10100101	—	—	6-line cursor
	10100110	—	—	7-line cursor
	10100111	—	—	8-line cursor
DATA AUTO READ/ WRITE	10110000	—	—	Set Data Auto Write
	10110001	—	—	Set Data Auto Read
	10110010	—	—	Auto Reset
DATA READ/WRITE	11000000	Data	—	Data Write and Increment ADP
	11000001	—	—	Data Read and Increment ADP
	11000010	Data	—	Data Write and Decrement ADP
	11000011	—	—	Data Read and Decrement ADP
	11000100	Data	—	Data Write and Nonvariable ADP
	11000101	—	—	Data Read and Nonvariable ADP
SCREEN PEEK	11100000	—	—	Screen Peek
SCREEN COPY	11101000			Screen Copy

X : invalid

COMMAND	CODE	D1	D2	FUNCTION
BIT SET / RESET	11110XXX	—	—	Bit Reset
	11111XXX	—	—	Bit Set
	1111X000	—	—	Bit 0 (LSB)
	1111X001	—	—	Bit 1
	1111X010	—	—	Bit 2
	1111X011	—	—	Bit 3
	1111X100	—	—	Bit 4
	1111X101	—	—	Bit 5
	1111X110	—	—	Bit 6
	1111X111	—	—	Bit 7 (MSB)

X : invalid

● Setting registers

CODE	HEX.	FUNCTION	D1	D2
00100001	21H	SET CURSOR POINTER	X ADRS	Y ADRS
00100010	22H	SET OFFSET REGISTER	DATA	00H
00100100	24H	SET ADDRESS POINTER	LOW ADRS	HIGH ADRS

(1) Set Cursor Pointer

The position of the cursor is specified by X ADRS and Y ADRS. The cursor position can only be moved by this command. Data read/write from the MPU never changes the cursor pointer. X ADRS and Y ADRS are specified as follows.

- X ADRS 00H to 4FH (lower 7 bits are valid)
- Y ADRS 00H to 1FH (lower 5 bits are valid)

a) Single-Scan

X ADRS 00 to 4FH

Y ADRS 00H to 0FH

b) Dual-Scan

X ADRS 00H to 4FH

Y ADRS 00H to 0FH
Upper screen

Y ADRS 10H to 1FH
Lower screen

(2) Set Offset Register

The offset register is used to determine the external character generator RAM area. The T6963C has a 16-bit address bus as follows:

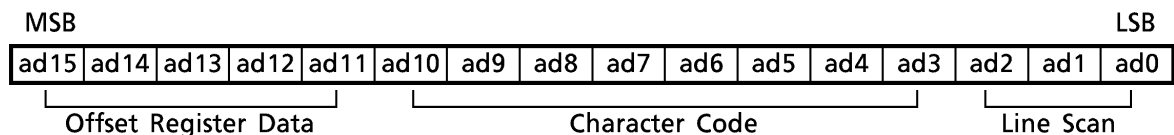

T6963C assign External character generator, when character code set 80H to FFH in using internal character generator. Character code 00H to 80H assign External character generator, when External generator mode.

The senior five bits define the start address in external memory of the CG RAM area. The next eight bits represent the character code of the character. In internal CG ROM mode, character codes 00H to 7FH represent the predefined "internal" CG ROM characters, and codes 80H to FFH represent the user's own "external" characters. In external CG RAM mode, all 256 codes from 00H to FFH can be used to represent the user's own characters. The three least significant bits indicate one of the eight rows of eight dots that define the character's shape.

The relationship between display RAM address and offset register

Offset register data	CG RAM hex. address (start to end)
00000	0000 to 07FFH
00001	0800 to 0FFFH
00010	1000 to 17FFH
11100	E000 to E7FFH
11101	E800 to EFFFH
11110	F000 to F7FFH
11111	F800 to FFFFH

(Example 1)

Offset register	02H				
Character code	80H				
Character generator RAM start address	0001	0100	0000	0000	
	1	4	0	0	H

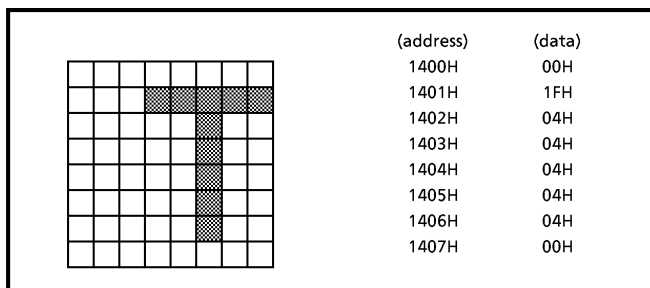

(Example 2) The relationship between display RAM data and display characters

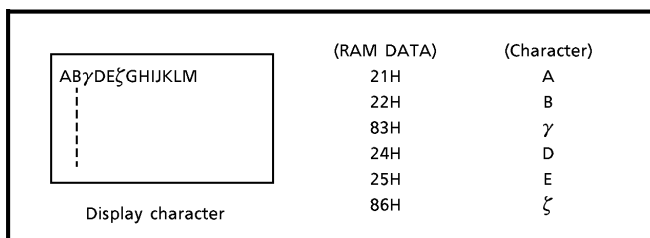

γ and ζ are displayed by character generator RAM.

(3) Set Address Pointer

The Set Address Pointer command is used to indicate the start address for writing to (or reading from) external RAM.

The Flowchart for Set Address Pointer command

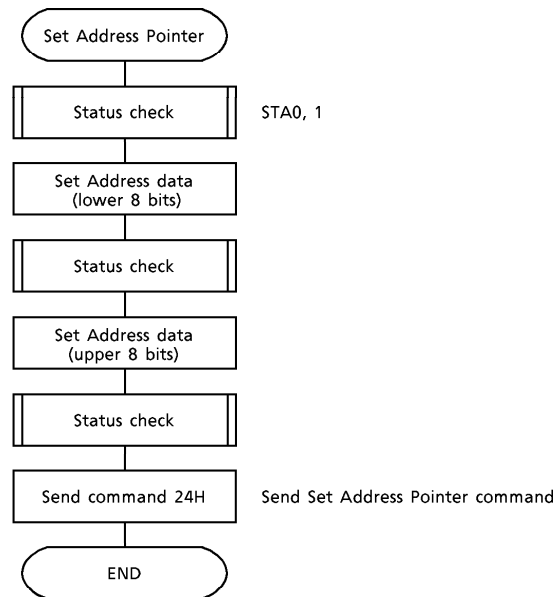

● Set Control Word

CODE	HEX.	FUNCTION	D1	D2
01000000	40H	Set Text Home Address	Low address	High address
01000001	41H	Set Text Area	Columns	00H
01000010	42H	Set Graphic Home Address	Low address	High address
01000011	43H	Set Graphic Area	Columns	00H

The home address and column size are defined by this command.

(1) Set Text Home Address

The starting address in the external display RAM for text display is defined by this command. The text home address indicates the leftmost and uppermost position.

The relationship between external display RAM address and display position

TH		TH + CL
TH + TA		TH + TA + CL
(TH + TA) + TA		TH + 2TA + CL
(TH + 2TA) + TA		TH + 3TA + CL
TH + (n-1) TA		TH + (n-1) TA + CL

TH : Text home address
 TA : Text area number (columns)
 CL : Columns are fixed by hardware (pin-programmable).

(Example)

Text home address : 0000H
 Text area : 0020H
 MD2 = H, MD3 = H : 32 columns
 $\overline{\text{DUAL}}$ = H, MDS = L, MD0 = L, MD1 = H : 4 lines

0000H	0001H		001EH	001FH
0020H	0021H		003EH	002FH
0040H	0041H		005EH	005FH
0060H	0061H		007EH	007FH

(2) Set Graphic Home Address

The starting address of the external display RAM used for graphic display is defined by this command. The graphic home address indicates the leftmost and uppermost position.

The relationship between external display RAM address and display position

GH		GH + CL
GH + GA		GH + GA + CL
(GH + GA) + GA		GH + 2GA + CL
(GH + 2GA) + GA		GH + 3GA + CL
GH + (n-1) GA		GH + (n-1) GA + CL

GH : Graphic home address
 GA : Graphic area number (columns)
 CL : Columns are fixed by hardware (pin-programmable).

(Example)

Graphic home address : 0000H
 Graphic area : 0020H
 MD2 = H, MD3 = H : 32 columns
 $\overline{\text{DUAL}}$ = H, MDS = L, MD0 = H, MD1 = H : 2 lines

0000H	0001H		001EH	001FH
0020H	0021H		003EH	003FH
0040H	0041H		005EH	005FH
0060H	0061H		007EH	007FH
0080H	0081H		009EH	009FH
00A0H	00A1H		00BEH	00BFH
00C0H	00C1H		00DEH	00DFH
00E0H	00E1H		00FEH	00FFH
0100H	0101H		011EH	011FH
0120H	0121H		013EH	013FH
0140H	0141H		015EH	015FH
0160H	0161H		017EH	017FH
0180H	0181H		019EH	019FH
01A0H	01A1H		01BEH	01BFH
01C0H	01C1H		01DEH	01DFH
01E0H	01E1H		01FEH	01FFH

(3) Set Text Area

The display columns are defined by the hardware setting. This command can be used to adjust the columns of the display.

(Example)

LCD size : 20 columns, 4 lines
 Text home address : 0000H
 Text area : 0014H
 MD2 = H, MD3 = H : 32 columns
 $\overline{\text{DUAL}}$ = H, MDS = L, MD0 = L, MD1 = H : 4 lines

0000	0001	0013	0014	001F
0014	0015	0027	0028	0033
0028	0029	003B	003C	0047
003C	003D	004F	0050	005B

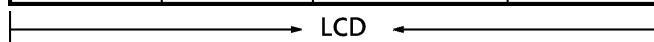

(4) Set Graphic Area

The display columns are defined by the hardware setting. This command can be used to adjust the columns of the graphic display.

(Example)

LCD size : 20 columns, 2 lines
 Graphic home address : 0000H
 Graphic area : 0014H
 MD2 = H, MD3 = H : 32 columns
 $\overline{\text{DUAL}}$ = H, MDS = L, MD0 = H, MD1 = H : 2 lines

0000	0001	0013	0014	001F
0014	0015	0027	0028	0033
0028	0029	003B	003C	0047
003C	003D	004F	0050	005B
0050	0051	0063	0064	006F
0064	0065	0077	0078	0083
0078	0079	008B	008C	0097
008C	008D	009F	00A0	00AB
00A0	00A1	00B3	00B4	00BF
00B4	00B5	00C7	00C8	00D3
00C8	00C9	00DB	00DC	00E7
00DC	00DD	00EF	00F0	00FD
00F0	00F1	0103	0104	011F
0104	0105	0127	0128	0123
0128	0129	013B	013C	0147
013C	013D	014F	0150	015B

If the graphic area setting is set to match the desired number of columns on the LCD, the addressing scheme will be automatically modified so that the start address of each line equals the end address of the previous line + 1.

- Mode set

CODE	FUNCTION	OPERAND
1000X000	OR Mode	—
1000X001	EXOR Mode	—
1000X011	AND Mode	—
1000X100	TEXT ATTRIBUTE Mode	—
10000XXX	Internal Character Generator Mode	—
10001XXX	External Character Generator Mode	—

X : invalid

The display mode is defined by this command. The display mode does not change until the next command is sent. The logical OR, EXOR, AND of text or graphic display can be displayed. In Internal Character Generator mode, character codes 00H to 7FH are assigned to the built-in character generator ROM. The character codes 80H to FFH are automatically assigned to the external character generator RAM.

(Example)

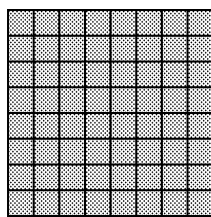

GRAPHIC

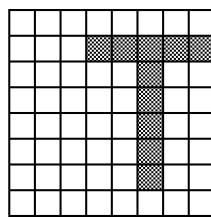

TEXT

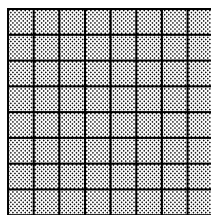

"OR"

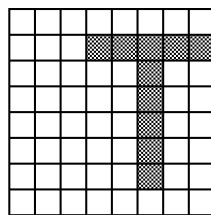

"AND"

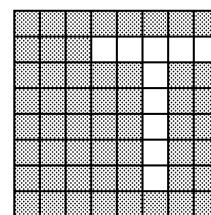

"EXOR"

(Note) Attribute functions can only be applied to text display, since the attribute data is placed in the graphic RAM area.

Attribute function

The attribute operations are Reverse display, Character blink and Inhibit. The attribute data is written into the graphic area which was defined by the Set Control Word command. Only text display is possible in Attribute Function mode; graphic display is automatically disabled. However, the Display Mode command must be used to turn both Text and Graphic on in order for the Attribute function to be available.

The attribute data for each character in the text area is written to the same address in the graphic area. The Attribute function is defined as follows.

Attribute RAM 1byte

X	X	X	X	d3	d2	d1	d0
---	---	---	---	----	----	----	----

d3	d2	d1	d0	FUNCTION
0	0	0	0	Normal display
0	1	0	1	Reverse display
0	0	1	1	Inhibit display
1	0	0	0	Blink of normal display
1	1	0	1	Blink of reverse display
1	0	1	1	Blink of inhibit display

X : invalid

● Display mode

CODE	FUNCTION	OPERAND
10010000	Display off	—
1001XX10	Cursor on, blink off	—
1001XX11	Cursor on, blink on	—
100101XX	Text on, graphic off	—
100110XX	Text off, graphic on	—
100111XX	Text on, graphic on	—

X : invalid

1	0	0	1	D3	D2	D1	D0
---	---	---	---	----	----	----	----

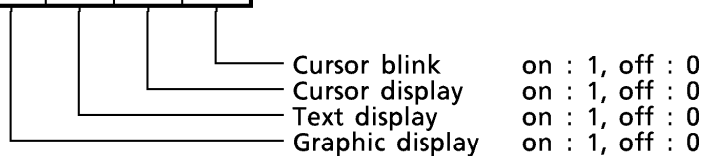

(Note) It is necessary to turn on "Text display" and "Graphic display" in the following cases.

- a) Combination of text / graphic display
- b) Attribute function

- Cursor pattern select

CODE	FUNCTION	OPERAND
10100000	1-line cursor	—
10100001	2-line cursor	—
10100010	3-line cursor	—
10100011	4-line cursor	—
10100100	5-line cursor	—
10100101	6-line cursor	—
10100110	7-line cursor	—
10100111	8-line cursor	—

When cursor display is ON, this command selects the cursor pattern in the range 1 line to 8 lines. The cursor address is defined by the Cursor Pointer Set command.

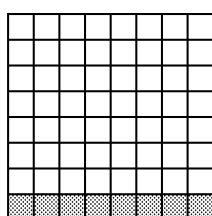

1-line cursor

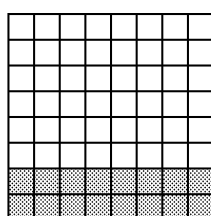

2-line cursor

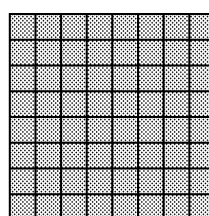

8-line cursor

- Data Auto Read /Write

CODE	HEX.	FUNCTION	OPERAND
10110000	B0H	Set Data Auto Write	—
10110001	B1H	Set Data Auto Read	—
10110010	B2H	Auto Reset	—

This command is convenient for sending a full screen of data from the external display RAM. After setting Auto mode, a Data Write (or Read) command is need not be sent between each datum. A Data Auto Write (or Read) command must be sent after a Set Address Pointer command. After this command, the address pointer is automatically incremented by 1 after each datum. In Auto mode, the T6963C cannot accept any other commands.

The Auto Reset command must be sent to the T6963C after all data has been sent, to clear Auto mode.

(Note) A Status check for Auto mode
 (STA2, STA3 should be checked between sending of each datum. Auto Reset should be performed after checking STA3 = 1 (STA2 = 1). Refer to the following flowchart.

a) Auto Read mode

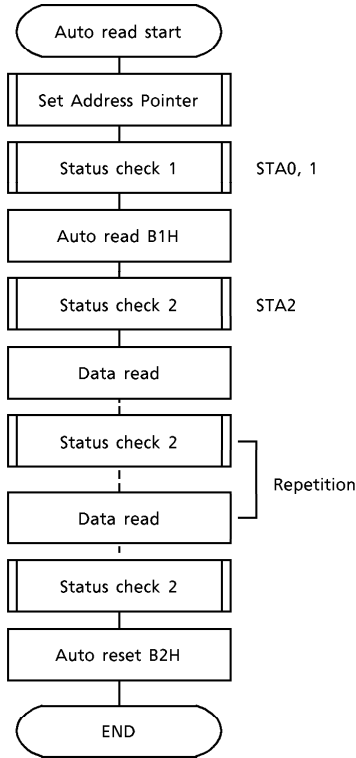

b) Auto Write mode

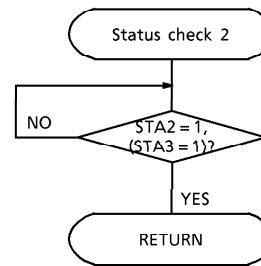
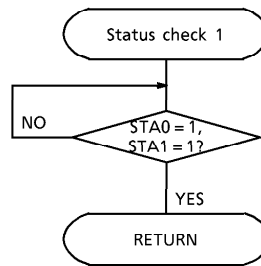
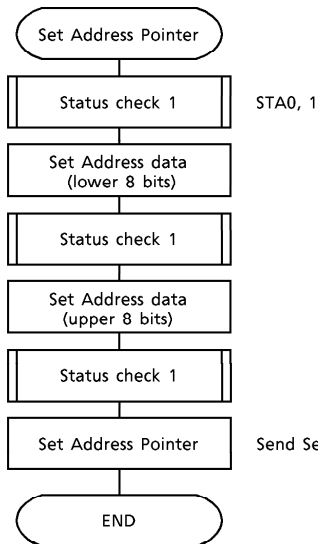
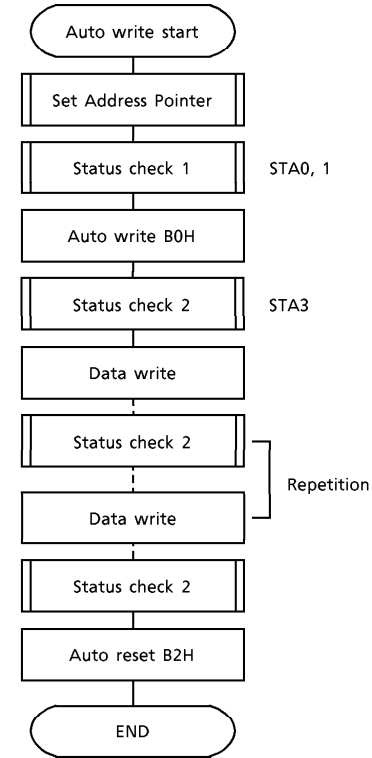

● Data Read / Write

CODE	HEX.	FUNCTION	OPERAND
11000000	C0H	Data Write and Increment ADP	Data
11000001	C1H	Data Read and Increment ADP	—
11000010	C2H	Data Write and Decrement ADP	Data
11000011	C3H	Data Read and Decrement ADP	—
11000100	C4H	Data Write and Nonvariable ADP	Data
11000101	C5H	Data Read and Nonvariable ADP	—

This command is used for writing data from the MPU to external display RAM, and reading data from external display RAM to the MPU. Data Write/Data Read should be executed after setting address using Set Address Pointer command. The address pointer can be automatically incremented or decremented using this command.

(Note) This command is necessary for each 1-byte datum.
Refer to the following flowchart.

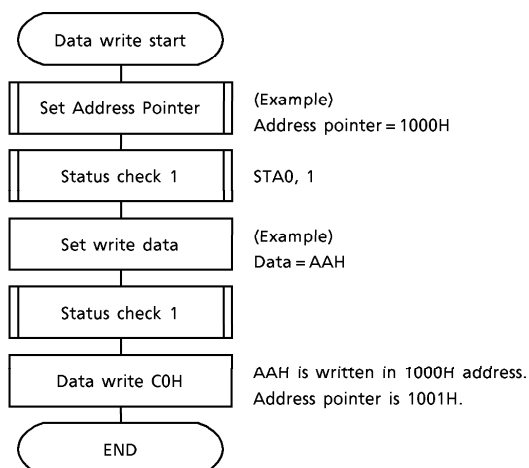

- Screen Peek

CODE	HEX.	FUNCTION	OPERAND
11100000	E0H	Screen Peek	—

This command is used to transfer 1 byte of displayed data to the data stack; this byte can then be read from the MPU by data access. The logical combination of text and graphic display data on the LCD screen can be read by this command.

The status (STA6) should be checked just after the Screen Peek command. If the address determined by the Set Address Pointer command is not in the graphic area, this command is ignored and a status flag (STA6) is set.

Refer to the following flowchart.

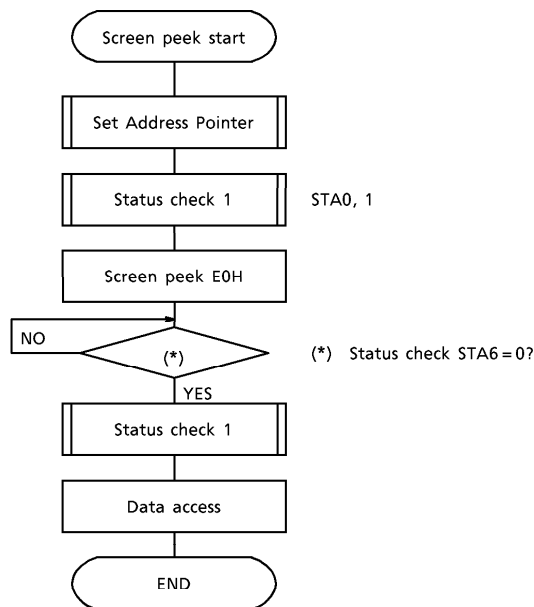

(Note) This command is available when hardware column number and software column number are the same. Hardware column number is related to MD2 and MD3 setting. Software column number is related to Set Text Area and Set Graphic Area command.

● Screen Copy

CODE	HEX.	FUNCTION	OPERAND
11101000	E8H	Screen Copy	—

This command copies a single raster line of data to the graphic area.
 The start point must be set using the Set Address Pointer command.

(Note 1) If the attribute function is being used, this command is not available.
 (With Attribute data is graphic area data.)

(Note 2) With Dual-Scan, this command cannot be used (because the T6963C cannot separate the upper screen data and lower screen data).

Refer to the following flowchart.

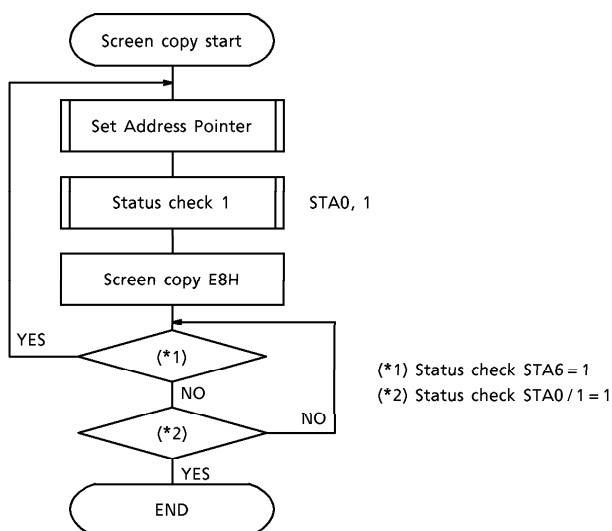

(Note) This command is available when hardware column number and software column number are the same. Hardware column number is related to MD2 and MD3 setting. Software column number is related to Set Text Area and Set Graphic Area command.

● Bit Set / Reset

CODE	FUNCTION	OPERAND
11110XXX	Bit Reset	—
11111XXX	Bit Set	—
1111X000	Bit 0 (LSB)	—
1111X001	Bit 1	—
1111X010	Bit 2	—
1111X011	Bit 3	—
1111X100	Bit 4	—
1111X101	Bit 5	—
1111X110	Bit 6	—
1111X111	Bit 7 (MSB)	—

X : invalid

This command use to set or reset a bit of the byte specified by the address pointer.
 Only one bit can be set/reset at a time.
 Refer to the following flowchart.

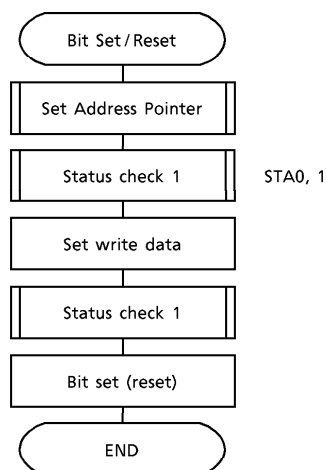

CHARACTER CODE MAP

The relation between character codes and character pattern (CG ROM TYPE 0101)

MSB LSB	0	1	2	3	4	5	6	7	8	9	A	B	C	D	E	F
0																
1																
2																
3																
4																
5																
6																
7																

The relation between character codes and character pattern (CG ROM TYPE 0201)

MSB \ LSB	0	1	2	3	4	5	6	7	8	9	A	B	C	D	E	F
0																
1																
2																
3																
4																
5																
6																
7																

ABSOLUTE MAXIMUM RATINGS (Ta = 25°C)

ITEM	SYMBOL	RATING	UNIT
Supply Voltage	V _{DD} (Note)	-0.3 to 7.0	V
Input Voltage	V _{IN} (Note)	-0.3 to V _{DD} +0.3	V
Operating Temperature	T _{opr}	-20 to 70	°C
Storage Temperature	T _{stg}	-55 to 125	°C

(Note) Referenced to V_{SS} = 0V.

ELECTRICAL CHARACTERISTICS

DC CHARACTERISTICS

TEST CONDITIONS (Unless otherwise noted, V_{SS} = 0V, V_{DD} = 5.0V ± 10%, Ta = -20 to 75°C)

ITEM	SYMBOL	TEST CIR-CUIT	TEST CONDITIONS	MIN	TYP.	MAX	UNIT	PIN NAME
Operating Voltage	V _{DD}	—	—	4.5	5.0	5.5	V	V _{DD}
Input	H Level	V _{IH}	—	V _{DD} - 2.2	—	V _{DD}	V	Input pins
	L Level	V _{IL}	—	0	—	0.8	V	Input pins
Output Voltage	H Level	V _{OH}	—	V _{DD} - 0.3	—	V _{DD}	V	Output pins
	L Level	V _{OL}	—	0	—	0.3	V	Output pins
Output Resistance	H Level	R _{OH}	V _{OUT} = V _{DD} - 0.5V	—	—	400	Ω	Output pins
	L Level	R _{OL}	V _{OUT} = 0.5V	—	—	400	Ω	Output pins
Input Pull-up Resistance	R _{PU}	—	—	50	100	200	kΩ	(Note 1)
Operating Frequency	f _{OSC}	—	—	0.4	—	5.5	MHz	
Current Consumption (Operating)	I _{DD} (1)	—	V _{DD} = 5.0V (Note 2) f _{OSC} = 3.0MHz	—	3.3	6	mA	V _{DD}
Current Consumption (Halt)	I _{DD} (2)	—	V _{DD} = 5.0V	—	—	3	μA	V _{DD}

(Note 1) Applied $\overline{T1}$, $\overline{T2}$, \overline{RESET}

(Note 2) MDS = L, MD0 = L, MD1 = L, MD2 = H, MD3 = H, FS0 = L, FS1 = L, \overline{SDSEL} = L, \overline{DUAL} = H, D7 to D0 = LHLHLHLH

AC CHARACTERISTICS

● Switching Characteristics (1)

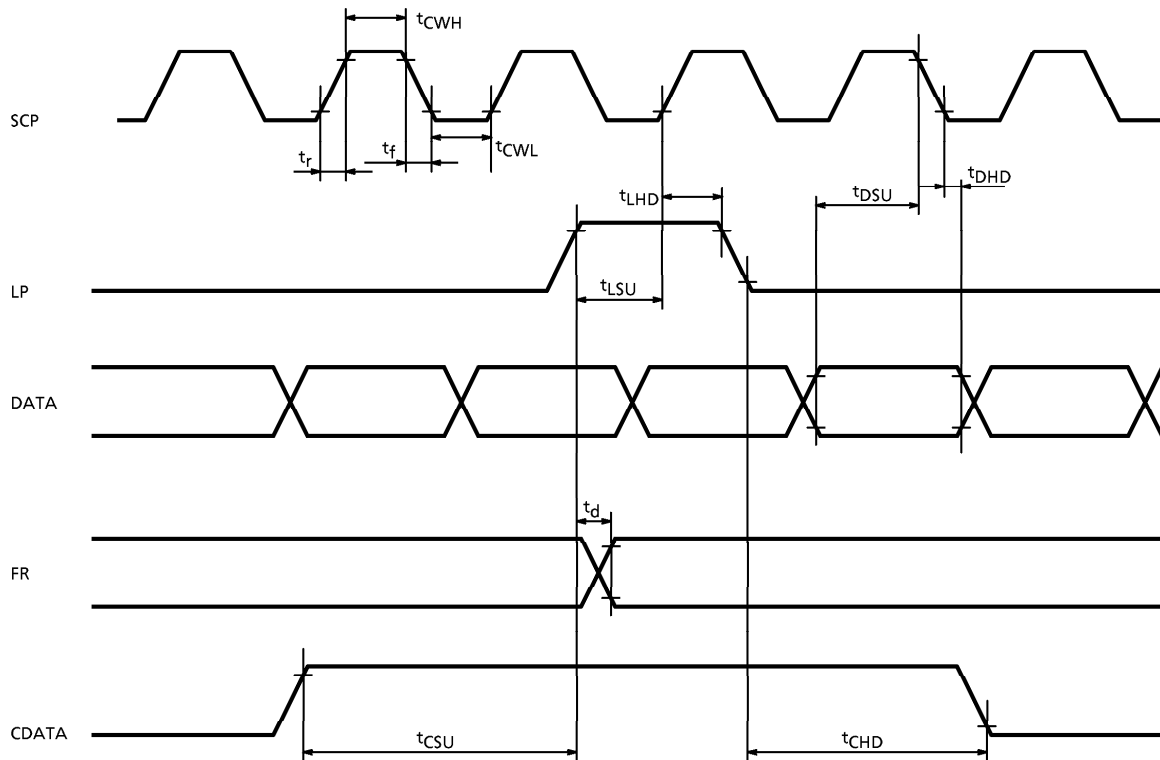

TEST CONDITIONS (Unless otherwise noted, $V_{DD} = 5.0V \pm 10\%$, $V_{SS} = 0V$, $T_a = -20$ to $70^{\circ}C$)

ITEM	SYMBOL	TEST CONDITIONS	MIN	MAX	UNIT
Operating Frequency	f_{scp}	$T_a = -10 \sim 70^{\circ}C$	—	2.75	MHz
SCP Pulse Width	t_{CWH}, t_{CWL}	—	150	—	ns
SCP Rise/Fall Time	t_r, t_f	—	—	30	ns
LP Set-up Time	t_{LSU}	—	150	290	ns
LP Hold Time	t_{LHD}	—	5	40	ns
Data Set-up Time	t_{DSU}	—	170	—	ns
Data Hold Time	t_{DHD}	—	80	—	ns
FR Delay Time	t_d	—	0	90	ns
CDATA Set-up Time	t_{CSU}	—	450	850	ns
CDATA Hold Time	t_{CHD}	—	450	950	ns

• Switching Characteristics (2)

Bus Timing

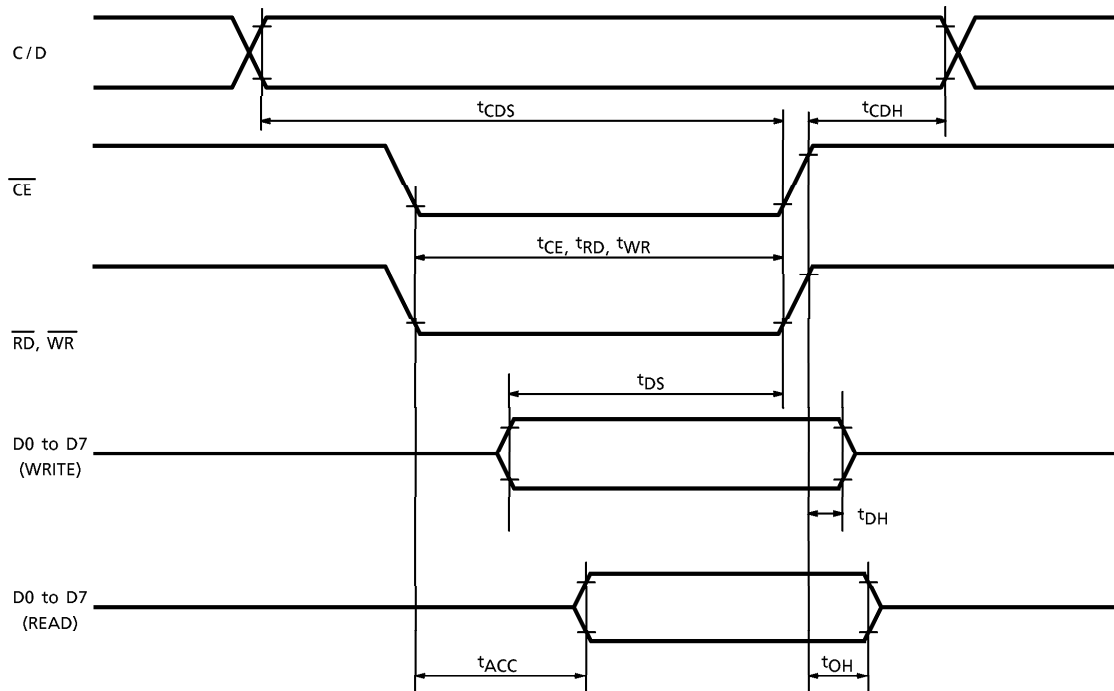

TEST CONDITIONS (Unless otherwise noted, $V_{DD} = 5.0V \pm 10\%$, $V_{SS} = 0V$, $T_a = -20$ to $75^\circ C$)

ITEM	SYMBOL	TEST CONDITIONS	MIN	MAX	UNIT
C/D Set-up Time	t_{CDS}	—	100	—	ns
C/D Hold Time	t_{CDH}	—	10	—	ns
\overline{CE} , \overline{RD} , \overline{WR} Pulse Width	t_{CE}, t_{RD}, t_{WR}	—	80	—	ns
Data Set-up Time	t_{DS}	—	80	—	ns
Data Hold Time	t_{DH}	—	40	—	ns
Access Time	t_{ACC}	—	—	150	ns
Output Hold Time	t_{OH}	—	10	50	ns

● Switching Characteristics (3)

(1) External RAM Read mode

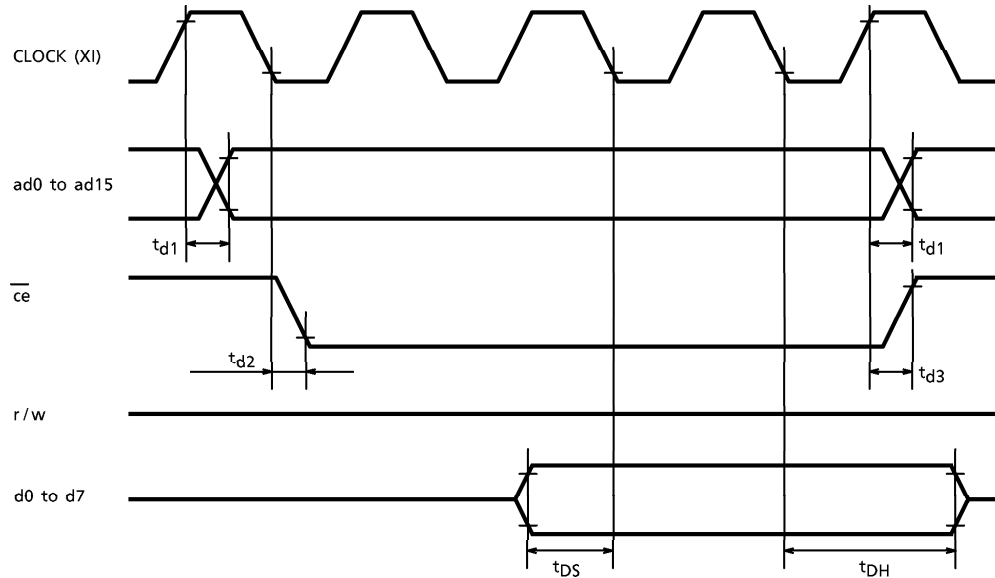

(2) External RAM Write mode

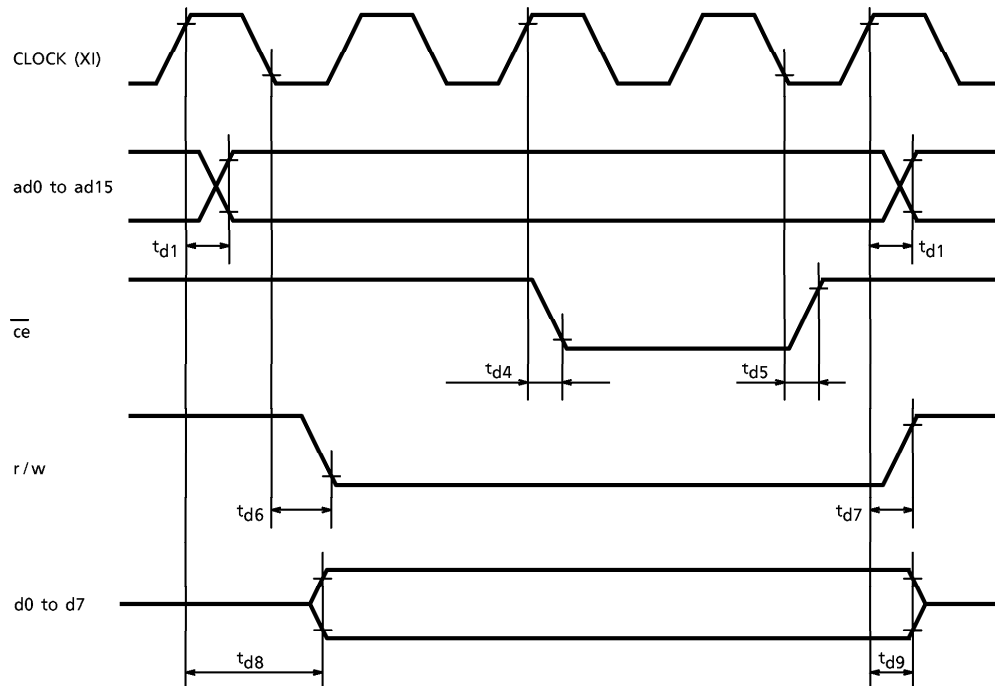

TEST CONDITIONS (Unless otherwise noted, $V_{DD} = 5.0V \pm 10\%$, $V_{SS} = 0V$, $T_a = -20$ to $70^\circ C$)

ITEM	SYMBOL	TEST CONDITIONS	MIN	MAX	UNIT
Address Delay Time	t_{d1}	—	—	250	ns
\overline{ce} Fall Delay Time (Read)	t_{d2}	—	—	180	ns
\overline{ce} Rise Delay Time (Read)	t_{d3}	—	—	180	ns
Data Set-up Time	t_{DS}	—	0	—	ns
Data Hold Time	t_{DH}	—	30	—	ns
\overline{ce} Fall Delay Time (Write)	t_{d4}	—	—	200	ns
\overline{ce} Rise Delay Time (Write)	t_{d5}	—	—	200	ns
r/w Fall Delay Time	t_{d6}	—	—	180	ns
r/w Rise Delay Time	t_{d7}	—	—	180	ns
Data Stable Time	t_{d8}	—	—	450	ns
Data Hold Time	t_{d9}	—	—	200	ns

T6963C EXAMPLE OF APPLICATION CIRCUIT

The T6963C can be directly connected to a TMPZ84C00A (Z80 (Note 1) CMOS). The T6963C can be used with a TMPZ84C00A as shown in the following application circuit.

- MPU memory address mapping

Data is transferred to the T6963C using a memory request signal.

	ADDRESS
DATA (I/O)	XXXXH
Command / Status	XXXX + 1H

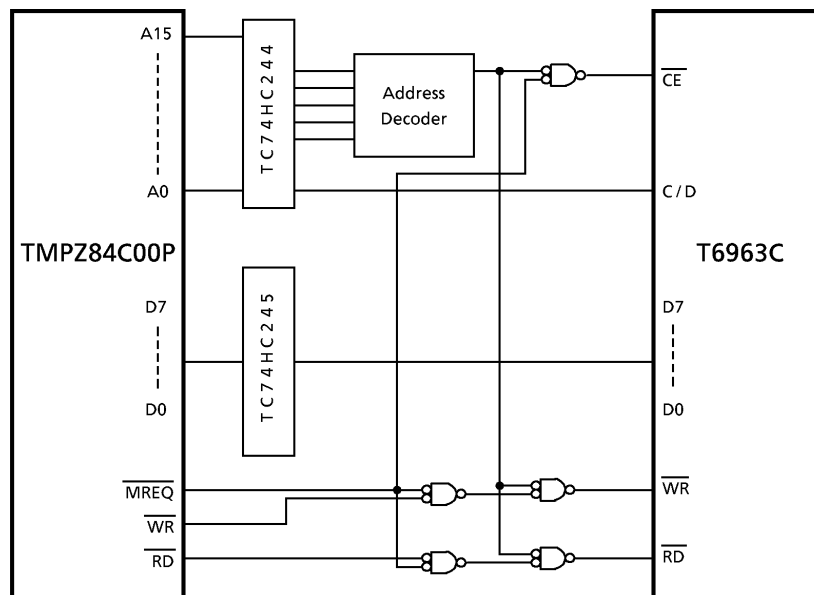

(Note 1) Z80 is a trademark of Zilog Inc.

- MPU I/O addressing

Data is transferred to the T6963C using an I/O request signal.

	I/O ADDRESS
DATA	XXH
Command / Status	XX + 1H

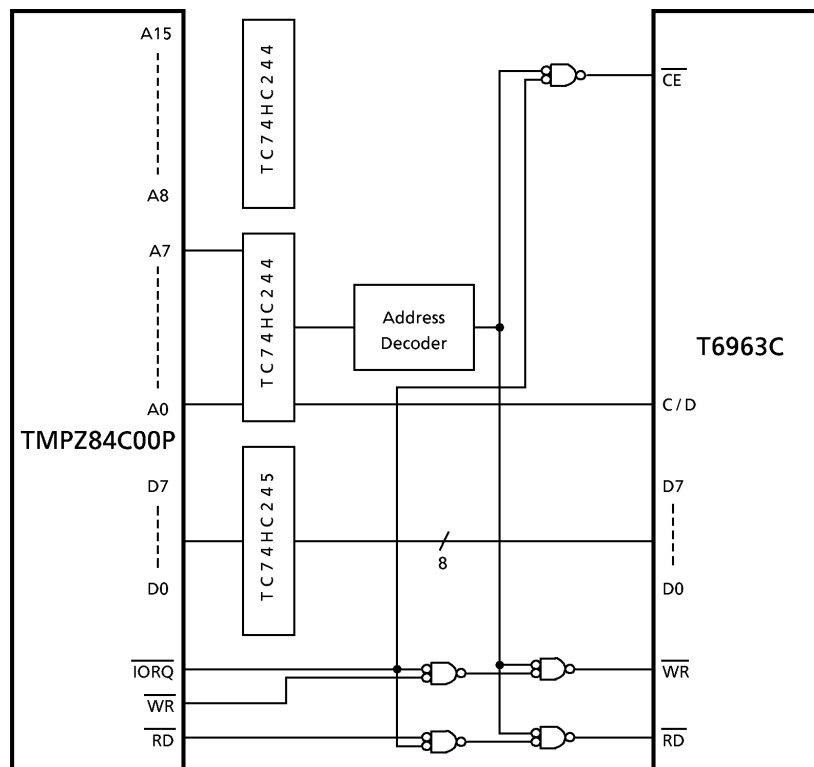

- When using PPI LSI (TMP82C55)

The T6963C can be connected to a PPI LSI.

The port A connects to the data bus.

The port C connects to the control bus. ($\overline{C/D}$, \overline{CE} , \overline{WR} , \overline{RD})

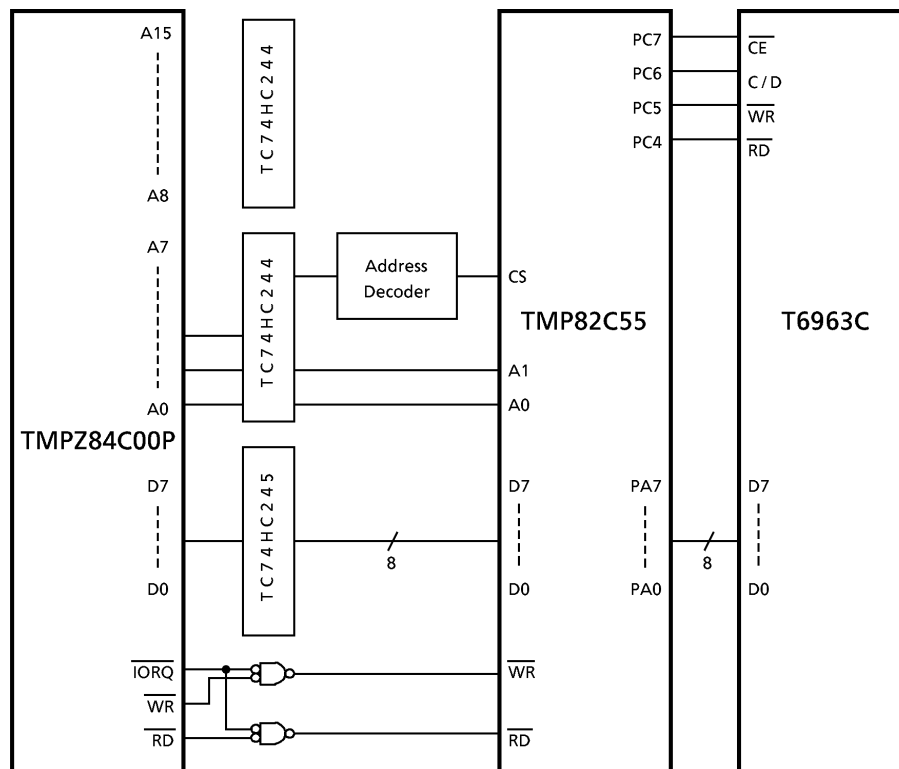

APPLICATION CIRCUIT (1)

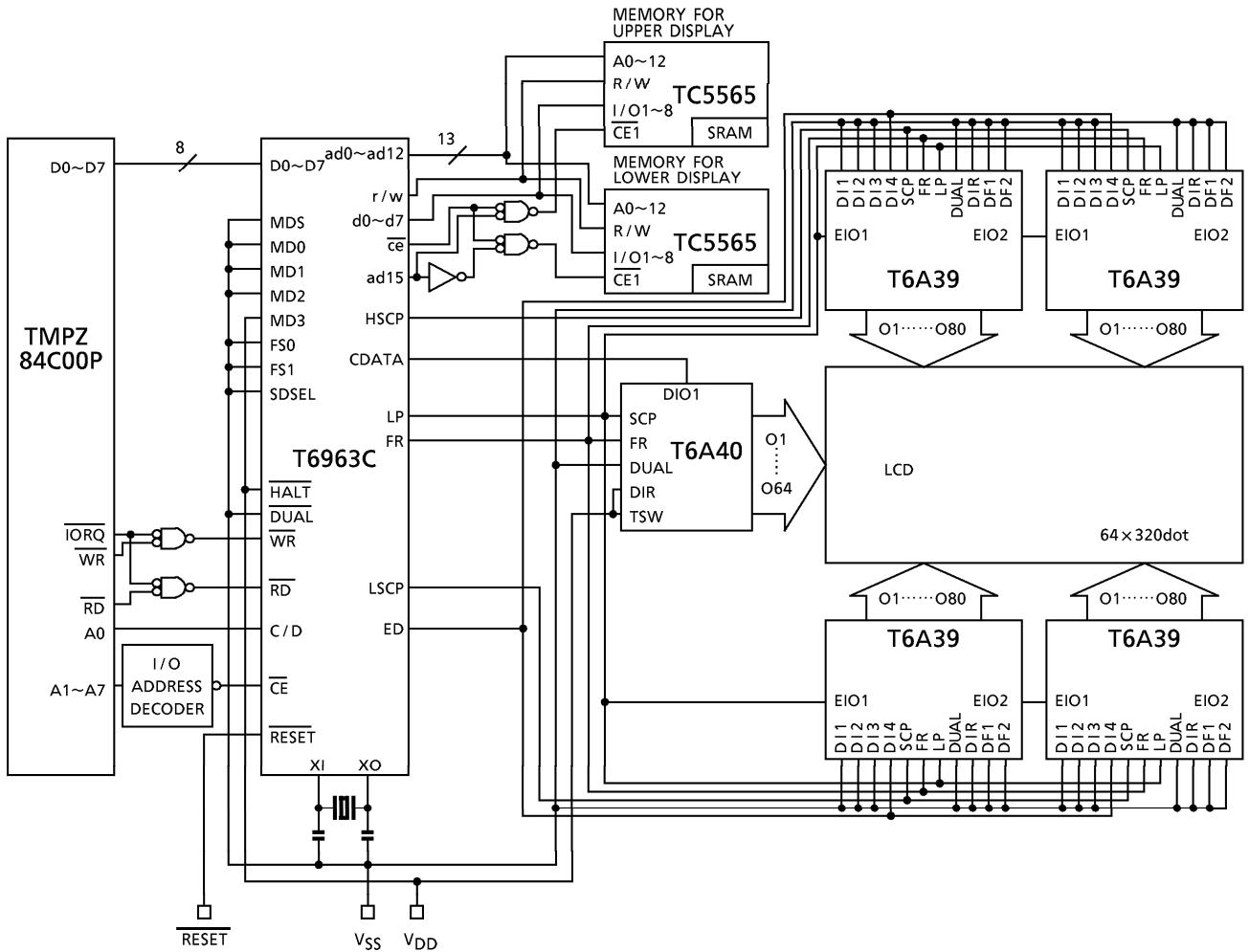

APPLICATION CIRCUIT (2)

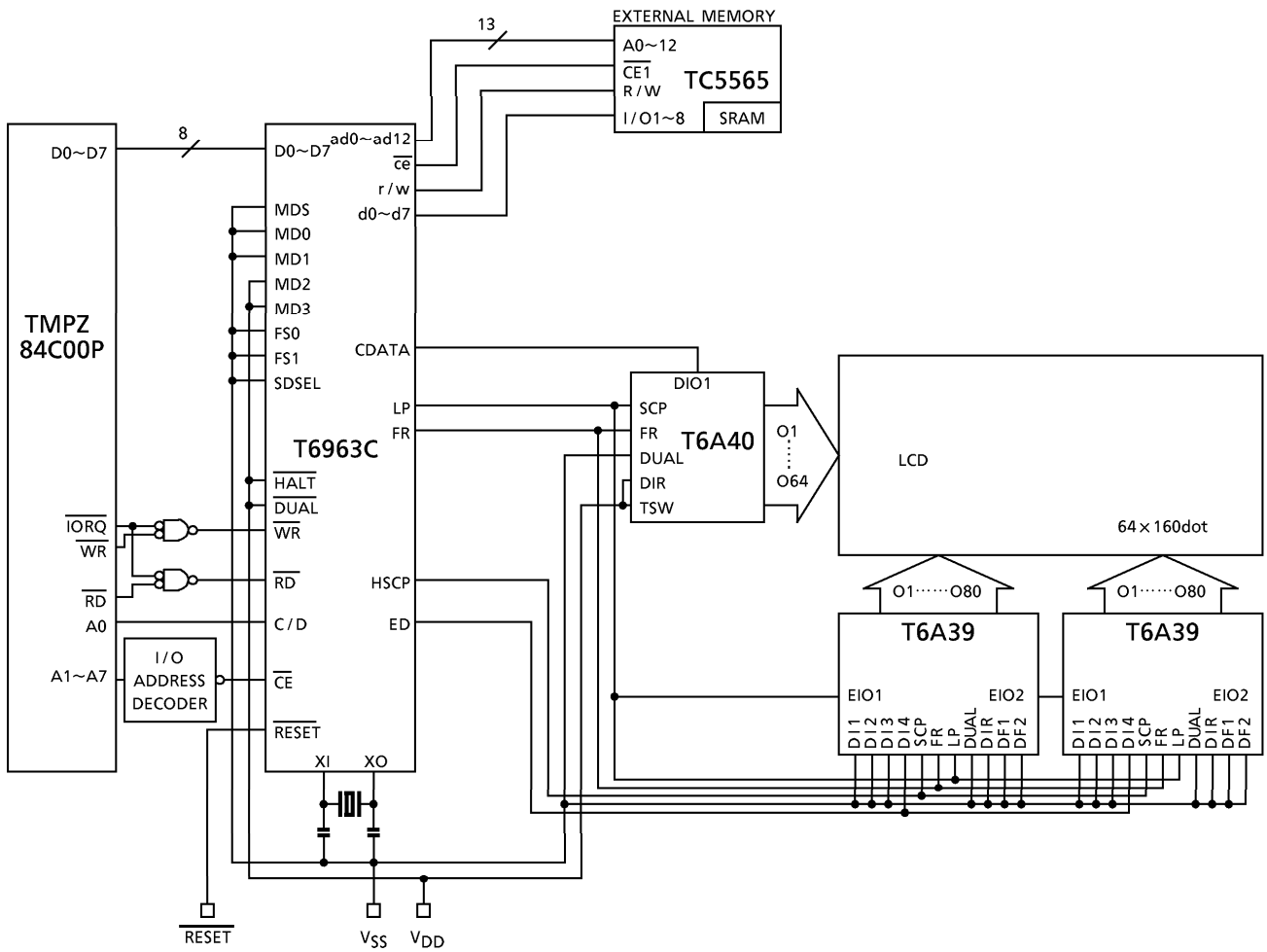

SAMPLE PROGRAM

```
1 : ; T6963C SAMPLE PROGRAM V0.01
2 : ;
3 : ; SOURCE PROGRAM for TMPZ84C00P
4 : ; 1991- 2-15
5 : ; Display Size : 20 Column x 8 Lines
6 : ;
7 : ; Character Font : 8 Dots Mode
8 : ;
9 : TXHOME EQU 40H ;SET TXT HM ADD
10 : TXAREA EQU 41H ;SET TXT AREA
11 : GRHOME EQU 42H ;SET GR HM ADD
12 : GRAREA EQU 43H ;SET GR AREA
13 : OFFSET EQU 22H ;SET OFFSET ADD
14 : ADPSET EQU 24H ;SET ADD PTR
15 : AWRON EQU 0B0H ;SET AUTO WRITE MODE
16 : AWROFF EQU 0B2H ;RESET AUTO WRITE MODE
17 : CMDP EQU 01H ;CMD PORT
18 : DP EQU 00H ;DATA PORT
19 : STACK EQU 9FFFH ;STACK POINTER BASE ADDRESS
20 : ;
21 : ORG 0000H
22 : START:
23 : LD SP,STACK
24 : ;
25 : ; SET TEXT HOME ADDRESS
26 : ;
27 : LD HL,0000H ; TEXT HOME ADDRESS 0000H
28 : CALL DT2
29 : LD A,TXHOME
30 : CALL CMD
31 : ;
32 : ; SET GRAPHIC HOME ADDRESS
33 : ;
34 : LD HL,0200H ; GRAPHIC HOME ADDRESS 0200H
35 : CALL DT2
36 : LD A,GRHOME
37 : CALL CMD
38 : ;
```

```
39 : ; SET TEXT AREA
40 : :
41 : LD HL,0014H ; TEXT AREA 20 Columns
42 : CALL DT2
43 : LD A,TXAREA
44 : CALL CMD
45 : :
46 : ; SET GRAPHIC AREA
47 : :
48 : LD HL,0014H ; GRAPHIC AREA 20 Columns
49 : CALL DT2
50 : LD A,GRAREA
51 : CALL CMD
52 : :
53 : ; MODE SET (OR MODE,Internal Character Generater MODE)
54 : :
55 : LD A,80H
56 : CALL CMD
57 : :
58 : ; SET OFFSET REGISTER (00010 10000000 000=1400H CG RAM START ADDRESS)
59 : ; CHARACTER CODE 80H
60 : LD HL,0002H
61 : CALL DT2
62 : LD A,OFFSET
63 : CALL CMD
64 : :
65 : ; DISPLAY MODE
66 : ; (TEXT ON,GRAPHICS OFF,CURSOR OFF)
67 : :
68 : LD A,94H
69 : CALL CMD
70 : :
71 : ; WRITE TEXT BLANK CODE
72 : :
73 : LD HL,0000H ; SET Address Pointer 0000H
74 : CALL DT2 ; (TEXT HOME ADDRESS)
75 : LD A,ADPSET
76 : CALL CMD
77 : :
78 : LD A,AWRON ; SET DATA AUTO WRITE
```

```

79 :          CALL    CMD          ;
80 :
81 :          LD      BC,00A0H      ; 20 Columns x 8Lines (160=A0H)
82 : TXCR:
83 :          LD      A,00H         ; WRITE DATA 00H
84 :          CALL    ADT           ; (WRITE BLANK CODE)
85 :
86 :          DEC     BC
87 :          LD      A,B
88 :          OR      C
89 :          JR      NZ,TXCR
90 :
91 :          LD      A,AWROFF       ; AUTO RESET
92 :          CALL    CMD
93 :
94 :          :
95 :          ; WRITE EXTERNAL CHARACTER GENERATOR DATA
96 :          :
97 :          LD      DE,EXTCG       ; CG data address in Program
98 :          LD      HL,1400H       ; CG RAM Start Address (1400H)
99 :          CALL    DT2
100 :         LD      A,ADPSET
101 :         CALL    CMD
102 :         :
103 :         LD      A,AWRON        ; SET DATA AUTO WRITE
104 :         CALL    CMD
105 :
106 :         LD      B,40H         ; 8 Character x 8 byte (64=40H)
107 : EXCG:
108 :         LD      A,(DE)        ; WRITE DATA TO EXTERNAL RAM
109 :         CALL    ADT           ;
110 :         INC     HL
111 :         INC     DE
112 :         DJNZ   EXCG
113 :
114 :         LD      A,AWROFF       ; AUTO RESET
115 :         CALL    CMD
116 :         :
117 :         ; WRITE TEXT DISPLAY DATA (INTERNAL CG)
118 :         :

```



```
119 :          LD      HL,0040H          ; Address Pointer 3Line,4Column
120 :          CALL   DT2
121 :          LD      A,ADPSET
122 :          CALL   CMD
123 :
124 :          LD      A,AWRON          ; SET DATA AUTO WRITE
125 :          CALL   CMD
126 :
127 :          LD      B,0DH          ; 13 Character
128 :          LD      DE, TXPRT
129 : TXLP1:
130 :          LD      A,(DE)          ; WRITE DATA
131 :          CALL   ADT
132 :          INC     DE
133 :          DJNZ   TXLP1
134 :
135 :          LD      A,AWROFF        ; AUTO RESET
136 :          CALL   CMD
137 :          :
138 :          ; WRITE TEXT DISPLAY DATA (EXTERNAL CG upper part)
139 :          :
140 :          LD      HL,006CH          ; Address Pointer 5Line,8Column
141 :          CALL   DT2
142 :          LD      A,ADPSET
143 :          CALL   CMD
144 :
145 :          LD      A,AWRON          ; SET DATA AUTO WRITE
146 :          CALL   CMD
147 :
148 :          LD      B,06H          ; 6 Character
149 :          LD      DE, EXPRT1
150 : TXLP2:
151 :          LD      A,(DE)          ; WRITE DATA
152 :          CALL   ADT
153 :          INC     DE
154 :          DJNZ   TXLP2
155 :
156 :          LD      A,AWROFF        ; AUTO RESET
157 :          CALL   CMD
158 :          :
```

```
159 : ; WRITE TEXT DISPLAY DATA (EXTERNAL CG lower part)
160 : :
161 : LD HL,0080H ; Address Pointer 6Line,8Column
162 : CALL DT2
163 : LD A,ADPSET
164 : CALL CMD
165 :
166 : LD A,AWRON ; SET DATA AUTO WRITE
167 : CALL CMD
168 :
169 : LD B,06H ; 6 Character
170 : LD DE,EXPRT2
171 : TXLP3:
172 : LD A,(DE) ; WRITE DATA
173 : CALL ADT
174 : INC DE
175 : DJNZ TXLP3
176 :
177 : LD A,AWROFF ; AUTO RESET
178 : CALL CMD
179 : PEND:
180 : JP PEND ; PROGRAM END
181 : :
182 : ;Subroutine start
183 : :
184 : ; COMMAND WRITE ROUTINE
185 : :
186 : CMD:
187 : PUSH AF
188 : CMD1: IN A,(CMDP)
189 : AND 03H
190 : CP 03H ; STATUS CHECK
191 : JR NZ,CMD1
192 : POP AF
193 : OUT (CMDP),A ; WRITE COMMAND
194 : RET
195 : :
196 : ; DATA WRITE (1 byte) ROUTINE
197 : :
198 : DT1:
```

```
199 :          PUSH    AF
200 :   DT11:    IN      A,(CMDP)
201 :          AND      03H
202 :          CP       03H          ; STATUS CHECK
203 :          JR       NZ,DT11
204 :          POP      AF
205 :          OUT      (DP),A        ; WRITE DATA
206 :          RET
207 :          :
208 :          ; DATA WRITE (2 byte) ROUTINE
209 :          :
210 :   DT2:
211 :          IN      A,(CMDP)
212 :          AND      03H
213 :          CP       03H          ; STATUS CHECK
214 :          JR       NZ,DT2
215 :          LD      A,L
216 :          OUT      (DP),A        ; WRITE DATA (D1)
217 :   DT21:
218 :          IN      A,(CMDP)
219 :          AND      03H
220 :          CP       03H          ; STATUS CHECK
221 :          JR       NZ,DT21
222 :
223 :          LD      A,H
224 :          OUT      (DP),A        ; WRITE DATA (D2)
225 :          RET
226 :          :
227 :          ; AUTO WRITE MODE ROUTINE
228 :          :
229 :   ADT:
230 :          PUSH    AF
231 :   ADT1:    IN      A,(CMDP)
232 :          AND      08H
233 :          CP       08H          ; STATUS CHECK
234 :          JR       NZ,ADT1
235 :          POP      AF
236 :          OUT      (DP),A        ; WRITE DATA
237 :          RET
238 :          :
```

```
239 : ;Subroutine end
240 :
241 : ; TEXT DISPLAY CHARACTER CODE
242 :
243 : TXPRT:
244 :     DEFB     34H, 00H, 2FH, 00H, 33H, 00H ; INTERNAL CG CODE
245 :     DEFB     28H, 00H, 29H, 00H, 22H, 00H, 21H
246 : EXPRT1:
247 :     DEFB     80H, 81H, 00H, 00H, 84H, 85H ; EXTERNAL CG CODE
248 : EXPRT2:
249 :     DEFB     82H, 83H, 00H, 00H, 86H, 87H
250 :
251 : ; EXTERNAL CG FONT DATA
252 :
253 : EXT CG:
254 :
255 : ; 「東」 upper/left CHARACTER CODE 80H
256 :     DEFB     01H, 01H,0FFH, 01H, 3FH, 21H, 3FH, 21H
257 :
258 : ; 「東」 upper/right CHARACTER CODE 81H
259 :     DEFB     00H, 00H,0FFH, 00H,0FCH, 04H,0FCH, 04H
260 :
261 : ; 「東」 lower/left CHARACTER CODE 82H
262 :     DEFB     21H, 3FH, 05H, 0DH, 19H, 31H,0E1H, 01H
263 :
264 : ; 「東」 lower/right CHARACTER CODE 83H
265 :     DEFB     04H,0FCH, 40H, 60H, 30H, 1CH, 07H, 00H
266 :
267 : ; 「芝」 upper/left CHARACTER CODE 84H
268 :     DEFB     08H, 08H,0FFH, 08H, 09H, 01H, 01H, 7FH
269 :
270 : ; 「芝」 upper/right CHARACTER CODE 85H
271 :     DEFB     10H, 10H,0FFH, 10H, 10H, 00H, 00H,0FCH
272 :
273 : ; 「芝」 lower/left CHARACTER CODE 86H
274 :     DEFB     00H, 00H, 00H, 01H, 07H, 3CH,0E7H, 00H
275 :
276 : ; 「芝」 lower/right CHARACTER CODE 87H
277 :     DEFB     18H, 30H, 60H,0C0H, 00H, 00H,0E0H, 3FH
278 :
279 :     END
```

DISPLAY SAMPLE

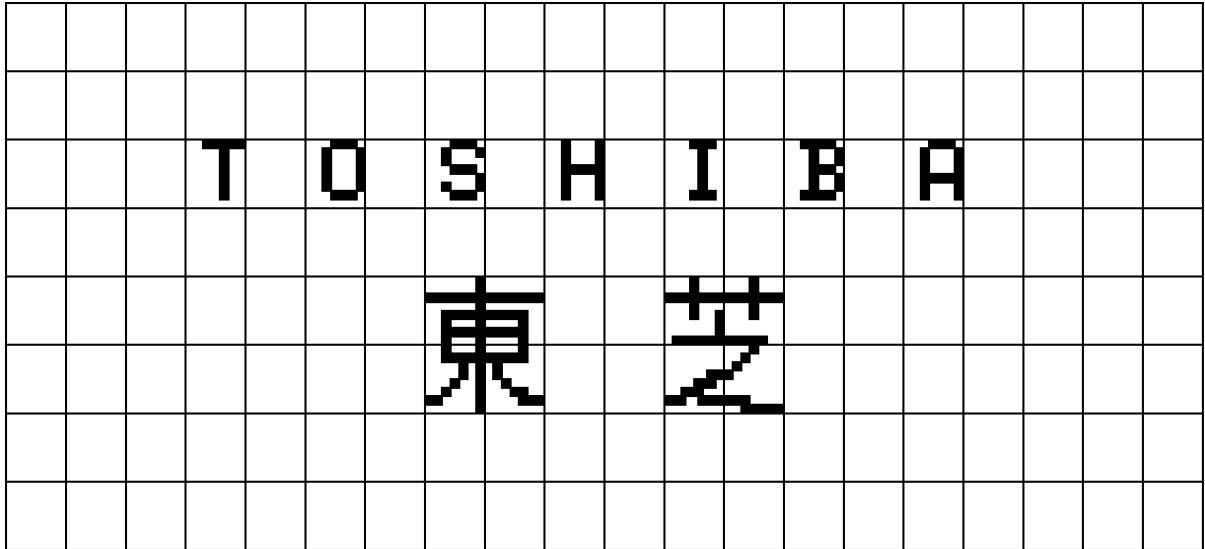

OUTLINE DRAWING
QFP67-P-1420-0.80

Unit : mm

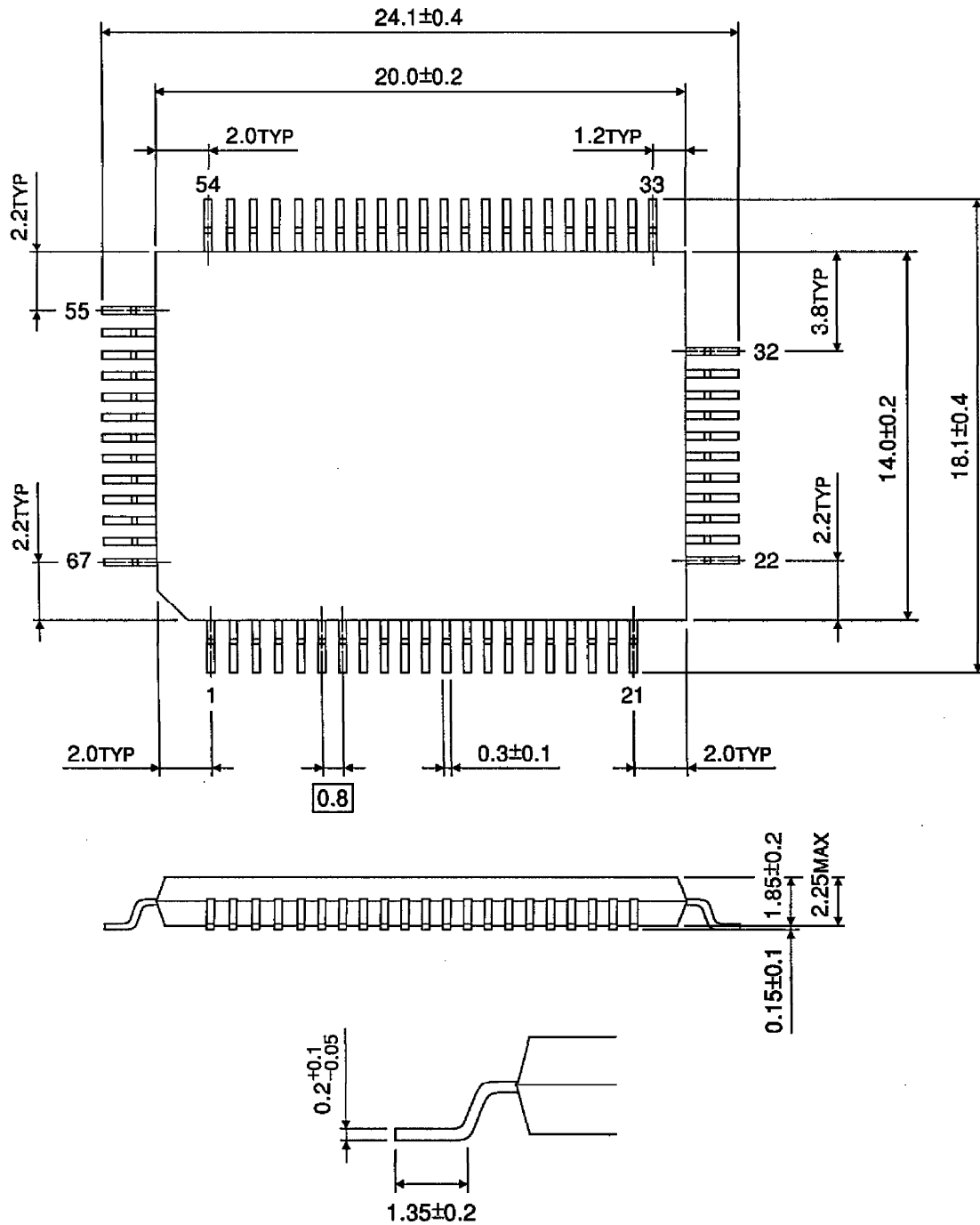

Weight : 1.2g (Typ.)