

74FR240

Octal Buffer/Line Driver with 3-STATE Outputs

General Description

The 74FR240 is an inverting octal buffer and line driver designed to be employed as memory and address driver, clock driver and bus oriented transmitter or receiver.

Features

- 3-STATE outputs drive bus lines or buffer memory address registers
- Outputs sink 64 mA and source 15 mA
- Guaranteed pin-to-pin skew

Ordering Code:

Order Number	Package Number	Package Description
74FR240SC	M20B	20-Lead Small Outline Integrated Circuit (SOIC), JEDEC MS-013, 0.300 Wide
74FR240SJ	M20D	20-Lead Small Outline Package (SOP), EIAJ TYPE II, 5.3mm Wide
74FR240PC	N20A	20-Lead Plastic Dual-In-Line Package (PDIP), JEDEC MS-001, 0.300 Wide

Devices also available in Tape and Reel. Specify by appending the suffix letter "X" to the ordering code.

Connection Diagram

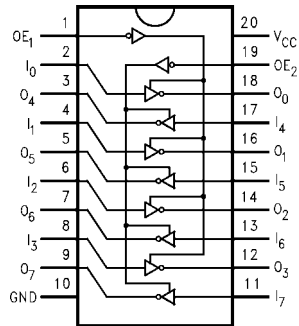

Pin Descriptions

Pin Names	Description
$\overline{OE}_1, \overline{OE}_2$	Output Enable Input (Active-LOW)
I_0-I_7	Inputs
$\overline{O}_0-\overline{O}_7$	Outputs

Truth Tables

Inputs		Outputs
\overline{OE}_1	I_n	(Pins 12, 14, 16, 18)
L	L	H
L	H	L
H	X	Z

Inputs		Outputs
\overline{OE}_2	I_n	(Pins 3, 5, 7, 9)
L	L	H
L	H	L
H	X	Z

H = HIGH Voltage Level
L = LOW Voltage Level
X = Immaterial
Z = High Impedance

Absolute Maximum Ratings (Note 1)

Storage Temperature	-65°C to +150°C
Ambient Temperature under Bias	-55°C to +125°C
Junction Temperature under Bias	-55°C to +150°C
V _{CC} Pin Potential to Ground Pin	-0.5V to +7.0V
Input Voltage (Note 2)	-0.5V to +7.0V
Input Current (Note 2)	-30 mA to +5.0 mA
Voltage Applied to Output in HIGH State (with V _{CC} = 0V)	
Standard Output	-0.5V to V _{CC}
3-STATE Output	-0.5V to +5.5V
Current Applied to Output in LOW State (Max)	Twice the Rated I _{OL} (mA)
ESD Last Passing Voltage (Min)	4000V

Recommended Operating Conditions

Free Air Ambient Temperature	0°C to +70°C
Supply Voltage	+4.5V to +5.5V

Note 1: Absolute maximum ratings are values beyond which the device may be damaged or have its useful life impaired. Functional operation under these conditions is not implied.

Note 2: Either voltage limit or current limit is sufficient to protect inputs.

DC Electrical Characteristics

Symbol	Parameter	Min	Typ	Max	Units	V _{CC}	Conditions
V _{IH}	Input HIGH Voltage	2.0			V		Recognized HIGH Signal
V _{IL}	Input LOW Voltage			0.8	V		Recognized LOW Signal
V _{CD}	Input Clamp Diode Voltage			-1.2	V	Min	I _{IN} = -18 mA
V _{OH}	Output HIGH Voltage	2.4			V	Min	I _{OH} = -3 mA
		2.0			V	Min	I _{OH} = -15 mA
V _{OL}	Output LOW Voltage			0.55	V	Min	I _{OL} = 64 mA
I _{IH}	Input HIGH Current			5	μA	Max	V _{IN} = 2.7V
I _{BVI}	Input HIGH Current Breakdown Test			7	μA	Max	V _{IN} = 7.0V
I _{IL}	Input Low Current			-150	μA	Max	V _{IN} = 0.5V
V _{ID}	Input Leakage Test	4.75			V	0.0	I _{ID} = 1.9 μA, All Other Pins Grounded
I _{OD}	Output Circuit Leakage Current			3.75	μA	0.0	V _{IOD} = 150 mV, All Other Pins Grounded
I _{OZH}	Output Leakage Current			20	μA	Max	V _{OUT} = 2.7V
I _{OZL}	Output Leakage Current			-20	μA	Max	V _{OUT} = 0.5V
I _{OS}	Output Short-Circuit Current	-100		-225	mA	Max	V _{OUT} = 0.0V
I _{CEX}	Output HIGH Leakage Current			50	μA	Max	V _{OUT} = V _{CC}
I _{ZZ}	Bus Drainage Test			100	μA	0.0	V _{OUT} = 5.25V
I _{CCH}	Power Supply Current		9	13	mA	Max	All Outputs HIGH
I _{CCL}	Power Supply Current		37	45	mA	Max	All Outputs LOW
I _{CCZ}	Power Supply Current		31	38	mA	Max	Outputs 3-STATE
C _{IN}	Input Capacitance		8.0		pF	5.0	

AC Electrical Characteristics							
Symbol	Parameter	T _A = +25°C V _{CC} = +5.0V C _L = 50 pF			T _A = 0°C to +70°C V _{CC} = +5.0V C _L = 50 pF		Units
		Min	Typ	Max	Min	Max	
t _{PLH}	Propagation Delay	1.0	3.3	4.7	1.0	4.7	ns
t _{PHL}	A _n to B _n or B _n to A _n	1.0	2.9	4.7	1.0	4.7	
t _{PZH}	Output Enable Time	2.6	4.0	7.0	2.6	7.0	ns
t _{PZL}		2.6	6.3	7.0	2.6	7.0	
t _{PHZ}	Output Disable Time	1.7	3.3	6.6	1.7	6.6	ns
t _{PLZ}		1.7	2.9	6.6	1.7	6.6	
Extended AC Electrical Characteristics							
Symbol	Parameter	T _A = 0°C to +70°C V _{CC} = +5.0V C _L = 50 pF Eight Outputs Switching (Note 3)		T _A = 0°C to +70°C V _{CC} = +5.0V C _L = 250 pF (Note 4)		Units	
		Min	Max	Min	Max		
t _{PLH}	Propagation Delay	1.0	6.4	2.3	8.3	ns	
t _{PHL}	A _n to B _n or B _n to A _n	1.0	6.4	2.3	8.3		
t _{PZH}	Output Enable Time	2.6	7.2			ns	
t _{PZL}		2.6	7.2				
t _{PHZ}	Output Disable Time	1.7	6.8			ns	
t _{PLZ}		1.7	6.8				
t _{OSHL} (Note 5)	Pin-to-Pin Skew for HL Transitions		2.0			ns	
t _{OSLH} (Note 5)	Pin-to-Pin Skew for LH Transitions		1.1				
t _{OST} (Note 5)	Pin-to-Pin Skew for HL/LH Transitions		3.1			ns	

Note 3: This specification is guaranteed but not tested. The limits apply to propagation delays for all paths described switching in phase, i.e., all LOW-to-HIGH, HIGH-to-LOW, 3-STATE-to-HIGH, etc.

Note 4: These specifications guaranteed but not tested. The limits represent propagation delays with 250 pF load capacitors in place of the 50 pF load capacitors in the standard AC load. This specification pertains to single output switching only.

Note 5: Skew is defined as the absolute value of the difference between the actual propagation delays for any two outputs of the same device. The specification applies to any outputs switching HIGH-to-LOW, (t_{OSHL}), LOW-to-HIGH, (t_{OSLH}), or HIGH-to-LOW and/or LOW-to-HIGH, (t_{OST}). Specifications guaranteed with all outputs switching in phase.

Physical Dimensions inches (millimeters) unless otherwise noted

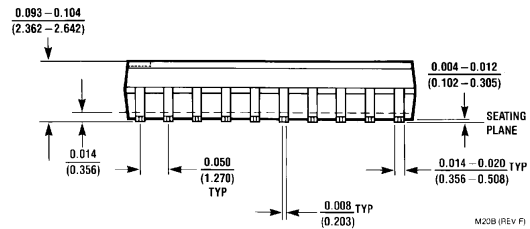
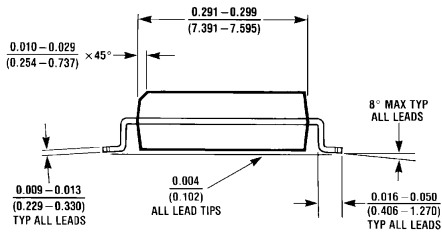
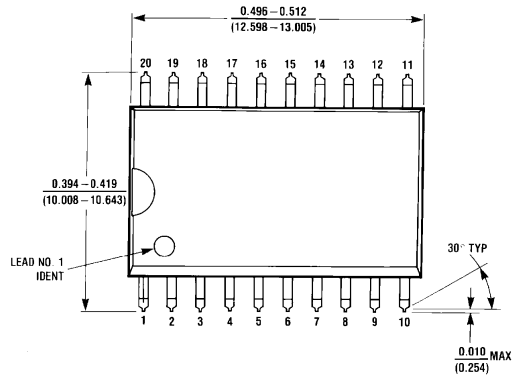

M20B (REV F)

**20-Lead Small Outline Integrated Circuit (SOIC), JEDEC MS-013, 0.300 Wide
Package Number M20B**

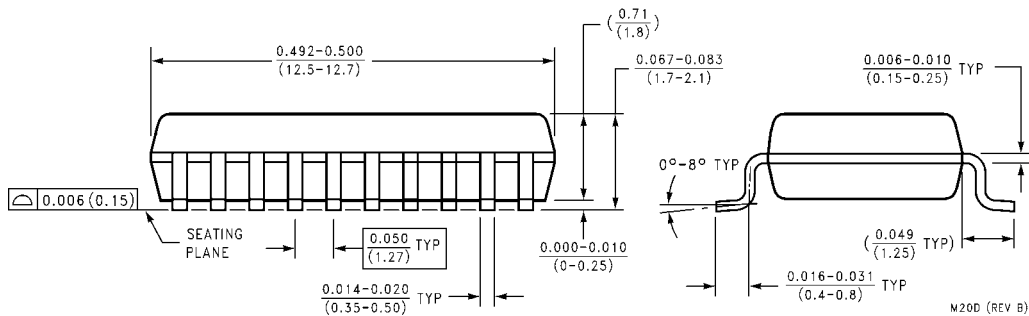
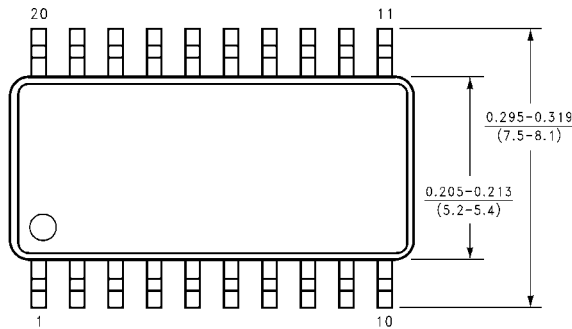

M20D (REV B)

**20-Lead Small Outline Package (SOP), EIAJ TYPE II, 5.3mm Wide
Package Number M20D**

Physical Dimensions inches (millimeters) unless otherwise noted (Continued)

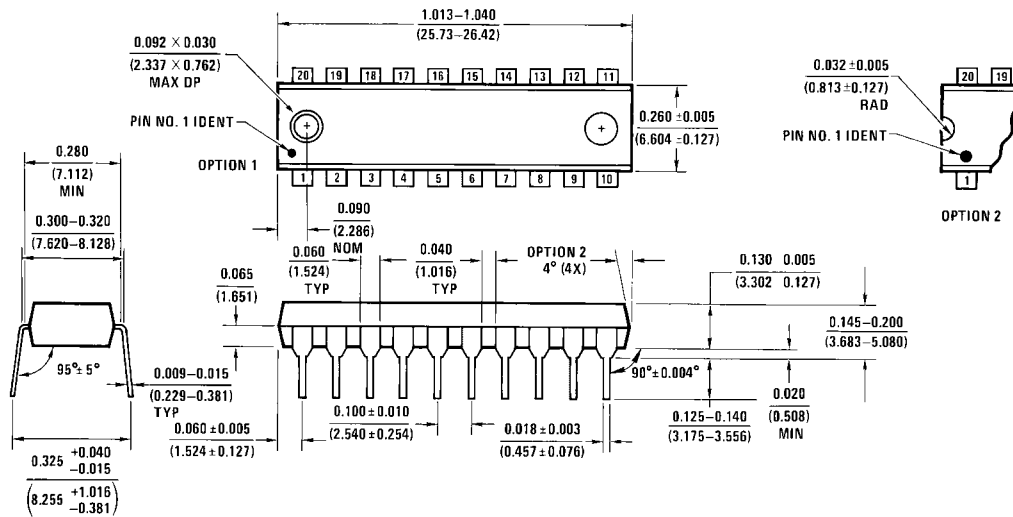

20-Lead Plastic Dual-In-Line Package (PDIP), JEDEC MS-001, 0.300 Wide Package Number N20A

Fairchild does not assume any responsibility for use of any circuitry described, no circuit patent licenses are implied and Fairchild reserves the right at any time without notice to change said circuitry and specifications.

LIFE SUPPORT POLICY

FAIRCHILD'S PRODUCTS ARE NOT AUTHORIZED FOR USE AS CRITICAL COMPONENTS IN LIFE SUPPORT DEVICES OR SYSTEMS WITHOUT THE EXPRESS WRITTEN APPROVAL OF THE PRESIDENT OF FAIRCHILD SEMICONDUCTOR CORPORATION. As used herein:

1. Life support devices or systems are devices or systems which, (a) are intended for surgical implant into the body, or (b) support or sustain life, and (c) whose failure to perform when properly used in accordance with instructions for use provided in the labeling, can be reasonably expected to result in a significant injury to the user.
2. A critical component in any component of a life support device or system whose failure to perform can be reasonably expected to cause the failure of the life support device or system, or to affect its safety or effectiveness.

www.fairchildsemi.com