

**EVALUATION KIT  
AVAILABLE**

# MAXIM

## Upstream CATV Amplifiers

MAX3514/MAX3516/MAX3517

### General Description

The MAX3514/MAX3516/MAX3517 programmable-gain amplifiers are designed for use in CATV upstream applications. The MAX3514/MAX3517 drive up to +61dBmV (QPSK) into a 75Ω load when driven with a +34dBmV nominal input signal. The MAX3516 drives up to +64dBmV (QPSK). Both input and output ports are differential, requiring that an external balun be used at the output port. The variable gain feature provides greater than 56dB of dynamic range, which is controlled by an SPI™ 3-wire interface. Gain control is available in 0.5dB steps. The devices operate over a frequency range of 5MHz to 65MHz.

The MAX3514 is a pin-for-pin compatible upgrade for the MAX3510. Like the MAX3510, the MAX3514 is internally matched for use with a 2:1 (voltage ratio) balun. The MAX3517 utilizes an external output resistor for greater load-matching flexibility, and offers the same performance as the MAX3514. The MAX3516 is a higher power version of the MAX3514 with 3dB more gain and output power capability, and is offered in a smaller thermally enhanced TSSOP-EP package.

These devices operate from a single +5VDC supply and draw 120mA during transmit (100% duty cycle, +61dBmV out). The MAX3516 can be operated at up to +9VDC supply for improved harmonic distortion performance. The bias current is automatically adjusted based on the output level to increase efficiency. Additionally, the devices are shut off between bursts to minimize noise and save power while still maintaining a match at the output port. Shutdown mode disables all circuitry and reduces current consumption to 10μA (typ).

The MAX3514/MAX3517 are available in a 20-pin QSOP package and the MAX3516 is available in a 20-pin TSSOP-EP package. All devices operate in the extended industrial temperature range (-40°C to +85°C).

### Applications

DOCSIS™/EuroDOCSIS™ and DVB Cable Modems  
OpenCable™ Set-Top Box  
Telephony over Cable  
CATV Status Monitor

**Typical Operating Circuit appears at end of data sheet.**

*SPI is a trademark of Motorola Corp.*

*DOCSIS/EuroDOCSIS/OpenCable are trademarks of CableLabs.*

### Features

- ◆ Accurate Gain Control
- ◆ Gain Programmable in 0.5dB Steps
- ◆ 56dB of Gain Control Range
- ◆ -55dBc Harmonic Distortion at 65MHz Input
- ◆ Low Burst On/Off Transient
- ◆ High Efficiency:
  - 35mA at +34dBmV Out
  - 8mA Transmit Disable Mode

### Ordering Information

PART	TEMP RANGE	PIN-PACKAGE
MAX3514EEP	-40°C to +85°C	20 QSOP
MAX3516EUP	-40°C to +85°C	20 TSSOP-EP*
MAX3517EEP	-40°C to +85°C	20 QSOP

\*Exposed paddle

### Pin Configuration

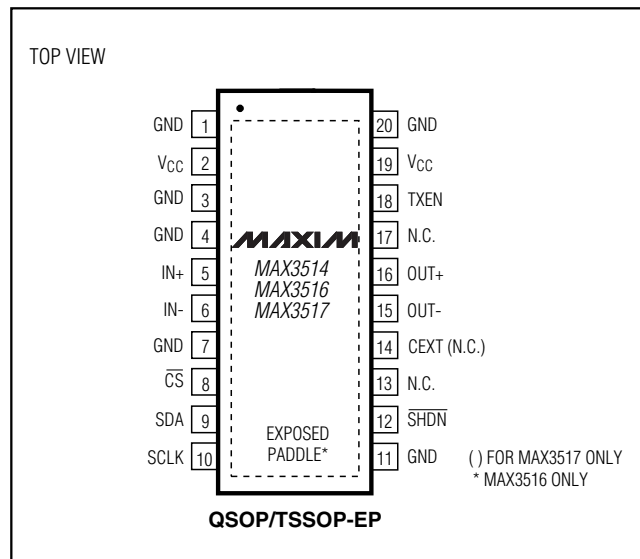

**MAXIM**

Maxim Integrated Products 1

**For pricing, delivery, and ordering information, please contact Maxim/Dallas Direct! at 1-888-629-4642, or visit Maxim's website at [www.maxim-ic.com](http://www.maxim-ic.com).**

# Upstream CATV Amplifiers

## ABSOLUTE MAXIMUM RATINGS

V <sub>CC</sub> , OUT+, OUT-.....	-0.3V to +10.0V	Operating Temperature Range .....	-40°C to +85°C
Input Voltage Levels (all inputs).....	-0.3V to (V <sub>CC</sub> + 0.3V)	Junction Temperature .....	+150°C
Continuous Input Voltage (IN+, IN-).....	2Vp-p	Storage Temperature Range .....	-65°C to +150°C
Continuous Current (OUT+, OUT-) .....	120mA	Lead Temperature (soldering, 10s) .....	+300°C
Continuous Power Dissipation (T <sub>A</sub> = +70°C)			
20-Pin QSOP (derate 12.3mW/°C above T <sub>A</sub> = +70°C) ..	.988mW		
20-Pin TSSOP-EP			
(derate 27mW/°C above T <sub>A</sub> = +70°C) .....	.2200mW		

Stresses beyond those listed under "Absolute Maximum Ratings" may cause permanent damage to the device. These are stress ratings only, and functional operation of the device at these or any other conditions beyond those indicated in the operational sections of the specifications is not implied. Exposure to absolute maximum rating conditions for extended periods may affect device reliability.

## DC ELECTRICAL CHARACTERISTICS—MAX3514/MAX3516/MAX3517

(Typical operating circuit; V<sub>CC</sub> = +4.75V to +5.25V, V<sub>GND</sub> = 0, TXEN =  $\overline{\text{SHDN}}$  = high, T<sub>A</sub> = -40°C to +85°C. Typical parameters are at V<sub>CC</sub> = +5V, T<sub>A</sub> = +25°C, unless otherwise specified.) (Note 1)

PARAMETER	SYMBOL	CONDITIONS	MIN	TYP	MAX	UNITS
Supply Voltage	V <sub>CC</sub>		4.75		5.25	V
Supply Current Transmit Mode (MAX3514/MAX3517)	I <sub>CC</sub>	D7 = 1, gain code = 125 (A <sub>V</sub> = 27dB)		120	150	mA
		D7 = 0, gain code = 100 (A <sub>V</sub> = 0dB)		35		
Supply Current Transmit Mode (MAX3516)	I <sub>CC</sub>	D7 = 1, gain code = 125 (A <sub>V</sub> = 31dB)		160	195	mA
		D7 = 0, gain code = 94 (A <sub>V</sub> = 0.5dB)		30		
Supply Current Transmit Disable Mode	I <sub>CC</sub>	TXEN = low		8	12	mA
Supply Current Low-Power Standby	I <sub>CC</sub>	$\overline{\text{SHDN}}$ = low		10		μA
<b>LOGIC INPUTS</b>						
Input High Voltage	V <sub>INH</sub>		2.0			V
Input Low Voltage	V <sub>INL</sub>				0.8	V
Input High Current	I <sub>BIASH</sub>	V <sub>INH</sub> = +3.6V			100	μA
Input Low Current	I <sub>BIASL</sub>	V <sub>INL</sub> = 0	-100			μA

# Upstream CATV Amplifiers

MAX3514/MAX3516/MAX3517

## AC ELECTRICAL CHARACTERISTICS—MAX3514

(MAX3514 EV kit;  $V_{CC} = +4.75V$  to  $+5.25V$ ,  $V_{GND} = 0$ ,  $P_{IN} = +34dBmV$ ,  $TXEN = \overline{SHDN} = \text{high}$ ,  $T_A = -40^{\circ}C$  to  $+85^{\circ}C$ . Typical parameters are at  $V_{CC} = +5V$ ,  $T_A = +25^{\circ}C$ , unless otherwise specified.) (Note 1)

PARAMETER	SYMBOL	CONDITIONS	MIN	TYP	MAX	UNITS
Voltage Gain, $f_{IN} = 5MHz$ (Note 2)	$A_V$	D7 = 1, gain code = 125, $T_A = 0^{\circ}C$ to $+85^{\circ}C$	26.7	27.7	28.7	dB
		D7 = 1, gain code = 110, $T_A = 0^{\circ}C$ to $+85^{\circ}C$	19.2	20.2	21.2	
		D7 = 1, gain code = 87, $T_A = 0^{\circ}C$ to $+85^{\circ}C$	7.7	8.7	9.7	
		D7 = 0, gain code = 115, $T_A = 0^{\circ}C$ to $+85^{\circ}C$	6.7	7.7	8.7	
		D7 = 0, gain code = 100, $T_A = 0^{\circ}C$ to $+85^{\circ}C$	-0.8	0.2	1.2	
		D7 = 0, gain code = 80, $T_A = 0^{\circ}C$ to $+85^{\circ}C$	-10.8	-9.8	-8.8	
		D7 = 0, gain code = 60, $T_A = 0^{\circ}C$ to $+85^{\circ}C$	-20.8	-19.8	-18.8	
Voltage Gain, $f_{IN} = 65MHz$	$A_V$	D7 = 1, gain code = 127, $T_A = -40^{\circ}C$ to $+85^{\circ}C$ ; Notes 3, 4	26.3			dB
Gain Rolloff		$V_{OUT} = 61dBmV$ , $f_{IN} = 5MHz$ to $42MHz$ (Notes 3, 4)		-0.3	-0.5	dB
		$V_{OUT} = 61dBmV$ , $f_{IN} = 5MHz$ to $65MHz$ (Notes 3, 4)		-1.0	-1.5	
Gain Step Size		$f_{IN} = 5MHz$ to $65MHz$ , $A_V = -26dB$ to $+27dB$		0.5		dB
		$f_{IN} = 5MHz$ to $65MHz$ , $A_V = -26dB$ to $+27dB$ , any 2-bit transition of D0, D1	0.7	1	1.3	
		$f_{IN} = 5MHz$ to $65MHz$ , D7 = 0, gain code = 115; to D7 = 1, gain code = 87	0.7	1.0	1.3	
Transmit-Disable Mode Noise		$TXEN = \text{low}$ , $BW = 160kHz$ , $f_{IN} = 5MHz$ to $65MHz$ ; Note 3			-71	dBmV
Isolation in Transmit-Disable Mode		$TXEN = \text{low}$ , $f_{IN} = 5MHz$ to $65MHz$ (Note 3)	60			dB
Transmit Mode Noise		$BW = 160kHz$ , $f_{IN} = 5MHz$ to $65MHz$ , $A_V = -26dB$ to $+27dB$ ; Note 3			-59	dBc
Transmit Enable Transient Duration		$TXEN$ input rise/fall time $< 0.1\mu s$ , $T_A = +25^{\circ}C$ (Note 3)			2	$\mu s$
Transmit Disable Transient Duration		$TXEN$ input rise/fall time $< 0.1\mu s$ , $T_A = +25^{\circ}C$ (Note 3)			2	$\mu s$
Transmit Disable/Transmit Enable Transient Step Size		D7 = 1, gain code = 125 ( $A_V = 27dB$ ), $T_A = +25^{\circ}C$		30	100	mVp-p
		D7 = 0, gain code = 100 ( $A_V = 0.2dB$ ), $T_A = +25^{\circ}C$		1		
Input Impedance	$Z_{IN}$	$f_{IN} = 5MHz$ to $65MHz$ , single ended; Note 3	1	1.5		k $\Omega$
Output Return Loss		$f_{IN} = 5MHz$ to $42MHz$ in $75\Omega$ system, D7 = 1 gain code = 125 ( $A_V = 27dB$ ) (Note 4)		10		dB

# Upstream CATV Amplifiers

MAX3514/MAX3516/MAX3517

## AC ELECTRICAL CHARACTERISTICS—MAX3514 (continued)

(MAX3514 EV kit;  $V_{CC} = +4.75V$  to  $+5.25V$ ,  $V_{GND} = 0$ ,  $P_{IN} = +34dBmV$ ,  $TXEN = \overline{SHDN} = \text{high}$ ,  $T_A = -40^\circ C$  to  $+85^\circ C$ . Typical parameters are at  $V_{CC} = +5V$ ,  $T_A = +25^\circ C$ , unless otherwise specified.) (Note 1)

PARAMETER	SYMBOL	CONDITIONS	MIN	TYP	MAX	UNITS
Output Return Loss in Transmit-Disable Mode		$f_{IN} = 5MHz$ to $42MHz$ , in $75\Omega$ system, $TXEN = \text{low}$ ; Note 4		10		dB
Two-Tone Third-Order Distortion	IM3	Input tones at $42MHz$ and $42.2MHz$ , both $+31dBmV$ , $V_{OUT} = +58dBmV/\text{tone}$ ; Note 3		-53	-47	dBc
		Input tones at $65MHz$ and $65.2MHz$ , both $+31dBmV$ , $V_{OUT} = +58dBmV/\text{tone}$		-49		
2nd-Harmonic Distortion	HD2	$f_{IN} = 33MHz$ , $V_{OUT} = +61dBmV$ ; Note 3		-55	-53	dBc
		$f_{IN} = 65MHz$ , $V_{OUT} = +61dBmV$ ; Note 3		-55	-52	
3rd-Harmonic Distortion	HD3	$f_{IN} = 22MHz$ , $V_{OUT} = +61dBmV$		-55	-50.5	dBc
		$f_{IN} = 65MHz$ , $V_{OUT} = +61dBmV$		-55	-50.5	
AM to AM	AM/AM	$A_V = 27dB$ , $V_{IN} = +34dBmV$ to $+38dBmV$ , $f_{IN} = 42MHz$		0.1		dB
		$A_V = 27dB$ , $V_{IN} = +34dBmV$ to $+38dBmV$ , $f_{IN} = 65MHz$		0.1		
AM to PM	AM/PM	$A_V = 27dB$ , $V_{IN} = +34dBmV$ to $+38dBmV$ , $f_{IN} = 42MHz$		1		degrees
		$A_V = 27dB$ , $V_{IN} = +34dBmV$ to $+38dBmV$ , $f_{IN} = 65MHz$		1		

# Upstream CATV Amplifiers

MAX3514/MAX3516/MAX3517

## AC ELECTRICAL CHARACTERISTICS—MAX3516

(MAX3516 EV kit;  $V_{CC} = +4.75V$  to  $+5.25V$ ,  $V_{GND} = 0$ ,  $P_{IN} = +34dBmV$ ,  $TXEN = \overline{SHDN} = \text{high}$ ,  $T_A = -40^{\circ}C$  to  $+85^{\circ}C$ . Typical parameters are at  $V_{CC} = +5V$ ,  $T_A = +25^{\circ}C$ , unless otherwise specified.) (Note 1)

PARAMETER	SYMBOL	CONDITIONS	MIN	TYP	MAX	UNITS
Voltage Gain, $f_{IN} = 5MHz$ (Note 2)	$A_V$	D7 = 1, gain code = 125, $T_A = 0^{\circ}C$ to $+85^{\circ}C$	30	31	32	dB
		D7 = 1, gain code = 119, $T_A = 0^{\circ}C$ to $+85^{\circ}C$	27	28	29	
		D7 = 1, gain code = 104, $T_A = 0^{\circ}C$ to $+85^{\circ}C$	19.5	20.5	21.5	
		D7 = 1, gain code = 81, $T_A = 0^{\circ}C$ to $+85^{\circ}C$	8	9	10	
		D7 = 0, gain code = 109, $T_A = 0^{\circ}C$ to $+85^{\circ}C$	7	8	9	
		D7 = 0, gain code = 94, $T_A = 0^{\circ}C$ to $+85^{\circ}C$	-0.5	0.5	1.5	
		D7 = 0, gain code = 74, $T_A = 0^{\circ}C$ to $+85^{\circ}C$	-10.5	-9.5	-8.5	
		D7 = 0, gain code = 54, $T_A = 0^{\circ}C$ to $+85^{\circ}C$	-20.5	-19.5	-18.5	
		D7 = 0, gain code = 42, $T_A = 0^{\circ}C$ to $+85^{\circ}C$	-26.5	-25.5	-24.5	
Voltage Gain, $f_{IN} = 65MHz$	$A_V$	D7 = 1, gain code = 127, $T_A = -40^{\circ}C$ to $+85^{\circ}C$ (Notes 3, 4)	28.1			dB
Gain Rolloff		$V_{OUT} = 64dBmV$ , $f_{IN} = 5MHz$ to $42MHz$ (Notes 3, 4)		-0.3	-0.6	dB
		$V_{OUT} = 64dBmV$ , $f_{IN} = 5MHz$ to $65MHz$ (Notes 3, 4)		-1.1	-1.7	
Gain Step Size		$f_{IN} = 5MHz$ to $65MHz$ , $A_V = -26dB$ to $+30dB$		0.5		dB
		$f_{IN} = 5MHz$ to $65MHz$ , $A_V = -26dB$ to $+30dB$ , any 2-bit transition of D0, D1	0.7	1.0	1.3	
		$f_{IN} = 5MHz$ to $42MHz$ , $A_V = -26dB$ to $+30dB$ , D7 = 0, gain code = 109; to D7 = 1, gain code = 81	0.7	1.0	1.3	
Transmit-Disable Mode Noise		$TXEN = \text{low}$ , $BW = 160kHz$ , $f_{IN} = 5MHz$ to $65MHz$			-71	dBmV
Isolation in Transmit-Disable Mode		$TXEN = \text{low}$ , $f_{IN} = 5MHz$ to $65MHz$ (Note 3)	60			dB
Transmit Mode Noise		$BW = 160kHz$ , $f_{IN} = 5MHz$ to $65MHz$ , $A_V = -26dB$ to $27dB$ (Note 3)			-59	dBc

# Upstream CATV Amplifiers

MAX3514/MAX3516/MAX3517

## AC ELECTRICAL CHARACTERISTICS—MAX3516 (continued)

(MAX3516 EV kit;  $V_{CC} = +4.75V$  to  $+5.25V$ ,  $V_{GND} = 0$ ,  $P_{IN} = +34dBmV$ ,  $TXEN = \overline{SHDN} = \text{high}$ ,  $T_A = -40^\circ C$  to  $+85^\circ C$ . Typical parameters are at  $V_{CC} = +5V$ ,  $T_A = +25^\circ C$ , unless otherwise specified.) (Note 1)

PARAMETER	SYMBOL	CONDITIONS	MIN	TYP	MAX	UNITS
Transmit Enable Transient Duration		TXEN input rise/fall time $< 0.1\mu s$ , $T_A = +25^\circ C$ (Note 3)			2	$\mu s$
Transmit Disable Transient Duration		TXEN input rise/fall time $< 0.1\mu s$ , $T_A = +25^\circ C$ (Note 3)			2	$\mu s$
Transmit Disable/Transmit Enable Transient Step Size		D7 = 1, gain code = 119, ( $A_V = 28dB$ ), $T_A = +25^\circ C$		30	100	mVp-p
		D7 = 0, gain code = 94, ( $A_V = 0.5dB$ ), $T_A = +25^\circ C$		1		
Input Impedance	$Z_{IN}$	$f_{IN} = 5MHz$ to $65MHz$ , single-ended (Note 3)	1	1.5		$k\Omega$
Output Return Loss		$f_{IN} = 5MHz$ to $65MHz$ in $75\Omega$ system D7 = 1, gain code = 125, ( $A_V = 31dB$ ) (Note 4)		10		dB
Output Return Loss in Transmit-Disable Mode		$f_{IN} = 5MHz$ to $65MHz$ in $75\Omega$ system, TXEN = low (Note 4)		10		dB
Two-Tone Third-Order Distortion (Note 3)	IM3	Input tones at $42MHz$ and $42.2MHz$ , both $+31dBmV$ , $V_{OUT} = +58dBmV/\text{tone}$		-53.5		dBc
		Input tones at $65MHz$ and $65.2MHz$ , both $+31dBmV$ , $V_{OUT} = +58dBmV/\text{tone}$		-48.8		
2nd-Harmonic Distortion (Note 3)	HD2	$f_{IN} = 33MHz$ , $V_{OUT} = +61dBmV$		-55	-53	dBc
		$f_{IN} = 33MHz$ , $V_{OUT} = +64dBmV$		-55		
		$f_{IN} = 65MHz$ , $V_{OUT} = +61dBmV$		-55	-52	
3rd-Harmonic Distortion	HD3	$f_{IN} = 22MHz$ , $V_{OUT} = +61dBmV$		-55	-50.5	dBc
		$f_{IN} = 22MHz$ , $V_{OUT} = +64dBmV$		-50		
		$f_{IN} = 65MHz$ , $V_{OUT} = +61dBmV$		-55	-50.5	
AM to AM	AM/AM	$A_V = 27dB$ , $V_{IN} = +34dBmV$ to $+38dBmV$ , $f_{IN} = 42MHz$		0.1		dB
AM to AM	AM/AM	$A_V = 27dB$ , $V_{IN} = +34dBmV$ to $+38dBmV$ , $f_{IN} = 65MHz$		0.1		dB
AM to PM	AM/PM	$A_V = 27dB$ , $V_{IN} = +34dBmV$ to $+38dBmV$ , $f_{IN} = 42MHz$		1		degrees
AM to PM	AM/PM	$A_V = 27dB$ , $V_{IN} = +34dBmV$ to $+38dBmV$ , $f_{IN} = 65MHz$		1		degrees

# Upstream CATV Amplifiers

MAX3514/MAX3516/MAX3517

## AC ELECTRICAL CHARACTERISTICS—MAX3517

(MAX3517 EV kit;  $V_{CC} = +4.75V$  to  $+5.25V$ ,  $V_{GND} = 0$ ,  $P_{IN} = +34dBmV$ ,  $TXEN = \overline{SHDN} = \text{high}$ ,  $T_A = -40^{\circ}C$  to  $+85^{\circ}C$ . Typical parameters are at  $V_{CC} = +5V$ ,  $T_A = +25^{\circ}C$ , unless otherwise specified.) (Note 1)

PARAMETER	SYMBOL	CONDITIONS	MIN	TYP	MAX	UNITS
Voltage Gain, $f_{IN} = 5MHz$	$A_V$	D7 = 1, gain code = 125, $T_A = 0^{\circ}C$ to $+85^{\circ}C$	26.7	27.7	28.7	dB
		D7 = 1, gain code = 110, $T_A = 0^{\circ}C$ to $+85^{\circ}C$	19.2	20.2	21.2	
		D7 = 1, gain code = 90, $T_A = 0^{\circ}C$ to $+85^{\circ}C$	9.2	10.2	11.2	
		D7 = 1, gain code = 70, $T_A = 0^{\circ}C$ to $+85^{\circ}C$	-0.8	0.2	1.2	
		D7 = 1, gain code = 115, $T_A = 0^{\circ}C$ to $+85^{\circ}C$	6.7	7.7	8.7	
		D7 = 1, gain code = 100, $T_A = 0^{\circ}C$ to $+85^{\circ}C$	-0.8	0.2	1.2	
		D7 = 1, gain code = 80, $T_A = 0^{\circ}C$ to $+85^{\circ}C$	-10.8	-9.8	-8.8	
		D7 = 0, gain code = 60, $T_A = 0^{\circ}C$ to $+85^{\circ}C$	-20.8	-19.8	-18.8	
		D7 = 0, gain code = 48, $T_A = 0^{\circ}C$ to $+85^{\circ}C$	-27.0	-26.0	-25.0	
Gain Step Size		$f_{IN} = 5MHz$ to $65MHz$ , $A_V = -26dB$ to $+27dB$		0.5		dB
Transmit-Disable Mode Noise		$TXEN = \text{low}$ , $BW = 160kHz$ , $f_{IN} = 5MHz$ to $65MHz$		-71		dBmV
Isolation in Transmit-Disable Mode		$TXEN = \text{low}$ , $f_{IN} = 5MHz$ to $65MHz$	50	58		dB
Transmit Mode Noise		$BW = 160kHz$ , $f_{IN} = 5MHz$ to $65MHz$ , $A_V = -26dB$ to $+27dB$ ; Note 3		-60	-59	dBc
Transmit Enable Transient Duration		$TXEN$ input rise/fall time $< 0.1\mu s$ , $T_A = +25^{\circ}C$ ; Note 3			2	$\mu s$

# Upstream CATV Amplifiers

MAX3514/MAX3516/MAX3517

## AC ELECTRICAL CHARACTERISTICS—MAX3517 (continued)

(MAX3517 EV kit;  $V_{CC} = +4.75V$  to  $+5.25V$ ,  $V_{GND} = 0$ ,  $P_{IN} = +34dBmV$ ,  $TXEN = \overline{SHDN} = \text{high}$ ,  $T_A = -40^\circ C$  to  $+85^\circ C$ . Typical parameters are at  $V_{CC} = +5V$ ,  $T_A = +25^\circ C$ , unless otherwise specified.) (Note 1)

PARAMETER	SYMBOL	CONDITIONS	MIN	TYP	MAX	UNITS
Transmit Disable Transient Duration		TXEN input rise/fall time $< 0.1\mu s$ , $T_A = +25^\circ C$			2	$\mu s$
Transmit Disable/Transmit Enable Transient Step Size		D7 = 1, gain code = 125, ( $A_V = 27dB$ ), $T_A = +25^\circ C$		30	100	mVp-p
		D7 = 0, gain code = 100, ( $A_V = 0.2 dB$ ), $T_A = +25^\circ C$		1		
Input Impedance	$Z_{IN}$	$f_{IN} = 5MHz$ to $65MHz$ , single ended; Note 3	1	1.5		$k\Omega$
Output Return Loss		$f_{IN} = 5MHz$ to $65MHz$ in $75\Omega$ system D7 = 1, gain code = 125, ( $A_V = 27dB$ ); Note 4		8.3		dB
Output Return Loss in Transmit-Disable Mode		$f_{IN} = 42MHz$ , in $75\Omega$ system TXEN = low; Note 4		10.5		dB
Two-Tone Third-Order Distortion (Note 2)	IM3	Input tones at $42MHz$ and $42.2MHz$ , both $+31dBmV$ , $V_{OUT} = +58dBmV/\text{tone}$		-49.5		dBc
		Input tones at $65MHz$ and $65.2MHz$ , both $+31dBmV$ , $V_{OUT} = +58dBmV/\text{tone}$		-46.3		
2nd-Harmonic Distortion	HD2	$f_{IN} = 33MHz$ , $V_{OUT} = +61dBmV$		-55		dBc
		$f_{IN} = 65MHz$ , $V_{OUT} = +61dBmV$		-55		
3rd-Harmonic Distortion	HD3	$f_{IN} = 22MHz$ , $V_{OUT} = +61dBmV$		-55		dBc
		$f_{IN} = 65MHz$ , $V_{OUT} = +61dBmV$		-55		
AM to AM	AM/AM	$A_V = 27dB$ , $V_{IN} = +34dBmV$ to $+38dBmV$ , $f_{IN} = 42MHz$		0.1		dB
AM to AM	AM/AM	$A_V = 27dB$ , $V_{IN} = +34dBmV$ to $+38dBmV$ , $f_{IN} = 65MHz$		0.1		dB
AM to PM	AM/PM	$A_V = 27dB$ , $V_{IN} = +34dBmV$ to $+38dBmV$ , $f_{IN} = 42MHz$		1		degrees
AM to PM	AM/PM	$A_V = 27dB$ , $V_{IN} = +34dBmV$ to $+38dBmV$ , $f_{IN} = 65MHz$		1		degrees



# Upstream CATV Amplifiers

MAX3514/MAX3516/MAX3517

## TIMING CHARACTERISTICS

(V<sub>CC</sub> = 4.75V to 5.25V, V<sub>GND</sub> = 0, TXEN =  $\overline{\text{SHDN}}$  = high, D7 = X, T<sub>A</sub> = +25°C, unless otherwise specified.)

PARAMETER	SYMBOL	CONDITIONS	MIN	TYP	MAX	UNITS
SEN to SCLK Setup Time	t <sub>SENS</sub>		20			ns
SEN to SCLK Hold Time	t <sub>SENH</sub>		10			ns
SDA to SCLK Setup Time	t <sub>SDAS</sub>		10			ns
SDA to SCLK Hold Time	t <sub>SDAH</sub>		20			ns
SDA Pulse Width High	T <sub>DATAH</sub>		50			ns
SDA Pulse Width Low	T <sub>DATAL</sub>		50			ns
SCLK Pulse Width High	t <sub>SCLKH</sub>		50			ns
SCLK Pulse Width Low	t <sub>SCLKL</sub>		50			ns

**Note 1:** Guaranteed by design and characterization to ±3 sigma for T<sub>A</sub> < +25°C, unless otherwise specified.

**Note 2:** AC Gain correlated to DC Gain measurements to ±3 sigma.

**Note 3:** Guaranteed by design and characterization to ±6 sigma.

**Note 4:** Does not include output matching; see Output Match in the *Applications* section.

## Typical Operating Characteristics

(Typical operating circuit; V<sub>CC</sub> = +5V, V<sub>IN</sub> = +34dBmV, TXEN =  $\overline{\text{SHDN}}$  = high, f<sub>IN</sub> = 20MHz, Z<sub>LOAD</sub> = 75Ω, T<sub>A</sub> = +25°C, unless otherwise noted.)

### MAX3514/MAX3517

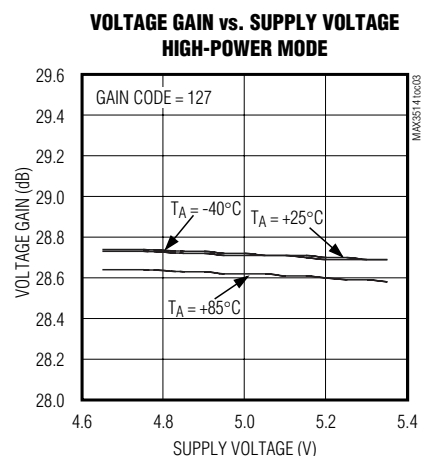
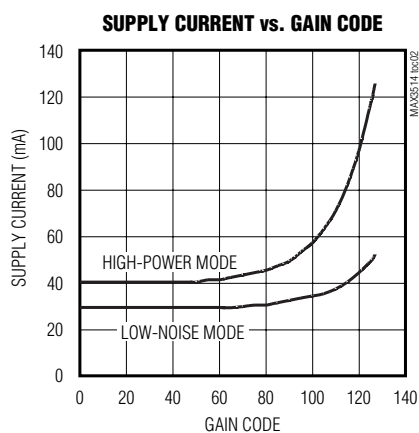
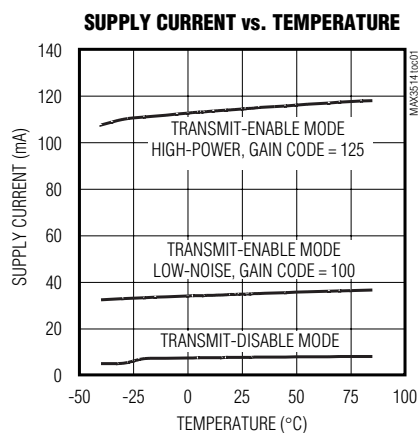

# Upstream CATV Amplifiers

## Typical Operating Characteristics (continued)

(Typical operating circuit;  $V_{CC} = +5V$ ,  $V_{IN} = +34dBmV$ ,  $TXEN = \overline{SHDN} = \text{high}$ ,  $f_{IN} = 20MHz$ ,  $Z_{LOAD} = 75\Omega$ ,  $T_A = +25^\circ C$ , unless otherwise noted.)

### MAX3514/MAX3517 (continued)

**VOLTAGE GAIN vs. SUPPLY VOLTAGE  
LOW-NOISE MODE**

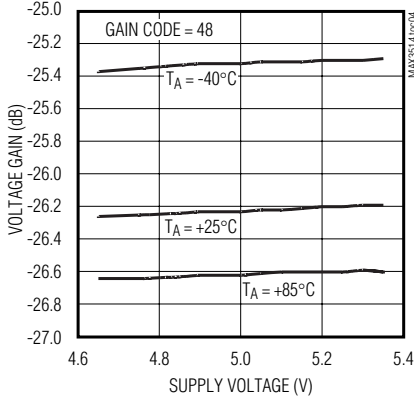

**VOLTAGE GAIN vs. TEMPERATURE  
HIGH-POWER MODE**

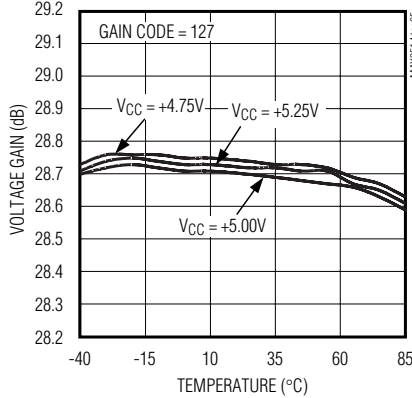

**VOLTAGE GAIN vs. TEMPERATURE  
LOW-NOISE MODE**

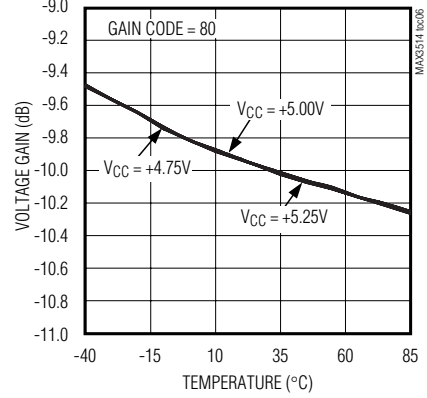

**VOLTAGE GAIN vs. FREQUENCY  
HIGH-POWER MODE**

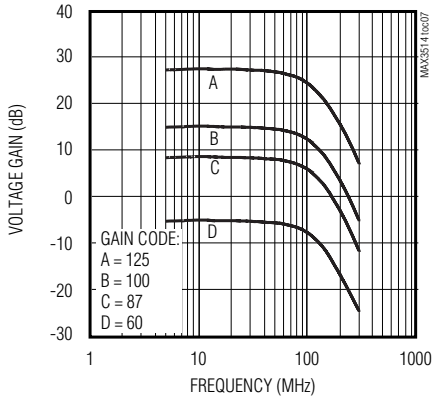

**VOLTAGE GAIN vs. FREQUENCY  
LOW-NOISE MODE**

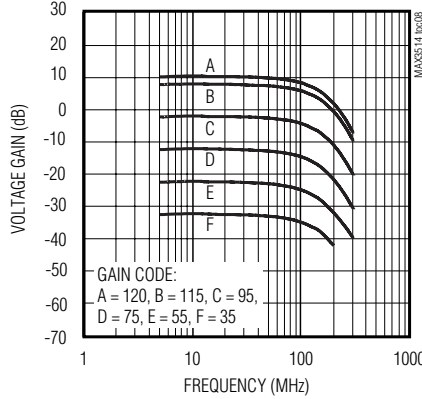

**VOLTAGE GAIN vs. GAIN CODE**

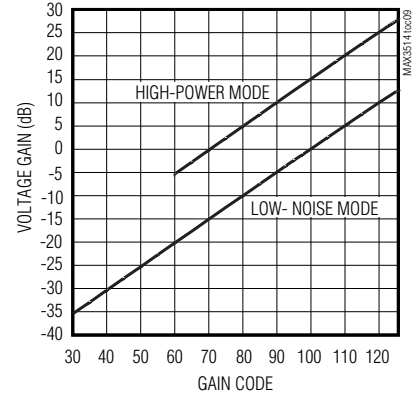

**GAIN STEP vs. GAIN CODE  
HIGH-POWER MODE**

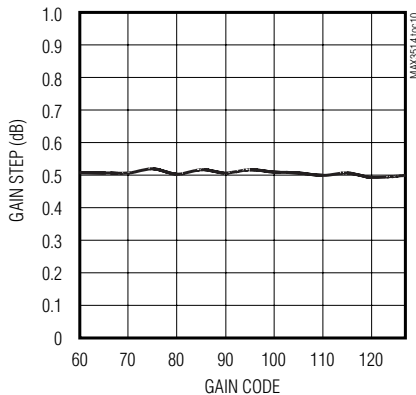

**GAIN STEP vs. GAIN CODE  
LOW-NOISE MODE**

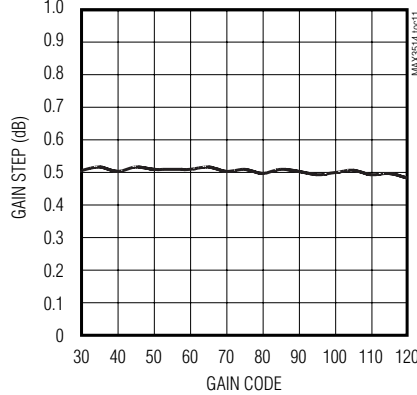

**TRANSMIT NOISE vs. GAIN CODE**

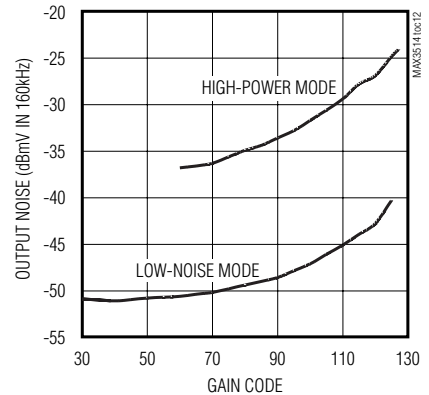

# Upstream CATV Amplifiers

## Typical Operating Characteristics (continued)

(Typical operating circuit;  $V_{CC} = +5V$ ,  $V_{IN} = +34dBmV$ ,  $TXEN = \overline{SHDN} = \text{high}$ ,  $f_{IN} = 20MHz$ ,  $Z_{LOAD} = 75\Omega$ ,  $T_A = +25^\circ C$ , unless otherwise noted.)

### MAX3514/MAX3517 (continued)

MAX3514/MAX3516/MAX3517

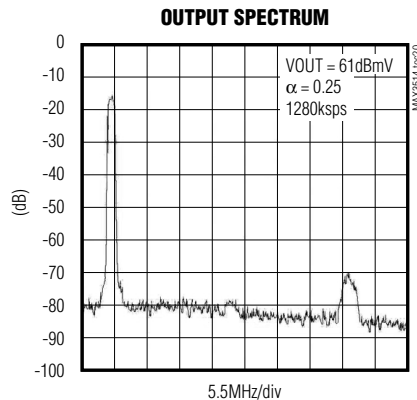
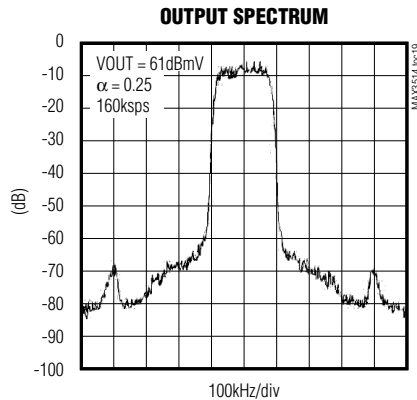
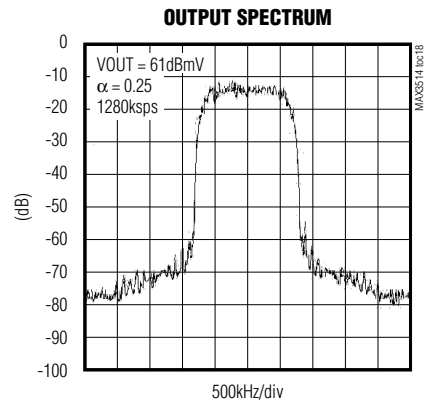
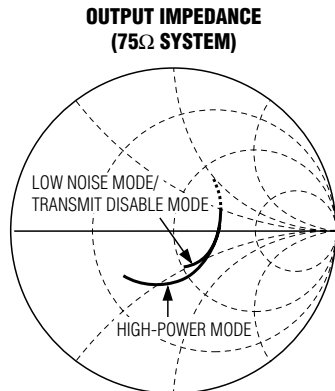
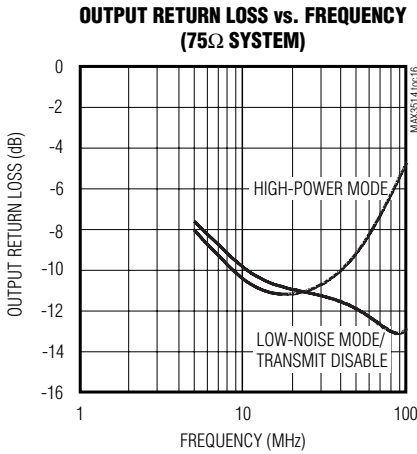
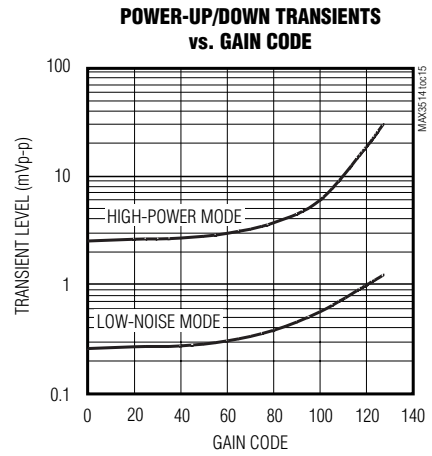
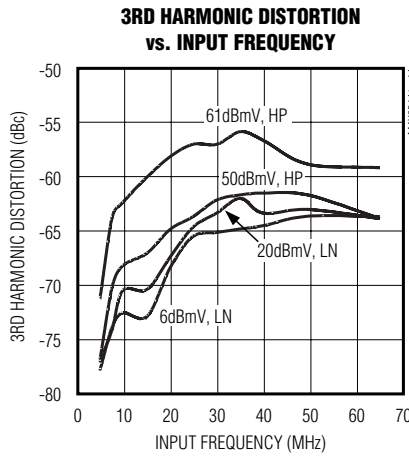
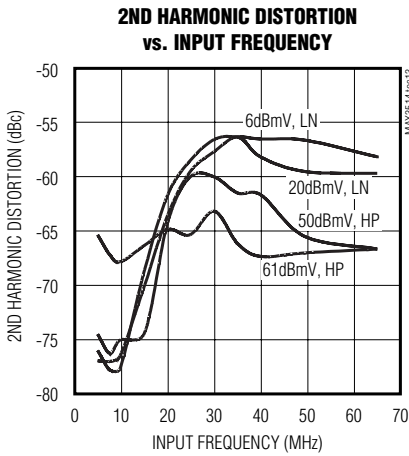

# Upstream CATV Amplifiers

## Typical Operating Characteristics (continued)

(Typical operating circuit;  $V_{CC} = +5V$ ,  $V_{IN} = +34dBmV$ ,  $TXEN = \overline{SHDN} = \text{high}$ ,  $f_{IN} = 20MHz$ ,  $Z_{LOAD} = 75\Omega$ ,  $T_A = +25^\circ C$ , unless otherwise noted.)

### MAX3516

**SUPPLY CURRENT vs. TEMPERATURE**

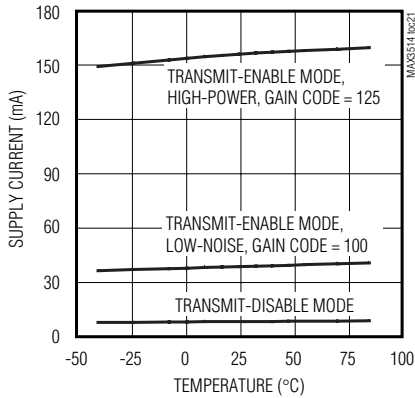

**SUPPLY CURRENT vs. GAIN CODE**

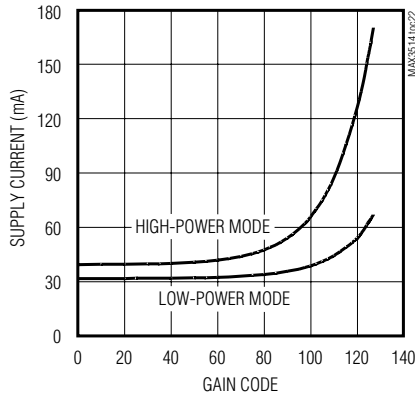

**VOLTAGE GAIN vs. SUPPLY VOLTAGE HIGH-POWER MODE**

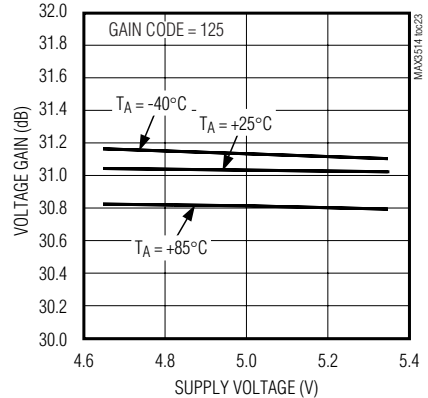

**VOLTAGE GAIN vs. SUPPLY VOLTAGE LOW-NOISE MODE**

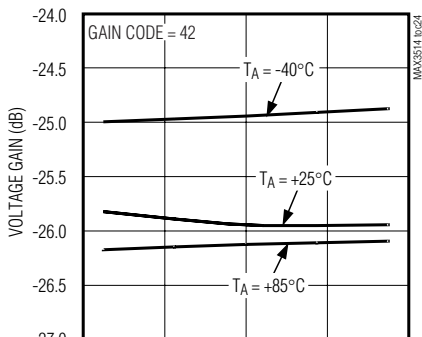

**VOLTAGE GAIN vs. TEMPERATURE HIGH-POWER MODE**

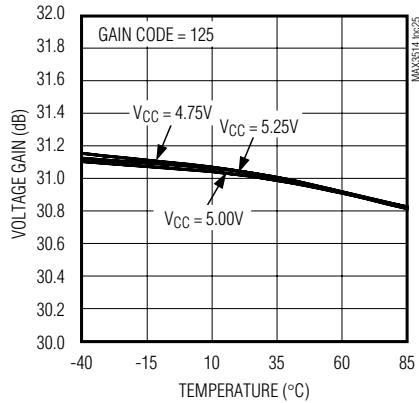

**VOLTAGE GAIN vs. TEMPERATURE LOW-NOISE MODE**

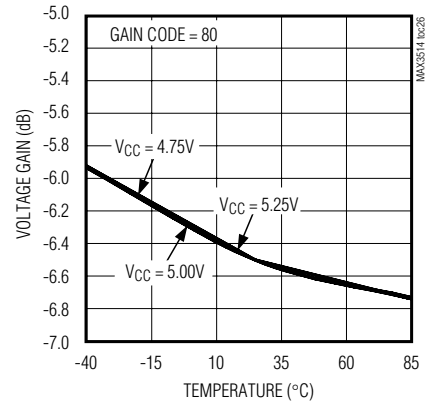

**VOLTAGE GAIN vs. FREQUENCY HIGH-POWER MODE**

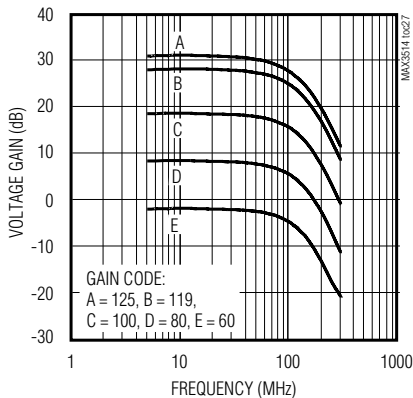

**VOLTAGE GAIN vs. FREQUENCY LOW-NOISE MODE**

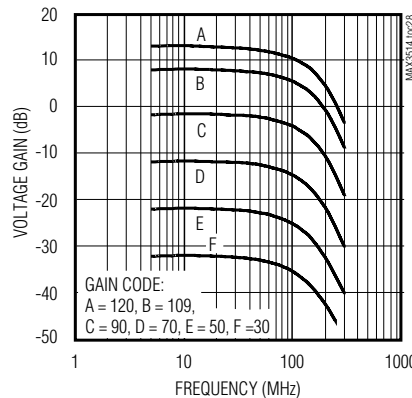

**VOLTAGE GAIN vs. GAIN MODE**

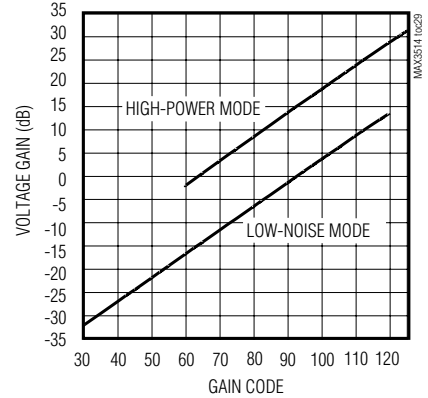

# Upstream CATV Amplifiers

## Typical Operating Characteristics (continued)

(Typical operating circuit;  $V_{CC} = +5V$ ,  $V_{IN} = +34dBmV$ ,  $TXEN = \overline{SHDN} = \text{high}$ ,  $f_{IN} = 20MHz$ ,  $Z_{LOAD} = 75\Omega$ ,  $T_A = +25^\circ C$ , unless otherwise noted.)

MAX3514/MAX3516/MAX3517

### MAX3516 (continued)

**GAIN STEP vs. GAIN MODE  
HIGH-POWER MODE**

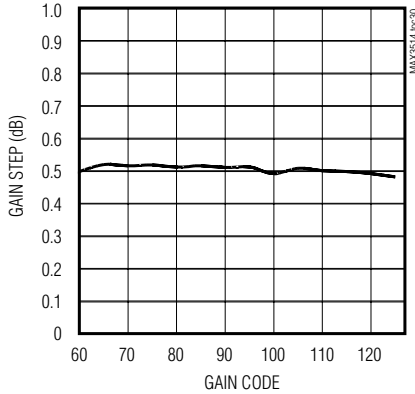

**GAIN STEP vs. GAIN CODE  
LOW-NOISE MODE**

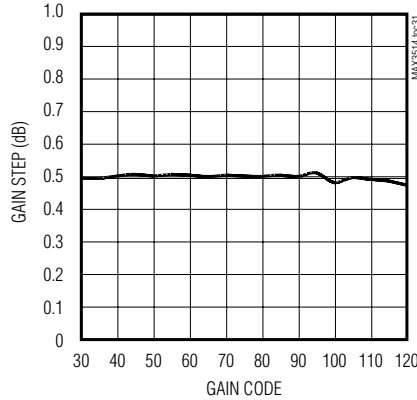

**TRANSMIT NOISE vs. GAIN CODE**

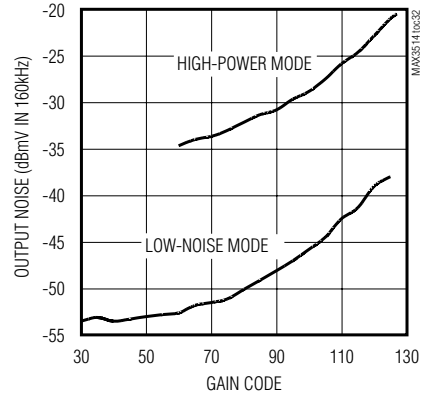

**2ND HARMONIC DISTORTION  
vs. INPUT FREQUENCY,  $V_{CC} = 5.0V$**

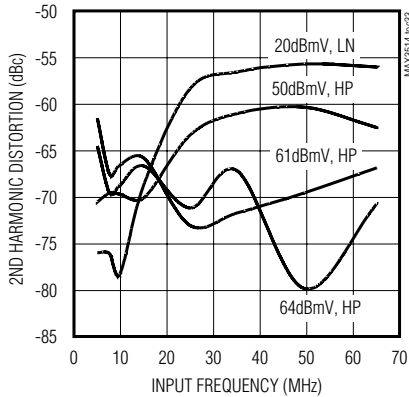

**3RD HARMONIC DISTORTION  
vs. INPUT FREQUENCY,  $V_{CC} = 5.0V$**

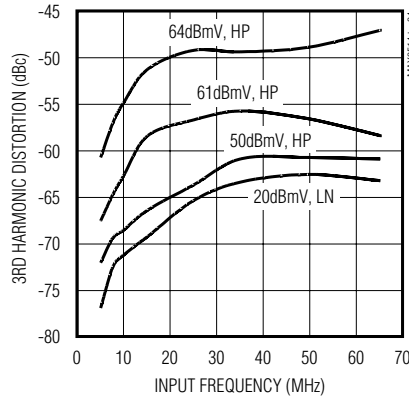

**2ND HARMONIC DISTORTION  
vs. INPUT FREQUENCY,  $V_{CC} = 7.0V$**

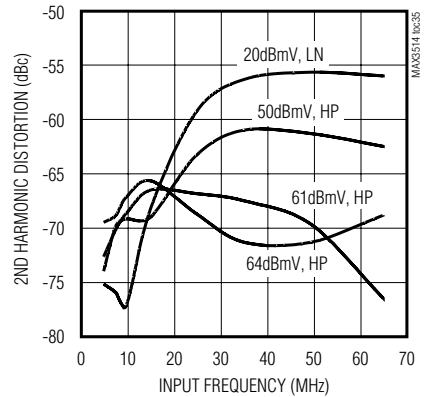

**3RD HARMONIC DISTORTION  
vs. INPUT FREQUENCY,  $V_{CC} = 7.0V$**

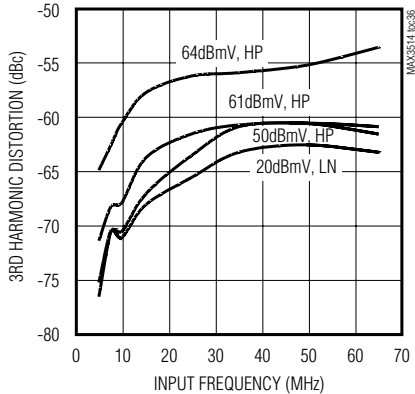

**POWER-UP/DOWN TRANSIENTS  
vs. GAIN CODE**

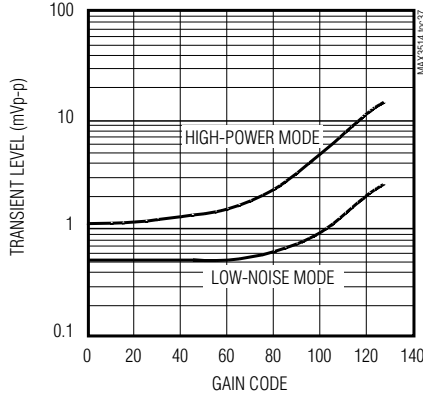

**OUTPUT RETURN LOSS vs. FREQUENCY  
(75Ω SYSTEM)**

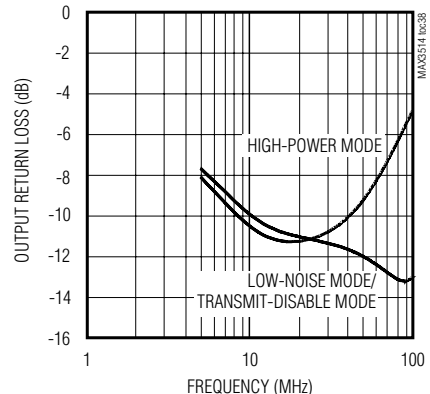

# Upstream CATV Amplifiers

## Typical Operating Characteristics (continued)

(Typical operating circuit;  $V_{CC} = +5V$ ,  $V_{IN} = +34dBmV$ ,  $TXEN = \overline{SHDN} = \text{high}$ ,  $f_{IN} = 20MHz$ ,  $Z_{LOAD} = 75\Omega$ ,  $T_A = +25^\circ C$ , unless otherwise noted.)

### MAX3516 (continued)

**OUTPUT IMPEDANCE, 5MHz–65MHz  
(75Ω SYSTEM)**

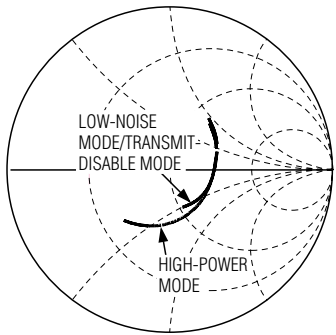

**OUTPUT SPECTRUM**

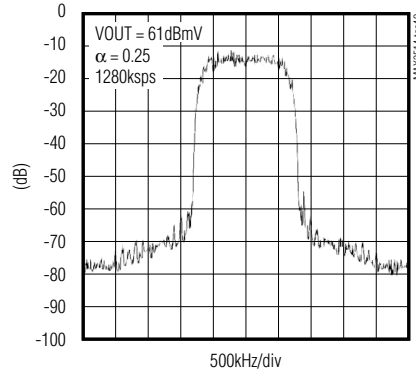

**OUTPUT SPECTRUM**

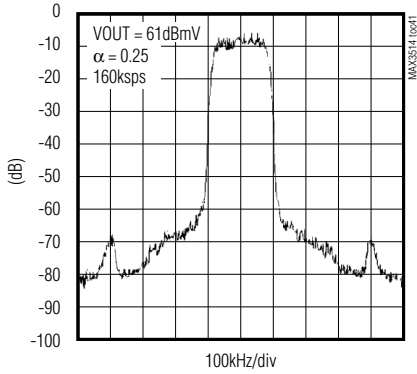

**OUTPUT SPECTRUM**

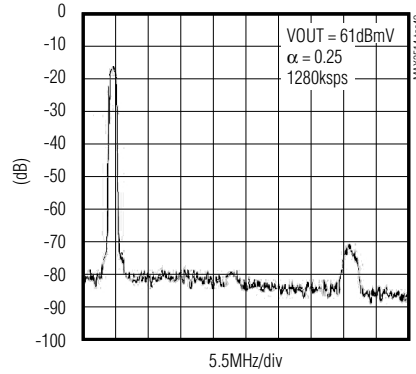

# Upstream CATV Amplifiers

## Pin Description

MAX3514/MAX3516/MAX3517

PIN	NAME	FUNCTION
1, 3, 7, 11	GND	Ground
2	VCC	Programmable-Gain Amplifier (PGA) +5V Supply. Bypass to pin 4 with a decoupling capacitor as close to the part as possible.
4	GND	PGA RF Ground. As with all ground connections, maintain the shortest possible (low-inductance) length to the ground plane.
5	IN+	Positive PGA Input. Along with IN-, this port forms a high-impedance differential input to the PGA. Driving this port differentially increases the rejection of second-order distortion at low output levels.
6	IN-	Negative PGA Input. When not used, this port must be AC-coupled to ground. See IN+.
8	$\overline{CS}$	Serial-Interface Enable. TTL-compatible input. See <i>Serial Interface</i> section.
9	SDA	Serial-Interface Data. TTL-compatible input. See <i>Serial Interface</i> section.
10	SCLK	Serial-Interface Clock. TTL-compatible input. See <i>Serial Interface</i> section.
12	$\overline{SHDN}$	Shutdown. When $\overline{SHDN}$ is set low, all functions (including the serial interface) are disabled.
13, 17	N.C.	No Connection
14	CEXT	RF Output Bypass. Bypass to ground with a 0.1 $\mu$ F capacitor. (N.C. for MAX3517.)
15	OUT-	Negative Output. Along with OUT+, this port forms a 300 $\Omega$ impedance output. This port is matched to a 75 $\Omega$ load using a 2:1 (voltage ratio) transformer.
16	OUT+	Positive Output. See OUT-.
18	TXEN	Transmit Enable. Drive TXEN high to place the device in transmit-enable mode.
19	VCC	Output Amplifier Bias, +5V Supply. Bypass to pin 20 with a decoupling capacitor as close to the part as possible.
20	GND	Output Amplifier Bias Ground. As with all ground connections, maintain the shortest possible (low-inductance) length to the ground plane.
Exposed Paddle	GND	Ground (MAX3516 only)

# Upstream CATV Amplifiers

## Functional Diagram

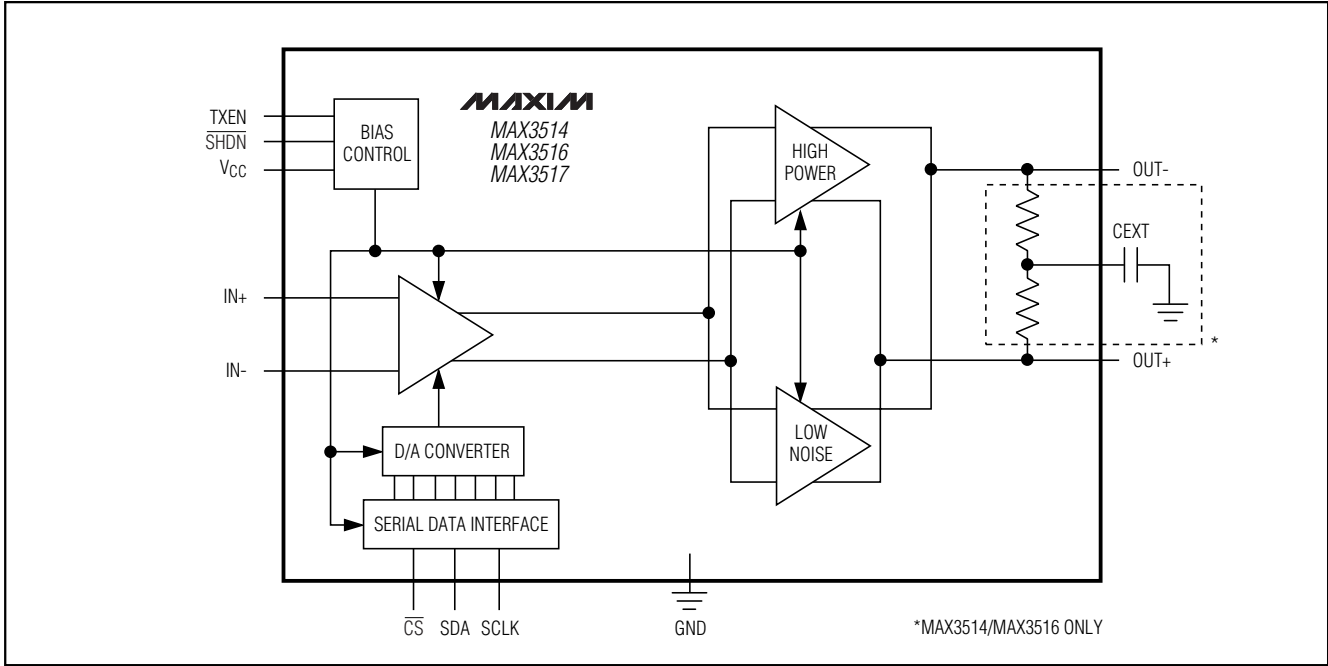

### Detailed Description

#### Programmable-Gain Amplifier

The PGA consists of the variable-gain amplifier (VGA) and the digital-to-analog converter (DAC), which provide better than 56dB of output level control in 0.5dB steps. The PGA is implemented as a programmable Gilbert-cell attenuator. The gain of the PGA is determined by a 7-bit word (D6–D0) programmed through the serial data interface (Tables 1 and 2).

Specified performance is achieved when the input is driven differentially. The device may be driven single ended. To drive the device in this manner, one of the input pins must be capacitively coupled to ground. Use a capacitor value large enough to allow for a low-impedance path to ground at the lowest frequency of operation. For operation down to 5MHz, a 0.001μF capacitor is suggested.

#### Output Amplifiers

The output amplifiers are Class A differential amplifiers capable of driving +61dBmV (QPSK, MAX3514) differentially. This architecture provides superior even-order distortion performance but requires that a transformer be used to convert to a single-ended output. In transmit-disable mode, the output amplifiers are powered

down. A resistor is across the output so that the output impedance remains matched when the amplifier is in transmit-disable mode. Disabling the output devices also results in low output noise.

#### MAX3514/MAX3516

To match the output impedance to a 75Ω load, the transformer must have a turns ratio (voltage ratio) of 2:1 (4:1 impedance ratio). The differential amplifier is biased directly from the +5V supply using the center tap of the output transformer. This provides a significant benefit when switching between transmit mode and transmit-disable mode. Stored energy due to bias currents will cancel within the transformer and prevent switching transients from reaching the load.

#### MAX3517

The MAX3517 uses external matching resistors to allow matching to various load impedances through suitable values of matching resistors and transformer turns ratios.

#### Serial Interface

The serial interface has an active-low enable ( $\overline{CS}$ ) to bracket the data, with data clocked in MSB first on the rising edge of SCLK. Data is stored in the storage latch on the rising edge of  $\overline{CS}$ . The serial interface controls



# Upstream CATV Amplifiers

the state of the PGA and the output amplifiers. Tables 1 and 2 show the register format. Serial-interface timing is shown in Figure 1.

## Applications Information

### High-Power and Low-Noise Modes

The MAX3514/MAX3516/MAX3517 have two transmit modes, high power (HP) and low noise (LN). Each of these modes is actuated by the high-order bit D7 of the 8-bit programming word. When D7 is a logic 1, HP mode is enabled. When D7 is a logic 0, LN mode is enabled.

Each of these modes is characterized by the activation of a distinct output stage. In HP mode, the output stage exhibits 15dB higher gain than LN mode. The lower gain of the LN output stage allows for significantly lower

output noise and lower transmit/transmit-disable transients.

The full range of gain codes (D6–D0) may be used in either mode. For DOCSIS applications, HP mode is recommended for output levels at or above +42dBmV (MAX3514, D7 = 1, gain code = 87), LN mode when the output level is below +42dBmV (MAX3514, D7 = 0, gain code = 115).

### Shutdown Mode

In normal operation, the shutdown pin (SHDN) is held high. When SHDN is taken low, all circuits within the IC are disabled. Only leakage currents flow in this state. Data stored within the serial-data interface latches will

**Table 1. Serial-Interface Control Word**

BIT	MNEMONIC	DESCRIPTION
MSB 7	D7	High-power/low-noise mode select
6	D6	Gain code, bit 6
5	D5	Gain code, bit 5
4	D4	Gain code, bit 4
3	D3	Gain code, bit 3
2	D2	Gain code, bit 2
1	D1	Gain code, bit 1
LSB 0	D0	Gain code, bit 0

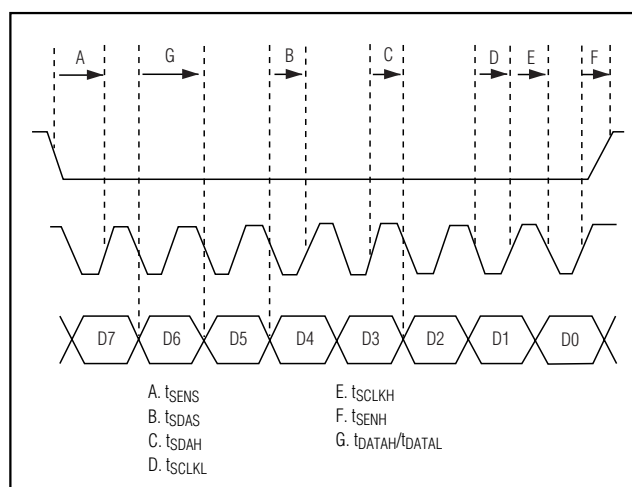

Figure 1. Serial-Interface Timing Diagram

**Table 2. Chip State Control Bits**

SHDN	TXEN	D7	D6	D5	D4	D3	D2	D1	D0	GAIN CODE (DECIMAL)	GAIN* (DB)	STATES
0	X	X	X	X	X	X	X	X	X			Shutdown Mode
1	0	X	X	X	X	X	X	X	X			Transmit-Disable Mode
1	1	1	X	X	X	X	X	X	X			Transmit-Enable Mode, High Power
1	1	0	X	X	X	X	X	X	X			Transmit-Enable Mode, Low Noise
1	1	0	0	1	1	0	0	0	0	48	-26	
1	1	0	1	0	1	0	0	0	0	80	-10	
1	1	0	1	1	1	0	0	1	1	115	8	
1	1	1	1	0	1	0	1	1	1	87	9	
1	1	1	1	1	0	1	1	1	0	110	20	
1	1	1	1	1	1	1	1	0	1	125	28	

\*Typical Gain at +25°C, VCC = 5.0V

# Upstream CATV Amplifiers

be lost upon entering this mode. Current consumption is reduced to 10 $\mu$ A (typ) in shutdown mode.

## Output Match

### MAX3514/MAX3516

When used in conjunction with a 2:1 voltage-ratio transformer, the MAX3514/MAX3516 are internally resistively matched to 75 $\Omega$ . This internal resistor is across the OUT+ and OUT- terminals.

To improve the match at the high end of the frequency range (65MHz), a reactive match may be employed as part of the ensuing diplex filter. A series inductor (typ 180nH) followed by a shunt capacitor (typ 33 $\mu$ F) can be placed directly after the output transformer. This match will also improve the gain flatness substantially.

As mentioned above, the matching components may be incorporated into the diplex filter design. Optimize the input impedance of the diplex filter to be 35 + j35 (typ) at 65MHz when using the specified output transformer.

### MAX3517

The MAX3517 does not have an internal matching resistor. This allows the device performance to be optimized for various load impedances.

When 300 $\Omega$  resistors are placed across the output terminals of the device, performance identical to the MAX3514 will result. If an impedance higher than 300 $\Omega$  is used, additional gain will result.

Note also that a 2:1 voltage-ratio output transformer is not needed.

When operating the device with arbitrary output resistance and XFMR turns ratio, take care not to exceed the allowable power dissipation (see *Absolute Maximum Ratings*).

## Transformer

To match the output of the MAX3514/MAX3516 to a 75 $\Omega$  load, a 2:1 voltage-ratio transformer is required. This transformer must have adequate bandwidth to cover the intended application. Note that most RF transformers specify bandwidth with a 50 $\Omega$  source on the primary and a matching resistance on the secondary winding. Operating in a 75 $\Omega$  system will tend to shift the low-frequency edge of the transformer bandwidth specification up by a factor of 1.5 due to primary inductance. Keep this in mind when specifying a transformer.

Bias to the output stage is provided through the center tap on the transformer primary. This greatly diminishes the on/off transients present at the output when switching between transmit and transmit-disable modes. Commercially available transformers typically have

adequate balance between half-windings to achieve substantial transient cancellation.

Finally, keep in mind that transformer core inductance varies proportionally with temperature. If the application requires low temperature extremes (less than 0 $^{\circ}$ C), adequate primary inductance must be present to sustain low-frequency output capability as temperatures drop. In general, this will not be a problem as modern RF transformers have adequate bandwidth.

## Input Circuit

To achieve rated performance, the inputs of the MAX3514/MAX3516/MAX3517 must be driven differentially with an appropriate input level. The differential input impedance is approximately 1.5k $\Omega$ . Most applications will require a differential low-pass filter preceding the device. The filter design will dictate a terminating impedance of a specified value. Place this load impedance across the AC-coupled input pins (see *Typical Operating Circuit*).

The MAX3514/MAX3517 have sufficient gain to produce an output level of +61dBmV (QPSK through a 2:1 transformer) when driven with a +34dBmV input signal. The MAX3516 provides an additional 3dB of gain and output level. When a lower input level is present, the maximum output level will be reduced proportionally and output linearity will increase. If an input level greater than +34dBmV is used, the 3rd-order distortion performance will degrade slightly.

If single-ended sources drive the MAX3514/MAX3516/MAX3517, one of the input terminals must be capacitively coupled to ground (IN+ or IN-). The value of this capacitor must be large enough to look like a short circuit at the lowest frequency of interest. For operation at 5MHz with a 75 $\Omega$  source impedance, a value of 0.001 $\mu$ F will suffice.

## Layout Issues

A well-designed PC board is an essential part of an RF circuit. For best performance, pay attention to power-supply layout issues, as well the output circuit layout.

## Output Circuit Layout

The differential implementation of the MAX3514/MAX3516/MAX3517s' output has the benefit of significantly reducing even-order distortion, the most significant of which is 2nd-harmonic distortion. The degree of distortion cancellation depends on the amplitude and phase balance of the overall circuit. It is important to keep the trace lengths from the output pins equal.

# Upstream CATV Amplifiers

## Power-Supply Layout

For minimal coupling between different sections of the IC, the ideal power-supply layout is a star configuration. This configuration has a large-value decoupling capacitor at the central power-supply node. The power-supply traces branch out from this node, each going to a separate power-supply node in the circuit. At the end of each of these traces is a decoupling capacitor that provides a very low impedance at the frequency of interest. This arrangement provides local power-supply decoupling at each power-supply pin.

The power-supply traces must be made as thick as practical.

Ground inductance degrades distortion performance. Therefore, ground plane connections to pin 4 and pin 20 should be made with multiple vias if necessary.

## Exposed Paddle Thermal Considerations

The exposed paddle (EP) of the MAX3516's 20-pin TSSOP-EP package provides a low thermal-resistance path to the die. It is important that the PC board on which the MAX3516 is mounted, be designed to conduct heat from this contact. In addition, the EP should be provided with a low inductance path to electrical ground.

It is recommended that the EP be soldered to a ground plane on the PC board, either directly or through an array of plated via holes.

## Typical Operating Circuit

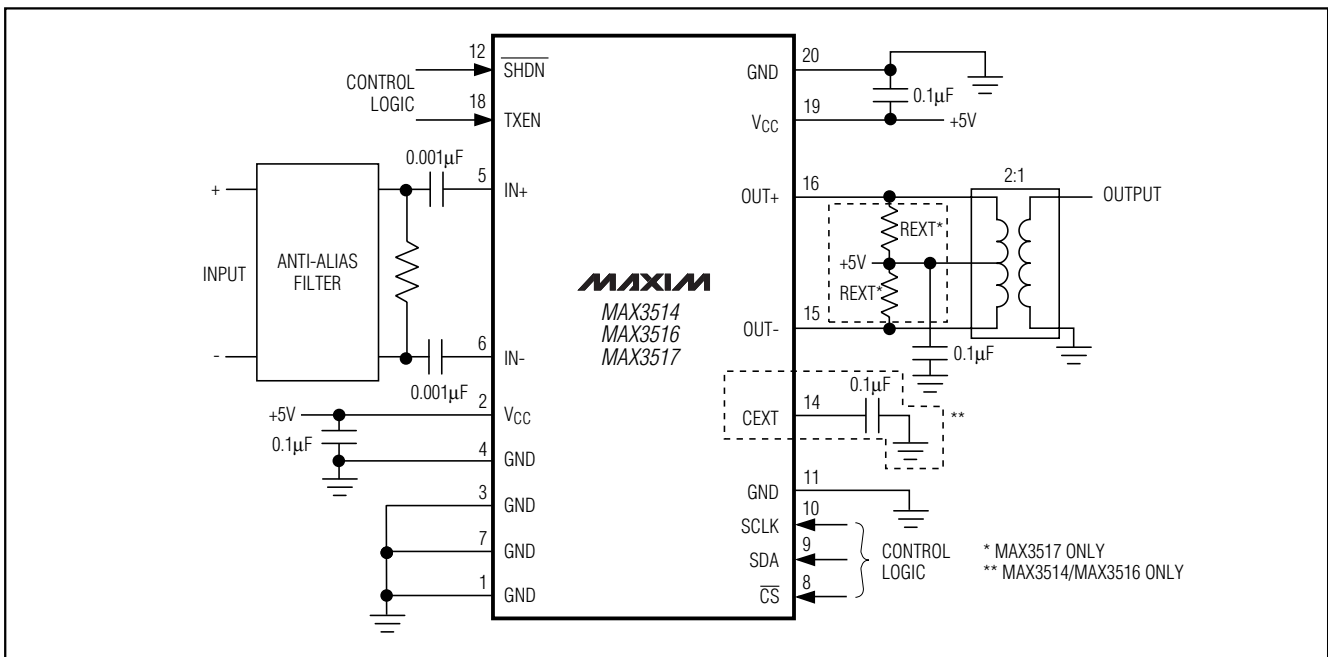

## Chip Information

TRANSISTOR COUNT: 1006

# Upstream CATV Amplifiers

## Package Information

**COMMON DIMENSIONS**

SYMBOL	MILLIMETERS		INCHES	
	MIN.	MAX.	MIN.	MAX.
A	—	1.10	—	.043
A <sub>1</sub>	0.05	0.15	.002	.006
A <sub>2</sub>	0.85	0.95	.033	.037
b	0.19	0.30	.007	.012
b <sub>1</sub>	0.19	0.25	.007	.010
c	0.090	0.20	.0035	.008
c <sub>1</sub>	0.090	0.135	.0035	.0053
D	SEE VARIATIONS		SEE VARIATIONS	
E	4.30	4.50	.169	.177
e	0.65 BSC		.026 BSC	
H	6.25	6.50	.246	.256
L	0.50	0.70	.020	.028
N	SEE VARIATIONS		SEE VARIATIONS	
Y	2.85	3.15	.112	.124
α	0°	8°	0°	8°

JEDEC	N	VARIATIONS			
		MILLIMETERS		INCHES	
		MIN.	MAX.	MIN.	MAX.
AB	14	4.90	5.10	.193	.201
AC	16	4.90	5.10	.193	.201
AC-EP	16	4.90	5.10	.193	.201
	X	2.85	3.15	.112	.124
AD	20	6.40	6.60	.252	.260
AD-EP	20	6.40	6.60	.252	.260
	X	4.00	4.34	.157	.171
AE	24	7.70	7.90	.303	.311
AF	28	9.60	9.80	.378	.386
AF-EP	D	9.60	9.80	.378	.386
	X	5.35	5.65	.211	.222

**NOTES:**

- DIMENSIONS D AND E DO NOT INCLUDE FLASH.
- MOLD FLASH OR PROTRUSIONS NOT TO EXCEED .15 mm PER SIDE.
- CONTROLLING DIMENSION: MILLIMETER.
- MEETS JEDEC OUTLINE MD-153 VARIATIONS AB, AC, AD, AE, AF.
- DIMENSIONS X AND Y APPLY TO EXPOSED PAD (EP) VERSIONS ONLY.
- EXPOSED PAD FLUSH WITH BOTTOM OF PACKAGE WITHIN .002".

TSSOP-EP

# Upstream CATV Amplifiers

## Package Information (continued)

MAX3514/MAX3516/MAX3517

QSOP-EFS

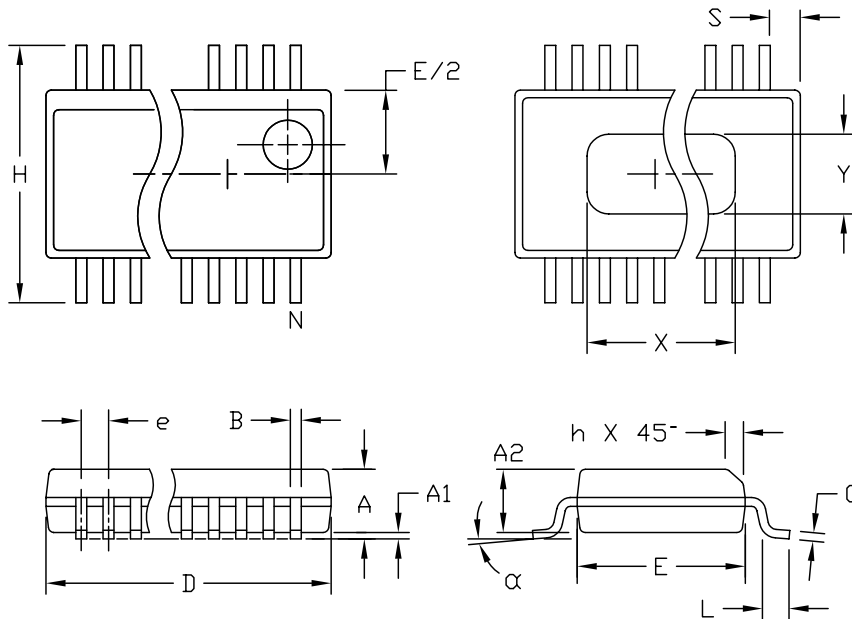

DIM	INCHES		MILLIMETERS	
	MIN	MAX	MIN	MAX
A	.061	.068	1.55	1.73
A1	.004	.0098	0.102	0.249
A2	.055	.061	1.40	1.55
B	.008	.012	0.20	0.31
C	.0075	.0098	0.191	0.249
D	SEE VARIATIONS			
E	.150	.157	3.81	3.99
e	.025 BSC		0.635 BSC	
H	.230	.244	5.84	6.20
h	.010	.016	0.25	0.41
L	.016	.035	0.41	0.89
N	SEE VARIATIONS			
X	SEE VARIATIONS			
Y	.071	.087	1.803	2.209
α	0°	8°	0°	8°

### VARIATIONS:

DIM	INCHES		MILLIMETERS		N
	MIN.	MAX.	MIN.	MAX.	
D	.189	.196	4.80	4.98	16 AA
S	.0020	.0070	0.05	0.18	
X	.107	.123	2.72	3.12	
D	.337	.344	8.56	8.74	20 AB
S	.0500	.0550	1.270	1.397	
D	.337	.344	8.56	8.74	24 AC
S	.0250	.0300	0.635	0.762	
D	.386	.393	9.80	9.98	28 AD
S	.0250	.0300	0.635	0.762	
X	.271	.287	6.88	7.29	

### NOTES:

1. D & E DO NOT INCLUDE MOLD FLASH OR PROTRUSIONS.
2. MOLD FLASH OR PROTRUSIONS NOT TO EXCEED .006" PER SIDE.
3. HEAT SLUG DIMENSIONS X AND Y APPLY ONLY TO 16 AND 28 LEAD POWER-QSOP PACKAGES.
4. CONTROLLING DIMENSIONS: INCHES.
5. MEETS JEDEC MO137.

**MAXIM**

PROPRIETARY INFORMATION

TITLE:

PACKAGE OUTLINE, QSOP, .150", .025" LEAD PITCH

APPROVAL	DOCUMENT CONTROL NO.	REV	
	21-0055	C	1/1

Maxim cannot assume responsibility for use of any circuitry other than circuitry entirely embodied in a Maxim product. No circuit patent licenses are implied. Maxim reserves the right to change the circuitry and specifications without notice at any time.

Maxim Integrated Products, 120 San Gabriel Drive, Sunnyvale, CA 94086 408-737-7600 \_\_\_\_\_ 21