

<b>SANYO</b>	No.2290C	<b>LC7582,7582E,7582W</b>
		LCD Driver

**Overview**

The LC7582,7582E,7582W is a general-purpose LCD driver designed for use in electronic tuning frequency display or microcomputer-controlled system applications.

**Features**

- . 53 segments (max.) output (Static display)
- . Drive system: 1/1duty (53 segments), 1/2duty (104 segments)
- . Data input: 3 serial input pins
- . 2 pins for 5-level AD converter (Level meter use, etc.)
- . 2 display (DSP) pins for direct display
- . INH pin for blanking out display

**Absolute Maximum Ratings** at Ta=25°C, V<sub>SS</sub>=0V

				unit
Maximum Supply Voltage	V <sub>DDmax</sub>	V <sub>DD</sub>	-0.3 to +7.0	V
Input Voltage	V <sub>LCD</sub>	V <sub>LCD</sub>	-0.3 to V <sub>DD</sub> +0.3	V
	V <sub>IN</sub> (1)	CE, CLK, DATA, INH	-0.3 to +7.0	V
Output Voltage	V <sub>IN</sub> (2)	S44 to S47	Output OFF (Used as AD1, AD2, DSP1, DSP2)	-0.3 to V <sub>DD</sub> +0.3
	V <sub>IN</sub> (3)	OSC	Output OFF	-0.3 to V <sub>DD</sub> +0.3
Output Current	I <sub>OUT</sub> (1)	S1 to S53	Output OFF	100 uA
Allowable Power Dissipation	I <sub>OUT</sub> (2)	COM1,2	Output OFF	1.0 mA
	P <sub>dmax</sub>	Ta=85°C		100 mW
Operating Temperature	Topg			-30 to +85 °C
Storage Temperature	Tstg			-40 to +125 °C

Case Outline 3057 [LC7582]  
(unit: mm)

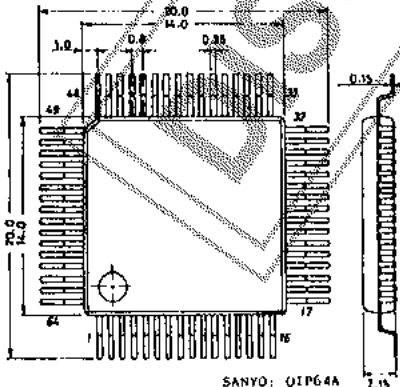

Case Outline 3159 [LC7582E]  
(unit: mm)

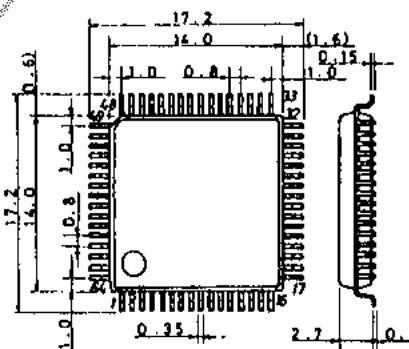

Case Outline 3190 [LC7582W]  
(unit: mm)

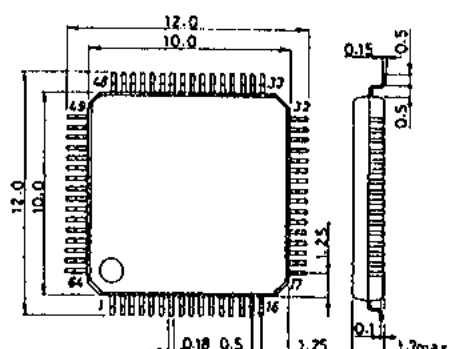

Specifications and information herein are subject to change without notice.

**SANYO Electric Co., Ltd. Semiconductor Business Headquarters**  
TOKYO OFFICE Tokyo Bldg., 1-10, 1 Chome, Ueno, Taito-ku, TOKYO, 110 JAPAN

Allowable Operating Conditions at Ta=-30 to +85°C, V<sub>SS</sub>=0V

		Pin	min	typ	max	unit
Supply Voltage	V <sub>DD</sub>	V <sub>DD</sub>	3.0		6.5	V
	V <sub>LCD</sub>	V <sub>LCD</sub>	3.0		V <sub>DD</sub>	V
Input "H"-Level Voltage	V <sub>IH</sub> (1)	INH	0.7V <sub>DD</sub>		6.5	V
Input "L"-Level Voltage	V <sub>IL</sub> (1)	"	0		0.3V <sub>DD</sub>	V
Input "H"-Level Voltage	V <sub>IH</sub> (2)	S44,S46	0.7V <sub>DD</sub>		V <sub>DD</sub>	V
			[Output OFF(DSP1, DSP2-used mode)]			
Input "L"-Level Voltage	V <sub>IL</sub> (2)	"	0		0.3V <sub>DD</sub>	V
Input "H"-Level Voltage	V <sub>IH</sub> (3)	CE,CLK,DATA	0.8V <sub>DD</sub>		6.5	V
Input "L"-Level Voltage	V <sub>IL</sub> (3)	"	0		0.2V <sub>DD</sub>	V
Recommended External Resistance	R	OSC		51		kohm
Recommended External Capacitance	C	OSC		680		pF
OSC Guaranteed Range	f <sub>OSC</sub>	OSC	25	50	100	kHz
"L"-Level Clock Pulse Width	t <sub>∅L</sub>	CLK	0.25			usec
"H"-Level Clock Pulse Width	t <sub>∅H</sub>	"	0.25			usec
Setup Time	t <sub>sup</sub>	CLK,DATA	0.25			usec
Data Hold Time	t <sub>dh</sub>	"	0.25			usec
Serial Data Pulse Width	t <sub>1</sub>	CE,DATA	1			usec
"	t <sub>2</sub>	CE,CLK	1.25			usec
"	t <sub>3</sub>				1	usec
"	t <sub>4</sub>		4			usec

Electrical Characteristics under Allowable Operating Conditions

		Pin	min	typ	max	unit
Input "H"-Level Current	I <sub>IH</sub> (1)	CE,CLK,DATA, INH			5	uA
Input "L"-Level Current	I <sub>IL</sub> (1)	"			5	uA
Input "H"-Level Current	I <sub>IH</sub> (2)	S44,S46			10	uA
Input "L"-Level Current	I <sub>IL</sub> (2)	"			10	uA
Input "H"-Level Current	I <sub>IH</sub> (3)	AD1,AD2			10	uA
Input "L"-Level Current	I <sub>IL</sub> (3)	"			10	uA
Output "H"-Level Voltage	V <sub>OH</sub> (1)	S1 to S53	I <sub>o</sub> =-10uA	V <sub>DD</sub> -1.0		V
Output "L"-Level Voltage	V <sub>OL</sub> (1)	"	I <sub>o</sub> =10uA		1.0	V
Output "H"-Level Voltage	V <sub>OH</sub> (2)	COM1,COM2	I <sub>o</sub> =-100uA	V <sub>LCD</sub> -0.6		V
Output "L"-Level Voltage	V <sub>OL</sub> (2)	"	I <sub>o</sub> =100uA		0.6	V

Continued on next page.

# LC7582,7582E,7582W

Continued from preceding page.

	Pin	min	typ	max	unit
Center Level Voltage	$V_{MID}$	"	$V_{LCD}=6.5V,$ $I_o=100\mu A$	2.65 3.25	3.85 V
"	$V_{MID}$	"	$V_{LCD}=3.0V,$ $I_o=100\mu A$	0.9 1.5	2.1 V
1st Step Lighting Voltage	$V_{A1}$	S45, S47		$0.07V_{DD}$ $0.1V_{DD}$ $0.13V_{DD}$	V
2nd "	$V_{A2}$	"		$0.17V_{DD}$ $0.2V_{DD}$ $0.23V_{DD}$	V
3rd "	$V_{A3}$	"		$0.27V_{DD}$ $0.3V_{DD}$ $0.33V_{DD}$	V
4th "	$V_{A4}$	"		$0.37V_{DD}$ $0.4V_{DD}$ $0.43V_{DD}$	V
5th "	$V_{A5}$	"		$0.47V_{DD}$ $0.5V_{DD}$ $0.53V_{DD}$	V
Step Voltage Diff.	$V_{step}$	"	See Fig.1	$0.09V_{DD}$ $0.1V_{DD}$ $0.11V_{DD}$	V
OSC Frequency	$f_{osc}$	osc	$R=51k\Omega, C=680pF$	40 50	60 kHz
Supply Current	$I_{DD}$				1 mA
"	$I_{LCD}$				2 mA
Hysteresis Voltage	$V_H$	$V_{LCD}$ CE, CLK, DATA	$V_{DD}=5V$	0.3	V

## Pin Assignment

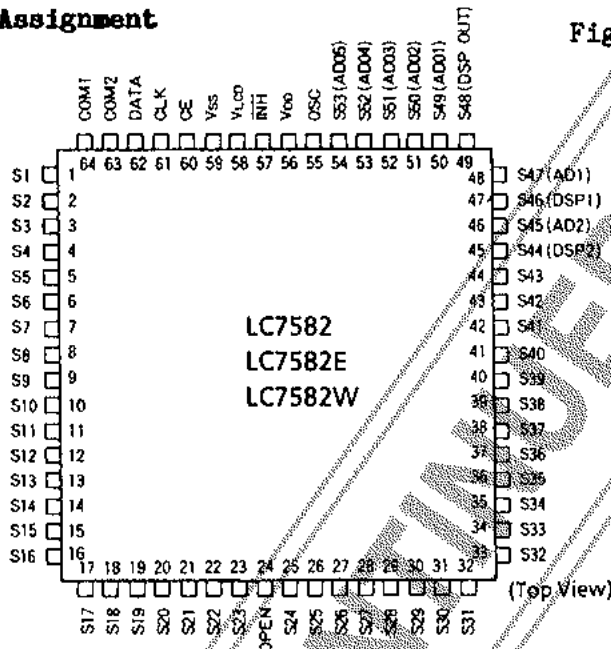
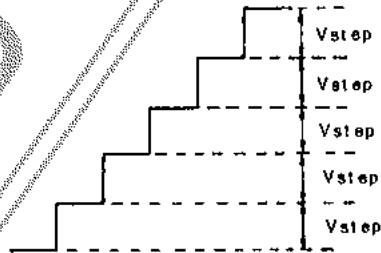
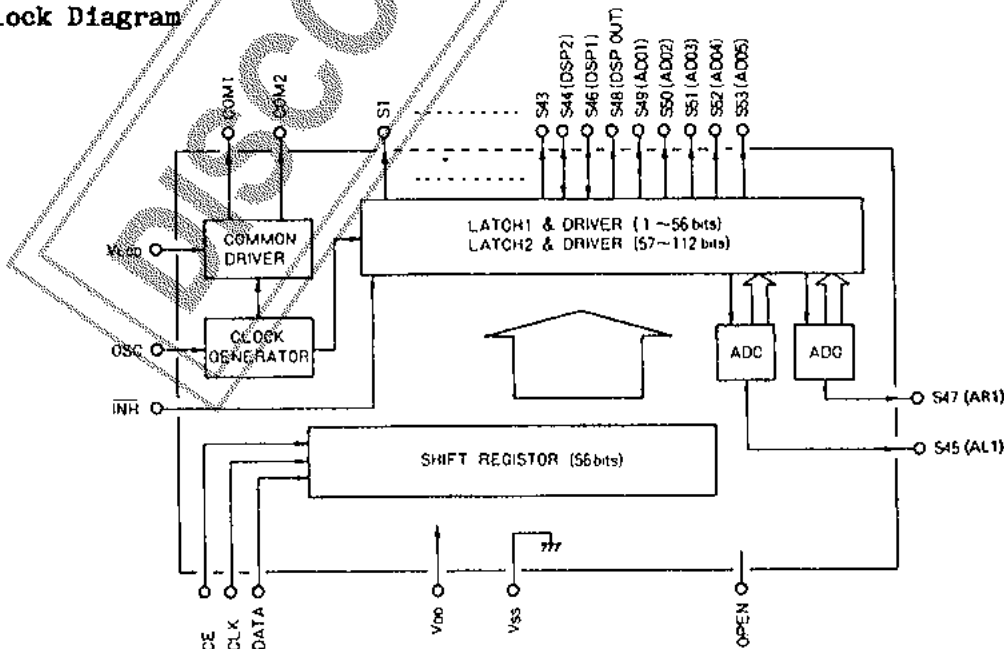

Fig.1 Step Voltage Difference Input voltage on S45(AD2), S47(AD1)



## Block Diagram



**Pin Description**

- . S1 to S43 : Segment output pin
- . S46(DSP1),S44(DSP2) : Segment output or DSP input pin
- . S47(AD1),S45(AD2) : Segment output or AD input pin
- . S48(DSPOUT) : Segment output or DSP output pin
- . S49 to S53(AD0to5) : Segment output or AD output pin
- . COM1,2 : Common output pin (COM1 only is used for 1/1duty and in this case COM2 is open.)
- . V<sub>LCD</sub> : LCD bias voltage setting pin
- . OSC : OSC pin
- . CE,CLK,DATA : Input pin for serial data transfer
- . V<sub>SS</sub>,V<sub>DD</sub> : Power supply pin
- . INH : Display blanking input pin (Available for output driver only. Therefore, serial data can be also transferred during unlighting.)
- . OPEN : No connection

**Data Transfer Mode**

- . 1/1duty

Transfer direction (56 bits)

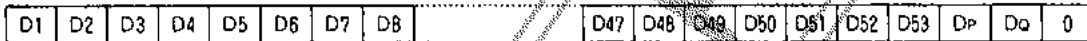

- . 1/2duty (When the number of display segments does not exceed 52, transfer data is 56 bits long. Transfer mode is the same as for 1/1 duty. Data of D54 to D106 only cannot be changed.)

Transfer direction (112 bits)



D53, D106: Dummy bit (don't care)

- D<sub>1</sub> to D<sub>53</sub> : Display data (1/1duty)                      Lighted at "1"
- D<sub>1</sub> to D<sub>106</sub> : Display data (1/2duty)                      Unlighted at "0"
- (Note) When the AD, DSP functions are selected:
- 1/1duty : D46 to D53 ----- Dummy bit (don't care)
- 1/2duty : D88 to D106 ----- Dummy bit (don't care)
- DP : Drive mode select bit
- 1/2duty at "1"
- 1/1duty at "0"
- DQ : AD, DSP function select bit
- AD, DSP function at "1"
- Segment output at "0"
- X : Don't care

(Note) When the AD, DSP functions selected are not used, fix the AD1,AD2,DSP1,DSP2 pins at V<sub>DD</sub> or V<sub>SS</sub>.

**Sample Transfers**

. 1/1 duty



. 1/2 duty and 52 segments or less

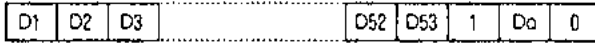

. 1/2 duty and 52 segments or more

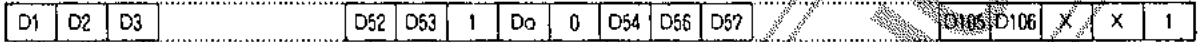

(Note) 1/2 duty and 52 segments or less do not allow transfer shown below.

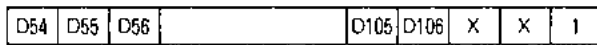

**Serial Data**

. 1/1 duty (56bits)

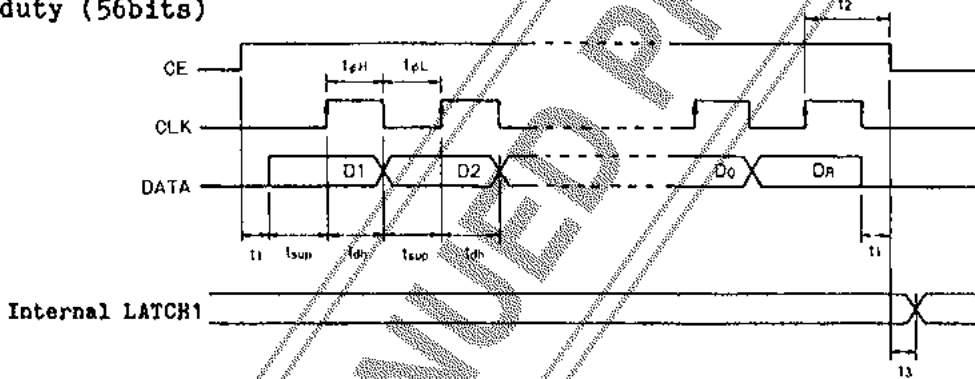

. 1/2 duty (112bits)

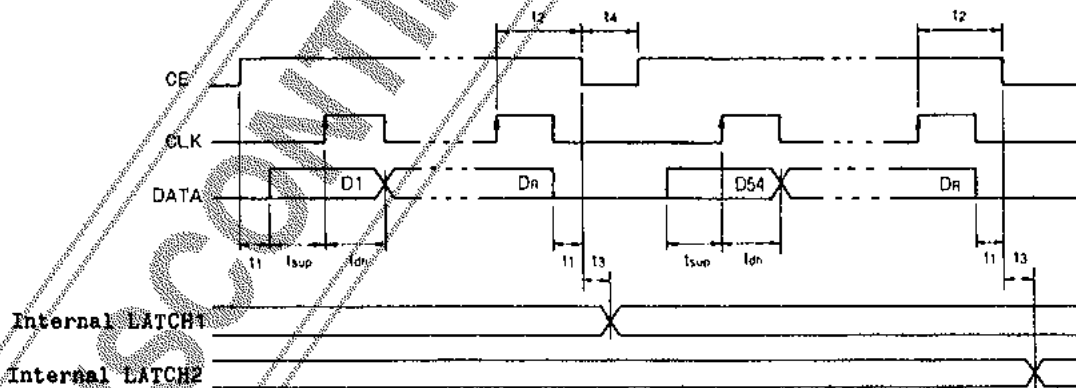

**Output Waveforms**

. 1/1 duty

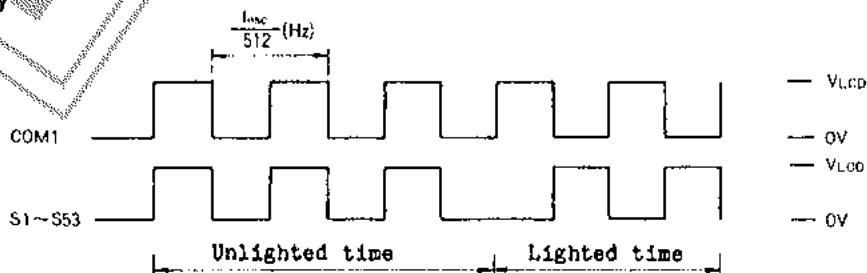

LC7582,7582E,7582W

. 1/2 duty

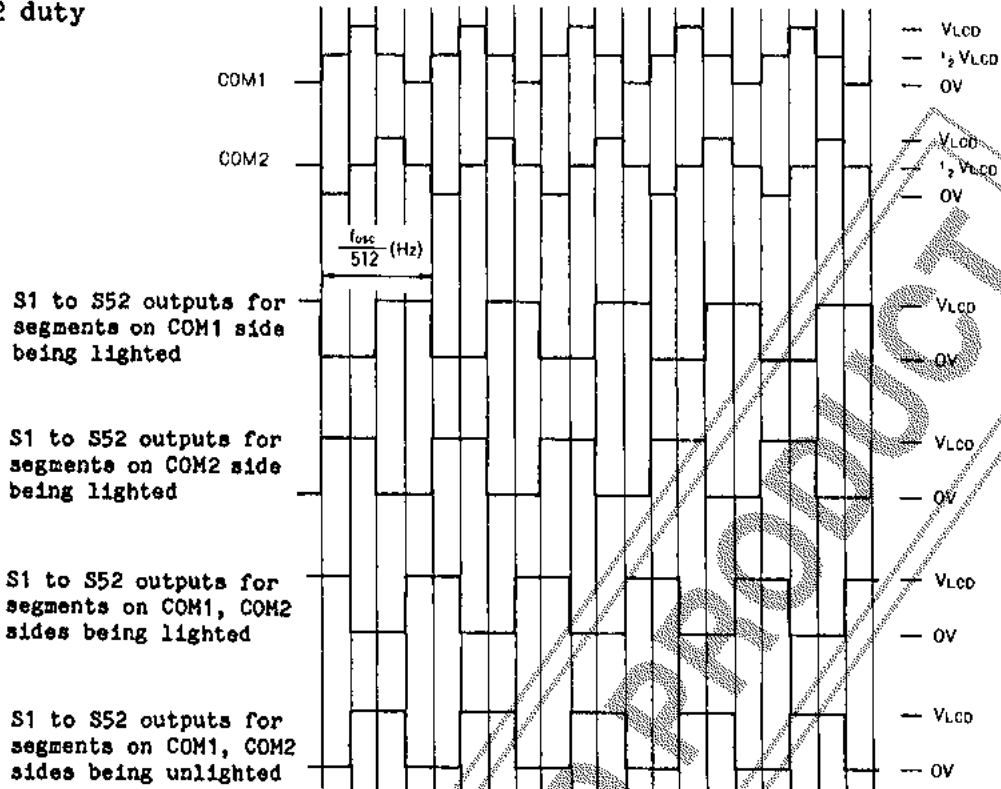

Sample Display

. Static drive (1/1duty) (AD, DSP pins are not used.)

40 segments-used application (Up to 53 segments usable)

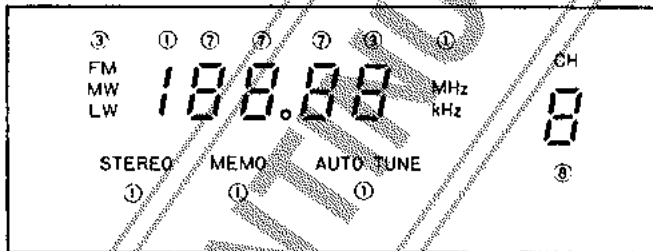

Note: ○ : Number of segments

. 1/2duty drive

71 segments-used application (Up to 104 segments usable)

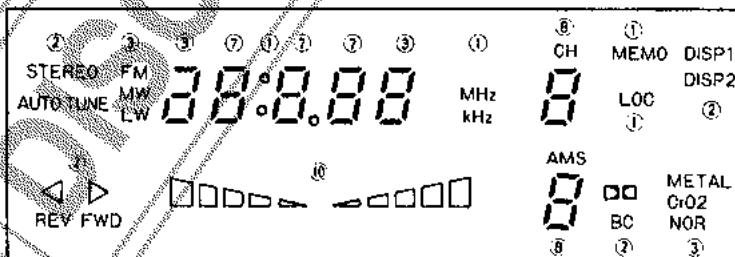

Sample Application Circuit 1

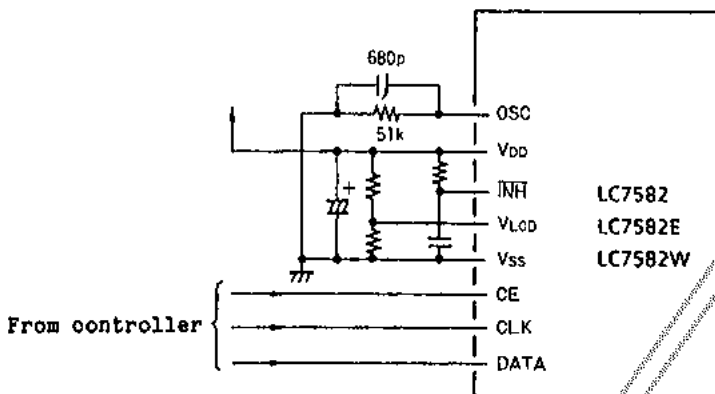

Sample Application Circuit 2

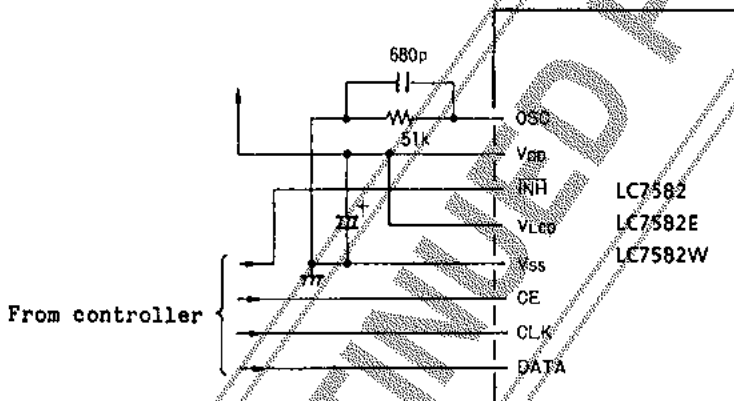

Note) The internal display data is indeterminate immediately after  $V_{DD}$  rise. If the display is kept lighted as it is, the display will have no meaning. The display is forced to be unlighted when the  $\overline{INH}$  is at "L" level. Do not release ("H") until the transfer of display data from the controller is completed.

LC7582,7582E,7582W

Correspondence between Transfer (External Input) Data and Output Pin

(Note) COM1 only is used at 1/1 duty.

Output pin	DP		0		1		COM1	COM2
	DQ	0		1				
		1/1 duty		1/2 duty				
S1	D1	D1	D1	D1	○			
			D2	D2		○		
S2	D2	D2	D3	D3	○			
			D4	D4		○		
S3	D3	D3	D5	D5	○			
			D6	D6		○		
S26	D26	D26	D51	D51	○			
			D52	D52		○		
S27	D27	D27	D54	D54	○			
			D55	D55		○		
S28	D28	D28	D56	D56	○			
			D57	D57		○		
S43	D43	D43	D86	D86	○			
			D87	D87		○		
S44	D44	D44	D88	※DSP 2	○			
			D89			○		
S45	D45	D45	D90	※ALI	○			
			D91			○		
S46	D46	※DSP 1	D92	※DSP 1	○			
			D93			○		
S47	D47	※ARI	D94	※ARI	○			
			D95			○		
S48	D48	※DISPO1	D96	※DSPO1	○			
			D97	※DSPO2		○		
S49	D49	※ARO1	D98	※ARO1	○			
			D99	※ALO1		○		
S50	D50	※ARO2	D100	※ARO2	○			
			D101	※ALO2		○		
S51	D51	※ARO3	D102	※ARO3	○			
			D103	※ALO3		○		
S52	D52	※ARO4	D104	※ARO4	○			
			D105	※ALO4		○		
S53	D53	※ARO5	Always lighting	※ARO5	○			
			Always lighting	※ALO5		○		

Note

- . DSP1 : External display input data name. The output is DSP01.
- . DSP01 : External display output data name. The input is DSP1.
- . DSP2 : External display input data name. The output is DSP02.
- . DSP02 : External display output data name. The input is DSP2.
- . ARI : AD converter input data name. The output is ARO1 to 5.
- . ARO1 to 5 : AD converter output data name. The input is ARI.
- . ALI : AD converter input data name. The output is ALO1 to 5.
- . ALO1 to 5 : AD converter output data name. The input is ALI.



**OSC Frequency**

When determining the OSC frequency, see below.

Fig. 1 OSC Frequency at OSC Pin vs. CR

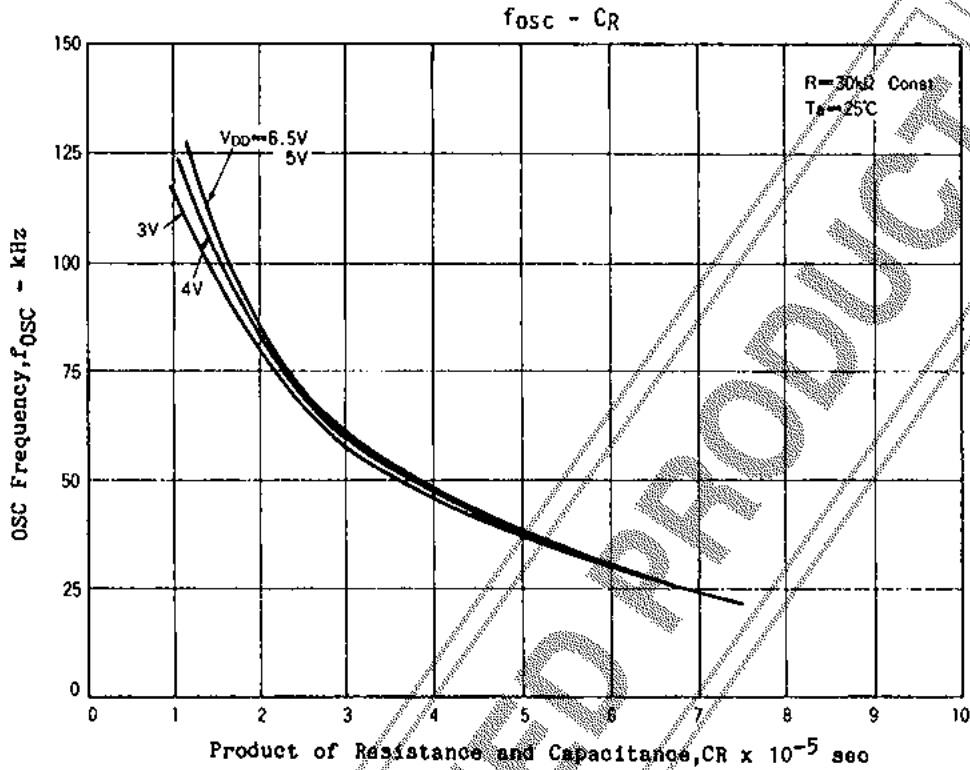
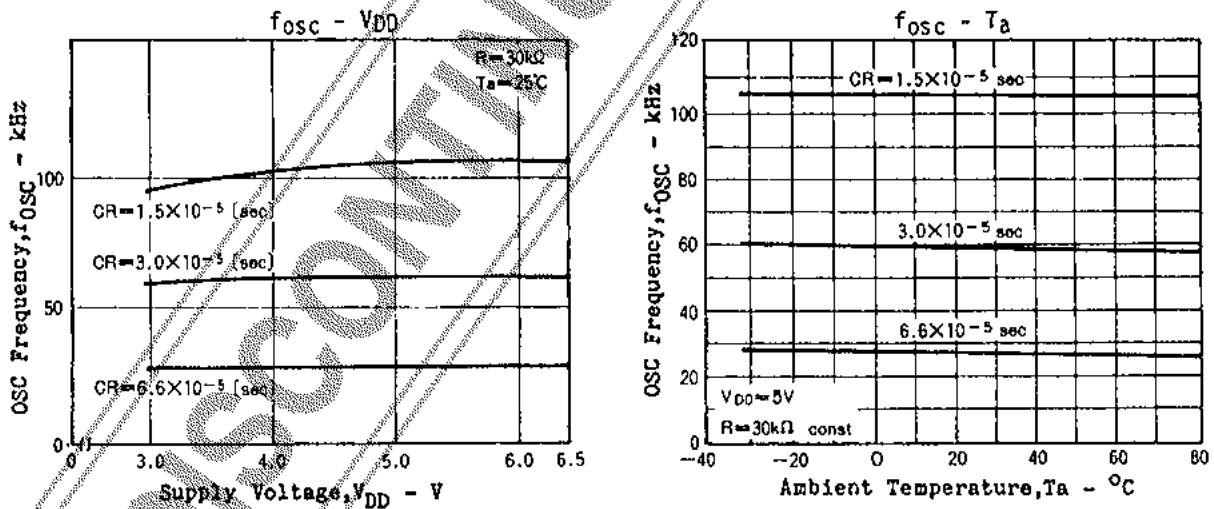

Fig. 2 OSC Frequency at OSC Pin vs.  $V_{DD}$



Recommended external resistor value  
Recommended external capacitor value

- 10kohms to 100kohms (carbon)
- 330pF to 3300pF
- 330pF to 820pF (ceramic, temperature coefficient: 0)
- 1000pF to 3300pF (polyester, temperature coefficient: plus)

Information (including circuit diagrams and circuit parameters) herein is for example only; it is not guaranteed for volume production. SANYO believes information herein is accurate and reliable, but no guarantees are made or implied regarding its use or any infringement of intellectual property rights or other rights of third parties.