

### General Description

The MIC5238 is an ultra-low voltage output, 150mA LDO regulator. Designed to operate in a single supply or dual supply mode, the MIC5238 consumes only 23 $\mu$ A of bias current, improving efficiency. When operating in the dual supply mode, the efficiency greatly improves as the higher voltage supply is only required to supply the 23 $\mu$ A bias current while the output and base drive comes off of the much lower input supply voltage.

As a  $\mu$ Cap regulator, the MIC5238 operates with a 2.2 $\mu$ F ceramic capacitor on the output, offering a smaller overall solution. It also incorporates a logic-level enable pin that allows the MIC5238 to be put into a zero off-current mode when disabled.

The MIC5238 is fully protected with current limit and thermal shutdown. It is offered in the IttyBitty™ SOT-23-5 package with an operating junction temperature range of -40°C to +125°C.

### Features

- Ultra-low input voltage range: 1.5V to 6V
- Ultra-low output voltage: 1.1V minimum output voltage
- Low dropout voltage: 310mV at 150mA
- High output accuracy:  $\pm 2.0\%$  over temperature
- $\mu$ Cap: stable with ceramic or tantalum capacitors
- Excellent line and load regulation specifications
- Zero shutdown current
- Reverse leakage protection
- Thermal shutdown and current limit protection
- IttyBitty™ SOT-23-5 package

### Applications

- PDAs and pocket PCs
- Cellular phones
- Battery powered systems
- Low power microprocessor power supplies

### Ordering Information

Part Number	Marking	Voltage*	Junction Temp. Range	Package*
MIC5238-1.1BM5	L411	1.1V	-40°C to +125°C	SOT-23-5
MIC5238-1.3BM5	L413	1.3V	-40°C to +125°C	SOT-23-5
MIC5238-1.1BD5	N411	1.1V	-40°C to +125°C	TSOT-23-5
MIC5238-1.3BD5	N413	1.3V	-40°C to +125°C	TSOT-23-5

\* For other voltages and package option contact the factory

### Typical Application

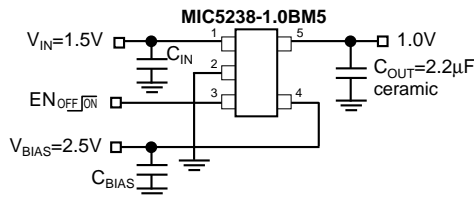

### Ultra-Low Voltage Application

## Pin Configuration

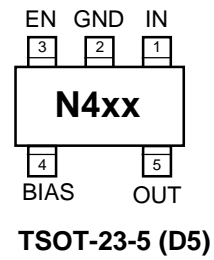
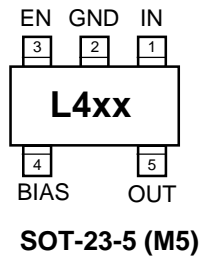

## Pin Description

SOT-23-5	Pin Name	Pin Function
1	IN	Supply Input
2	GND	Ground
3	EN	Enable (Input): Logic low = shutdown; logic high = enable. Do not leave open.
4	BIAS	BiasSupply Input
5	OUT	Regulator Output

**Absolute Maximum Ratings (Note 1)**

Input Supply Voltage .....	-0.3V to 7V
BIAS Supply Voltage .....	-0.3V to 7V
Enable Input Voltage .....	-0.3V to 7V
Power Dissipation .....	Internally Limited
Junction Temperature .....	-40°C to +125°C
Storage Temperature .....	-65°C to +150°C
ESD Rating, >1.5μA HBM, <b>Note 3</b>	

**Operating Ratings (Note 2)**

Input Supply Voltage .....	1.5V to 6V
BIAS Supply Voltage .....	2.3V to 6V
Enable Input Voltage .....	0V to 6V
Junction Temperature (T <sub>J</sub> ) .....	-40°C to +125°C
Package Thermal Resistance SOT-23-5 (θ <sub>JA</sub> ) .....	235°C/W

**Electrical Characteristics (Note 4)**

T<sub>A</sub> = 25°C with V<sub>IN</sub> = V<sub>OUT</sub> + 1V; V<sub>BIAS</sub> = 3.3V; I<sub>OUT</sub> = 100μA; V<sub>EN</sub> = 2V, **Bold** values indicate -40°C < T<sub>J</sub> < +125°C; unless otherwise specified.

Parameter	Condition	Min.	Typ.	Max.	Units
Output Voltage Accuracy	Variation from nominal V <sub>OUT</sub>	-1.5 <b>-2</b>		+1.5 <b>+2</b>	% %
Line Regulation	V <sub>BIAS</sub> = 2.3V to 6V, <b>Note 5</b>		0.25	0.5	%
Input Line Regulation	V <sub>IN</sub> = (V <sub>OUT</sub> + 1V) to 6V		0.04		%
Load Regulation	Load = 100μA to 150mA		0.7	1	%
Dropout Voltage	I <sub>OUT</sub> = 100μA		50		mV
	I <sub>OUT</sub> = 50mA		230	300	mV
	I <sub>OUT</sub> = 100mA		270	<b>400</b>	mV
	I <sub>OUT</sub> = 150mA		310	450 <b>500</b>	mV mV
BIAS Current, <b>Note 6</b>	I <sub>OUT</sub> = 100μA		23		μA
Input Current, <b>Pin 1</b>	I <sub>OUT</sub> = 100μA		7	<b>20</b>	μA
	I <sub>OUT</sub> = 50mA, <b>Note 7</b>		0.35		mA
	I <sub>OUT</sub> = 100mA		1		mA
	I <sub>OUT</sub> = 150mA		2	<b>2.5</b>	mA
Ground Current in Shutdown	V <sub>EN</sub> ≤ 0.2V; V <sub>IN</sub> = 6V; V <sub>BIAS</sub> = 6V		1.5	5	μA
	V <sub>EN</sub> = 0V; V <sub>IN</sub> = 6V; V <sub>BIAS</sub> = 6V		0.5		μA
Short Circuit Current	V <sub>OUT</sub> = 0V		350	<b>500</b>	mA
Reverse Leakage	V <sub>IN</sub> = 0V; V <sub>EN</sub> = 0V; V <sub>OUT</sub> = nom V <sub>OUT</sub>		5		μA

**Enable Input**

Input Low Voltage	Regulator OFF			<b>0.2</b>	V
Input High Voltage	Regulator ON	<b>2.0</b>			V
Enable Input Current	V <sub>EN</sub> = 0.2V; Regulator OFF	-1.0	0.01	1.0	μA
	V <sub>EN</sub> = 2.0V; Regulator ON		0.1	1.0	μA

**Note 1.** Exceeding the absolute maximum rating may damage the device.

**Note 2.** The device is not guaranteed to function outside its operating rating.

**Note 3.** Devices are ESD sensitive. Handling precautions recommended. Human body model, 1.5k in series with 100pF.

**Note 4.** Specification for packaged product only.

**Note 5.** Line regulation measures a change in output voltage due to a change in the bias voltage.

**Note 6.** Current measured from bias input to ground.

**Note 7.** Current differential between output current and main input current at rated load current.

# Typical Characteristics

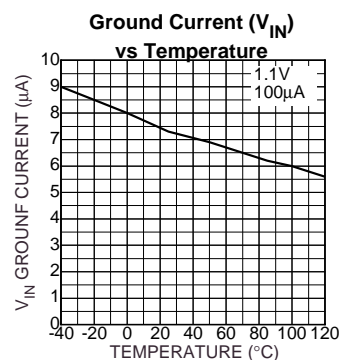
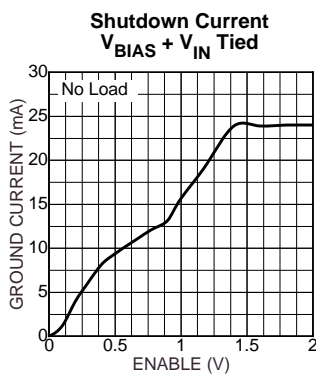
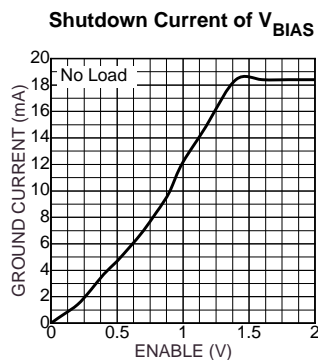
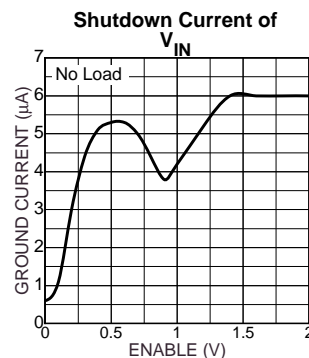
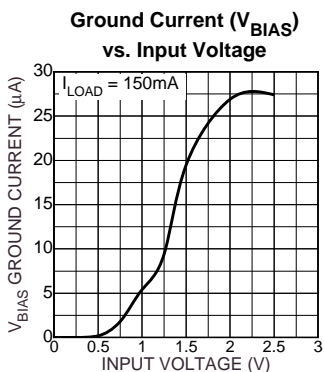
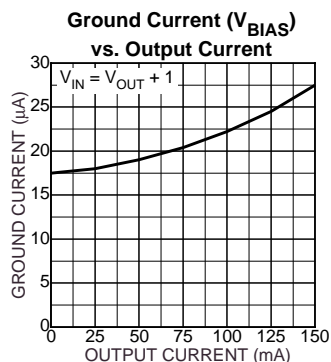
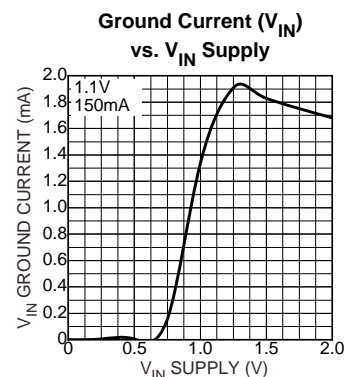
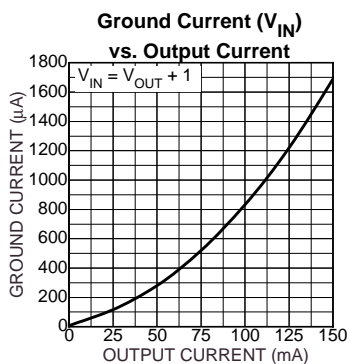
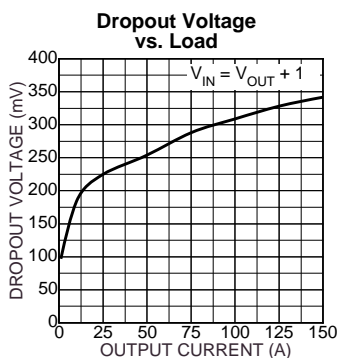
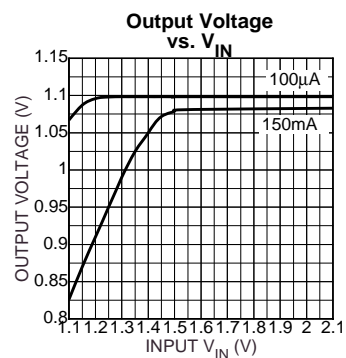
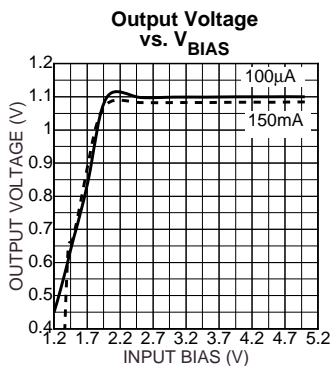
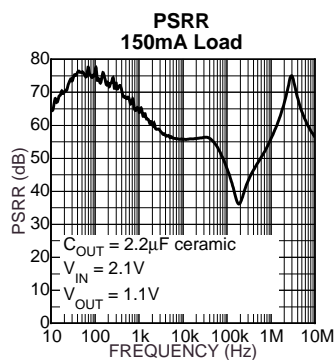

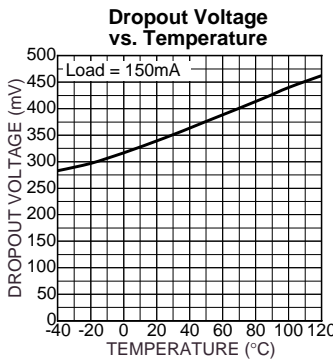
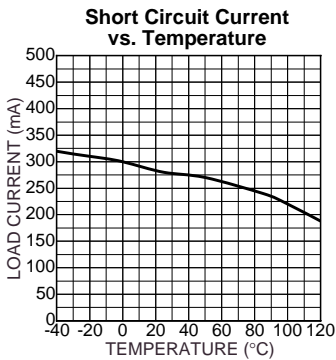
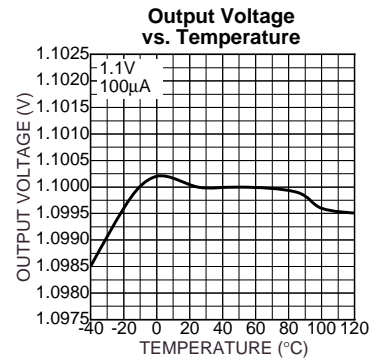
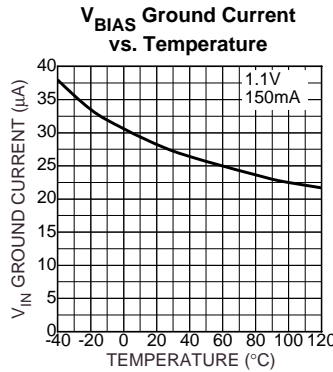
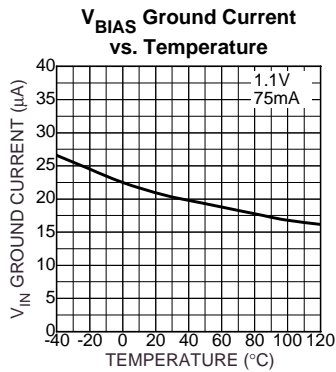
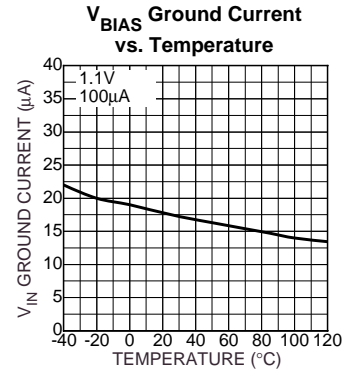
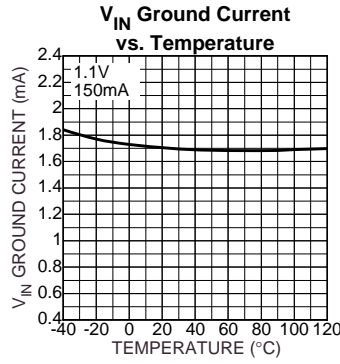
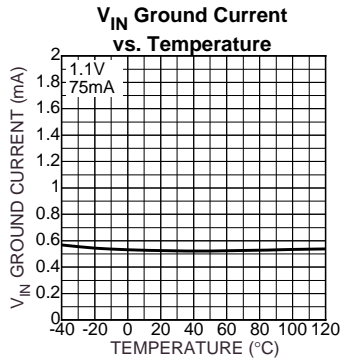

Line Transient Response

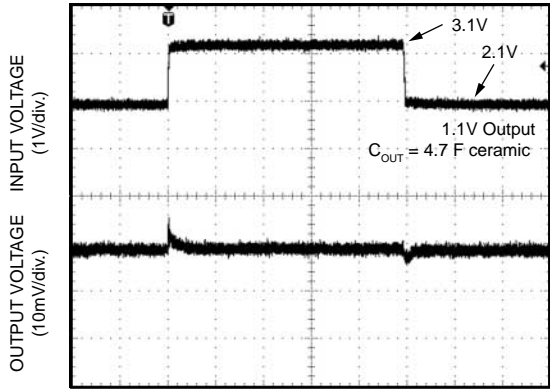

TIME (200 s/div.)

Load Transient Response

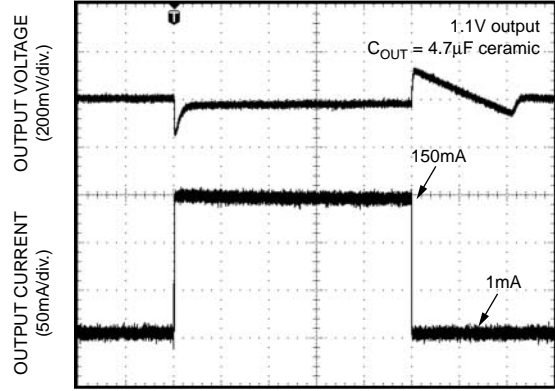

TIME (400 s/div.)

EN Turn-On Characteristic

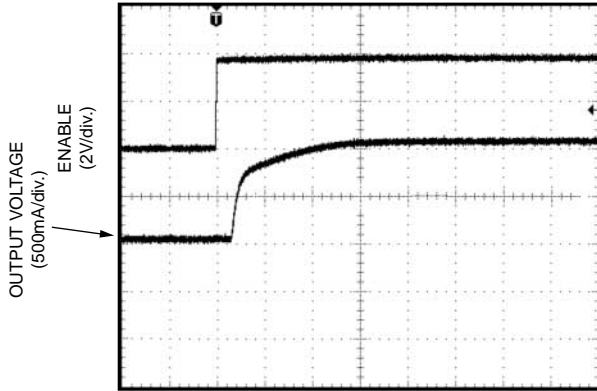

TIME (40 s/div.)

Load Transient Response

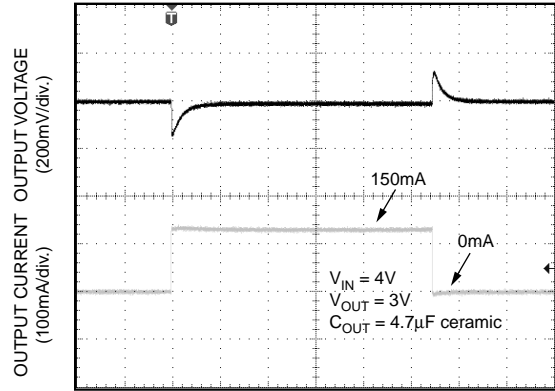

TIME (400µs/div.)

# Functional Diagram

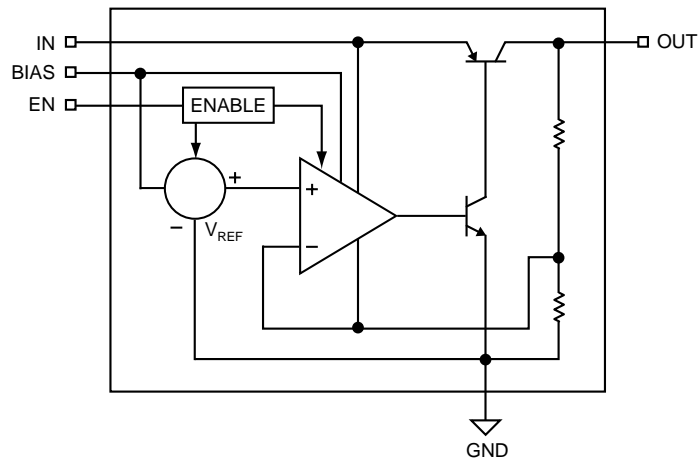

**Block Diagram – Fixed Output Voltage**

## Applications Information

### Enable/Shutdown

The MIC5238 comes with an active-high enable pin that allows the regulator to be disabled. Forcing the enable pin low disables the regulator and sends it into a “zero” off-mode-current state. In this state, current consumed by the regulator goes nearly to zero. Forcing the enable pin high enables the output voltage.

### Input Bias Capacitor

The input capacitor must be rated to sustain voltages that may be used on the input. An input capacitor may be required when the device is not near the source power supply or when supplied by a battery. Small, surface mount, ceramic capacitors can be used for bypassing. Larger values may be required if the source supply has high ripple.

### Output Capacitor

The MIC5238 requires an output capacitor for stability. The design requires 2.2 $\mu$ F or greater on the output to maintain stability. The design is optimized for use with low-ESR ceramic chip capacitors. High ESR capacitors may cause high frequency oscillation. The maximum recommended ESR is 3 $\Omega$ . The output capacitor can be increased without limit. Larger valued capacitors help to improve transient response.

X7R/X5R dielectric-type ceramic capacitors are recommended because of their temperature performance. X7R-type capacitors change capacitance by 15% over their operating temperature range and are the most stable type of ceramic capacitors. Z5U and Y5V dielectric capacitors change value by as much as 50% and 60% respectively over their operating temperature ranges. To use a ceramic chip capacitor with Y5V dielectric, the value must be much higher than a X7R ceramic capacitor to ensure the same minimum capacitance over the equivalent operating temperature range.

### No-Load Stability

The MIC5238 will remain stable and in regulation with no load unlike many other voltage regulators. This is especially important in CMOS RAM keep-alive applications.

### Thermal Considerations

The MIC5238 is designed to provide 150mA of continuous current in a very small package. Maximum power dissipation can be calculated based on the output current and the voltage drop across the part. To determine the maximum power dissipation of the package, use the junction-to-ambient thermal resistance of the device and the following basic equation:

$$P_{D(MAX)} = \left( \frac{T_{J(MAX)} - T_A}{\theta_{JA}} \right)$$

$T_{J(MAX)}$  is the maximum junction temperature of the die, 125°C, and  $T_A$  is the ambient operating temperature.  $\theta_{JA}$  is layout dependent; Table 1 shows the junction-to-ambient thermal resistance for the MIC5238.

Package	$\theta_{JA}$ Recommended Minimum Footprint
SOT-23-5	235°C/W

**Table 1. SOT-23-5 Thermal Resistance**

The actual power dissipation of the regulator circuit can be determined using the equation:

$$P_D = (V_{IN} - V_{OUT})I_{OUT} + V_{IN}I_{GND}$$

Substituting  $P_{D(MAX)}$  for  $P_D$  and solving for the operating conditions that are critical to the application will give the maximum operating conditions for the regulator circuit. For example, when operating the MIC5238-1.0BM5 at 50°C with a minimum footprint layout, the maximum input voltage for a set output current can be determined as follows:

$$P_{D(MAX)} = \left( \frac{125^\circ\text{C} - 50^\circ\text{C}}{235^\circ\text{C/W}} \right)$$

$$P_{D(MAX)} = 319\text{mW}$$

The junction-to-ambient ( $\theta_{JA}$ ) thermal resistance for the minimum footprint is 235°C/W, from Table 1. It is important that the maximum power dissipation not be exceeded to ensure proper operation. With very high input-to-output voltage differentials, the output current is limited by the total power dissipation. Total power dissipation is calculated using the following equation:

$$P_D = (V_{IN} - V_{OUT})I_{OUT} + V_{IN} \times I_{GND} + V_{BIAS} \times I_{BIAS}$$

Since the bias supply draws only 18 $\mu$ A, that contribution can be ignored for this calculation.

If we know the maximum load current, we can solve for the maximum input voltage using the maximum power dissipation calculated for a 50°C ambient, 319mW.

$$P_{D(MAX)} = (V_{IN} - V_{OUT})I_{OUT} + V_{IN} \times I_{GND}$$

$$319\text{mW} = (V_{IN} - 1\text{V})150\text{mA} + V_{IN} \times 2.8\text{mA}$$

Ground pin current is estimated using the typical characteristics of the device.

$$469\text{mW} = V_{IN} (152.8\text{mA})$$

$$V_{IN} = 3.07\text{V}$$

For higher current outputs only a lower input voltage will work for higher ambient temperatures.

Assuming a lower output current of 20mA, the maximum input voltage can be recalculated:

$$319\text{mW} = (V_{IN} - 1\text{V})20\text{mA} + V_{IN} \times 0.2\text{mA}$$

$$339\text{mW} = V_{IN} \times 20.2\text{mA}$$

$$V_{IN} = 16.8\text{V}$$

Maximum input voltage for a 20mA load current at 50°C ambient temperature is 16.8V. Since the device has a 6V rating, it will operate over the whole input range.

### Dual Supply Mode Efficiency

By utilizing a bias supply the conversion efficiency can be greatly enhanced. This can be realized as the higher bias supply will only consume a few  $\mu$ A's while the input supply will require a few mA's! This equates to higher efficiency saving valuable power in the system. As an example, consider an output voltage of 1V with an input supply of 2.5V at a load



current of 150mA. The input ground current under these conditions is 2mA, while the bias current is only 20 $\mu$ A. If we calculate the conversion efficiency using the single supply approach, it is as follows:

Input power =  $V_{IN} \times \text{output current} + V_{IN} \times (V_{BIAS} \text{ ground current} + V_{IN} \text{ ground current})$

Input power =  $2.5V \times 150mA + 2.5 \times (0.0002+0.002) = 380.5mW$

Output power =  $1V \times 0.15 = 150mW$

Efficiency =  $150/380.5 \times 100 = 39.4\%$

Now, using a lower input supply of 1.5V, and powering the bias voltage only from the 2.5V input, the efficiency is as follows:

Input power =  $V_{IN} \times \text{output current} + V_{IN} \times V_{IN} \text{ ground current} + V_{BIAS} \times V_{BIAS} \text{ ground current}$

Input power =  $1.5 \times 150mA + 1.5 \times 0.002 + 2.5 \times 0.0002 = 225mW$

Output power =  $1V \times 150mA = 150mW$

Efficiency =  $150/225 \times 100 = 66.6\%$

Therefore, by using the dual supply MIC5238 LDO the efficiency is nearly doubled over the single supply version.

This is a valuable asset in portable power management applications equating to longer battery life and less heat being generated in the application.

This in turn will allow a smaller footprint design and an extended operating life.

# Package Information

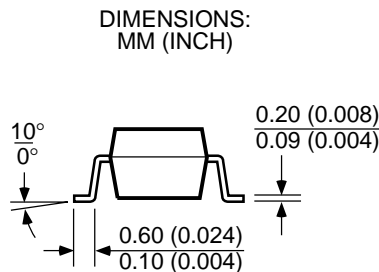
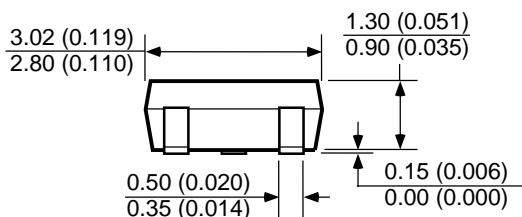
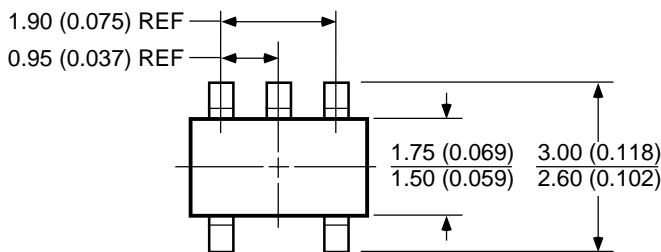

**SOT-23-5 (M5)**

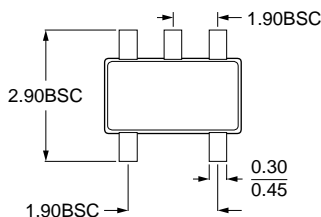

DIMENSIONS:  
Millimeter

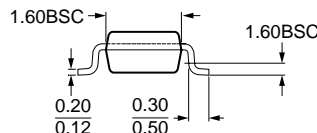
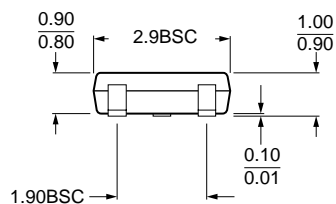

**TSOT-23-5 (D5)**

**MICREL, INC. 1849 FORTUNE DRIVE SAN JOSE, CA 95131 USA**

TEL + 1 (408) 944-0800 FAX + 1 (408) 944-0970 WEB <http://www.micrel.com>

The information furnished by Micrel in this datasheet is believed to be accurate and reliable. However, no responsibility is assumed by Micrel for its use. Micrel reserves the right to change circuitry and specifications at any time without notification to the customer.

Micrel Products are not designed or authorized for use as components in life support appliances, devices or systems where malfunction of a product can reasonably be expected to result in personal injury. Life support devices or systems are devices or systems that (a) are intended for surgical implant into the body or (b) support or sustain life, and whose failure to perform can be reasonably expected to result in a significant injury to the user. A Purchaser's use or sale of Micrel Products for use in life support appliances, devices or systems is at Purchaser's own risk and Purchaser agrees to fully indemnify Micrel for any damages resulting from such use or sale.

© 2003 Micrel, Incorporated.