

NDH8320C Dual N & P-Channel Enhancement Mode Field Effect Transistor

General Description

These dual N- and P-Channel enhancement mode power field effect transistors are produced using Fairchild's proprietary, high cell density, DMOS technology. This very high density process is especially tailored to minimize on-state resistance and provide superior switching performance. These devices are particularly suited for low voltage applications such as notebook computer power management and other battery powered circuits where fast switching, low in-line power loss, and resistance to transients are needed.

Features

- N-Channel 3 A, 20 V, $R_{DS(ON)}=0.06 \Omega @ V_{GS}=4.5 \text{ V}$
 $R_{DS(ON)}=0.075 \Omega @ V_{GS}=2.7 \text{ V}$ P-Channel -2A, -20V,
 $R_{DS(ON)}=0.13 \Omega @ V_{GS}=-4.5 \text{ V}$
 $R_{DS(ON)}=0.19 \Omega @ V_{GS}=-2.7 \text{ V}$.
- Proprietary SuperSOT™-8 package design using copper lead frame for superior thermal and electrical capabilities.
- High density cell design for extremely low $R_{DS(ON)}$.
- Exceptional on-resistance and maximum DC current capability.

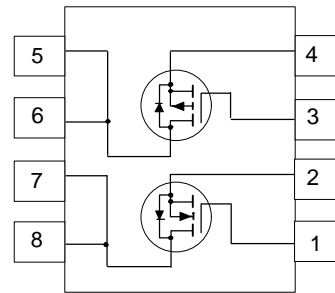
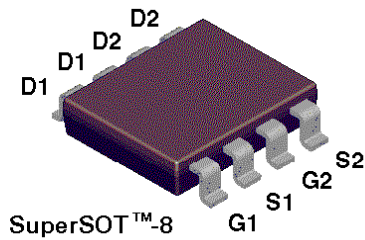

Absolute Maximum Ratings $T_A = 25^\circ\text{C}$ unless otherwise noted

Symbol	Parameter	N-Channel	P-Channel	Units
V_{DSS}	Drain-Source Voltage	20	-20	V
V_{GSS}	Gate-Source Voltage	8	-8	V
I_D	Drain Current - Continuous (Note 1)	3	-2	A
	- Pulsed	15	-10	
P_D	Power Dissipation for Single Operation (Note 1)	0.8		W
T_J, T_{STG}	Operating and Storage Temperature Range	-55 to 150		$^\circ\text{C}$

THERMAL CHARACTERISTICS

$R_{\theta JA}$	Thermal Resistance, Junction-to-Ambient (Note 1)	156	$^\circ\text{C/W}$
$R_{\theta JC}$	Thermal Resistance, Junction-to-Case (Note 1)	40	$^\circ\text{C/W}$

Electrical Characteristics ($T_A = 25^\circ\text{C}$ unless otherwise noted)

Symbol	Parameter	Conditions	Type	Min	Typ	Max	Units	
OFF CHARACTERISTICS								
BV_{DSS}	Drain-Source Breakdown Voltage	$V_{GS} = 0\text{ V}, I_D = 250\ \mu\text{A}$	N-Ch	20			V	
		$V_{GS} = 0\text{ V}, I_D = -250\ \mu\text{A}$	P-Ch	-20			V	
I_{DSS}	Zero Gate Voltage Drain Current	$V_{DS} = 16\text{ V}, V_{GS} = 0\text{ V}$	N-Ch			1	μA	
						10	μA	
		$V_{DS} = -16\text{ V}, V_{GS} = 0\text{ V}$	P-Ch			-1	μA	
						-10	μA	
I_{GSSF}	Gate - Body Leakage, Forward	$V_{GS} = 8\text{ V}, V_{DS} = 0\text{ V}$	All			100	nA	
I_{GSSR}	Gate - Body Leakage, Reverse	$V_{GS} = -8\text{ V}, V_{DS} = 0\text{ V}$	All			-100	nA	
ON CHARACTERISTICS (Note 2)								
$V_{GS(th)}$	Gate Threshold Voltage	$V_{DS} = V_{GS}, I_D = 250\ \mu\text{A}$	N-Ch	0.4	0.7	1	V	
				0.3	0.45	0.7		
		$V_{DS} = V_{GS}, I_D = -250\ \mu\text{A}$	P-Ch	-0.4	-0.6	-1		
				-0.3	-0.42	-0.7		
$R_{DS(on)}$	Static Drain-Source On-Resistance	$V_{GS} = 4.5\text{ V}, I_D = 3\text{ A}$	N-Ch		0.047	0.06	Ω	
					0.07	0.11		
		$V_{GS} = 2.7\text{ V}, I_D = 2.6\text{ A}$			0.059	0.075		
			P-Ch		0.102	0.13		
		$V_{GS} = -4.5\text{ V}, I_D = -2\text{ A}$			0.15	0.23		
					0.147	0.19		
$I_{D(on)}$	On-State Drain Current	$V_{GS} = 4.5\text{ V}, V_{DS} = 5\text{ V}$	N-Ch	15			A	
		$V_{GS} = 2.7\text{ V}, V_{DS} = 5\text{ V}$		5				
		$V_{GS} = -4.5\text{ V}, V_{DS} = -5\text{ V}$	P-Ch	-10				
		$V_{GS} = -2.7\text{ V}, V_{DS} = -5\text{ V}$		-4				
g_{FS}	Forward Transconductance	$V_{DS} = 5\text{ V}, I_D = 3\text{ A}$	N-Ch		10		S	
		$V_{DS} = -5\text{ V}, I_D = -2\text{ A}$	P-Ch		5			
DYNAMIC CHARACTERISTICS								
C_{iss}	Input Capacitance	N-Channel $V_{DS} = 10\text{ V}, V_{GS} = 0\text{ V},$ $f = 1.0\text{ MHz}$	N-Ch		415		pF	
			P-Ch		515			
C_{oss}	Output Capacitance		P-Channel $V_{DS} = -10\text{ V}, V_{GS} = 0\text{ V},$ $f = 1.0\text{ MHz}$	N-Ch		220		pF
				P-Ch		250		
C_{rss}	Reverse Transfer Capacitance			N-Ch		85		pF
				P-Ch		85		

Electrical Characteristics (T_A = 25°C unless otherwise noted)

Symbol	Parameter	Conditions	Type	Min	Typ	Max	Units
SWITCHING CHARACTERISTICS (Note 2)							
t _{D(on)}	Turn - On Delay Time	N-Channel V _{DD} = 5 V, I _D = 1 A, V _{GEN} = 4.5 V, R _{GEN} = 6 Ω	N-Ch		8	15	ns
			P-Ch		10	20	
t _r	Turn - On Rise Time	P-Channel V _{DD} = -5 V, I _D = -1 A, V _{GEN} = -4.5 V, R _{GEN} = 6 Ω	N-Ch		25	45	ns
			P-Ch		27	50	
t _{D(off)}	Turn - Off Delay Time		N-Ch		30	55	ns
			P-Ch		37	65	
t _f	Turn - Off Fall Time	N-Ch		8	15	ns	
		P-Ch		39	75		
Q _g	Total Gate Charge	N-Channel V _{DS} = 10 V, I _D = 3 A, V _{GS} = 4.5 V	N-Ch		10	15	nC
			P-Ch		7.8	11	
Q _{gs}	Gate-Source Charge	P-Channel V _{DS} = -10 V, I _D = -2 A, V _{GS} = -4.5 V	N-Ch		0.9		nC
			P-Ch		1.2		
Q _{gd}	Gate-Drain Charge	N-Ch		3.5		nC	
		P-Ch		1.8			
DRAIN-SOURCE DIODE CHARACTERISTICS AND MAXIMUM RATINGS							
I _S	Maximum Continuous Drain-Source Diode Forward Current		N-Ch			0.67	A
			P-Ch			-0.67	
V _{SD}	Drain-Source Diode Forward Voltage	V _{GS} = 0 V, I _S = 0.67 A (Note2)	N-Ch		0.7	1.2	V
		V _{GS} = 0 V, I _S = -0.67 A (Note2)	P-Ch		-0.75	-1.2	

Notes:

- R_{thJA} is the sum of the junction-to-case and case-to-ambient thermal resistance where the case thermal reference is defined as the solder mounting surface of the drain pins. R_{thJC} is guaranteed by design while R_{thCA} is determined by the user's board design.

$$P_D(t) = \frac{T_J - T_A}{R_{\theta J A}(t)} = \frac{T_J - T_A}{R_{\theta J C} + R_{\theta CA}(t)} = I_D^2(t) \times R_{DS(ON)} @ T_J$$

Typical R_{thJA} for single device operation using the board layout shown below on 4.5"x5" FR-4 PCB in a still air environment:

156°C/W when mounted on a 0.0025 in² pad of 2oz copper.

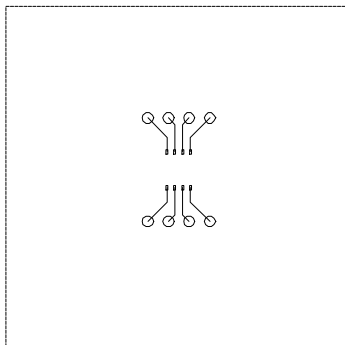

Scale 1 : 1 on letter size paper.

- Pulse Test: Pulse Width ≤ 300μs, Duty Cycle ≤ 2.0%.

Typical Electrical Characteristics: N-Channel

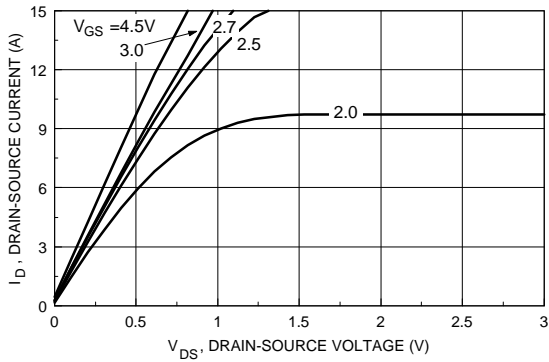

Figure 1. N-Channel On-Region Characteristics.

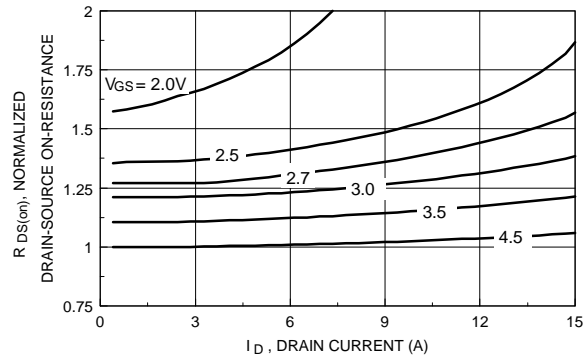

Figure 2. N-Channel On-Resistance Variation with Gate Voltage and Drain Current.

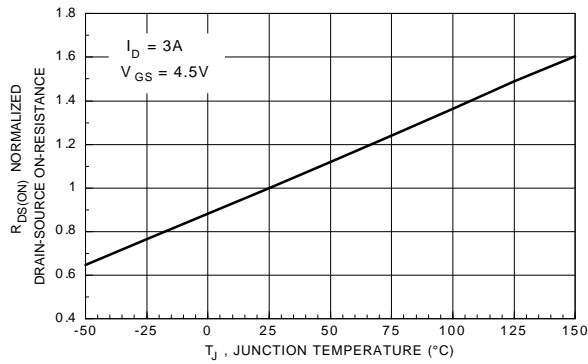

Figure 3. N-Channel On-Resistance Variation with Temperature.

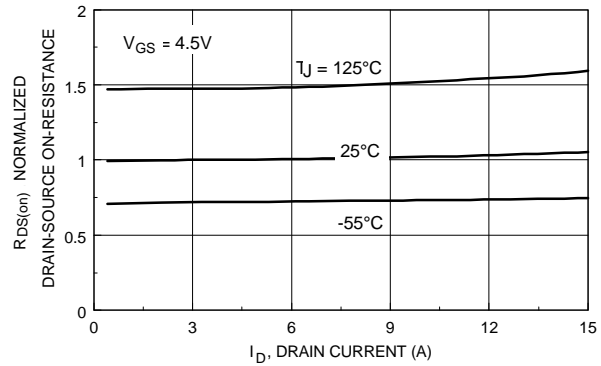

Figure 4. N-Channel On-Resistance Variation with Drain Current and Temperature.

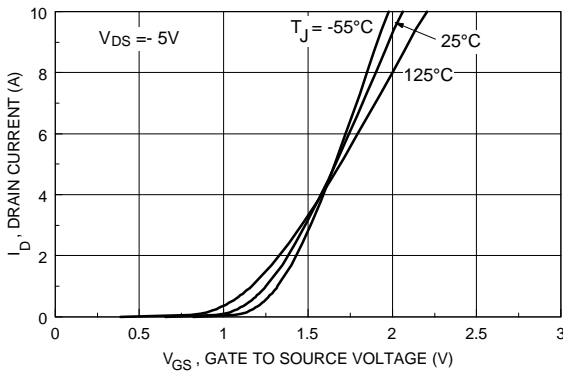

Figure 5. N-Channel Transfer Characteristics.

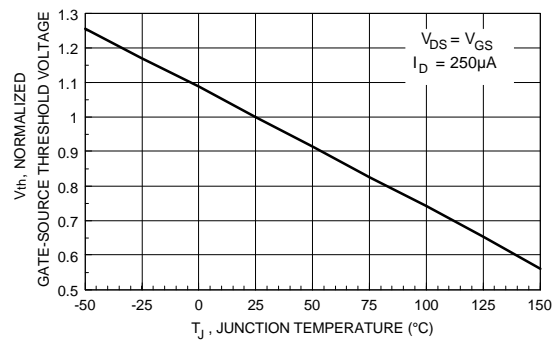

Figure 6. N-Channel Gate Threshold Variation with Temperature.

Typical Electrical Characteristics: N-Channel (continued)

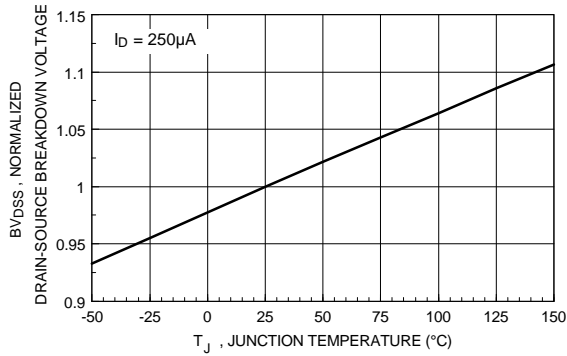

Figure 7. N-Channel Breakdown Voltage Variation with Temperature.

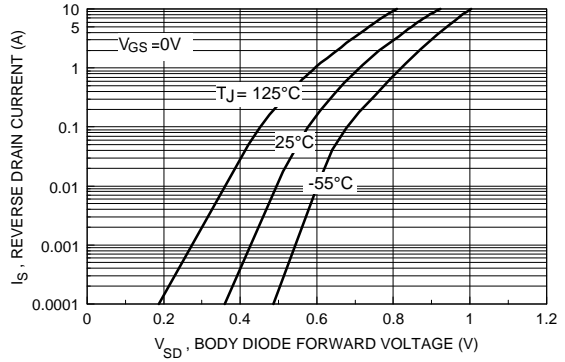

Figure 8. N-Channel Body Diode Forward Voltage Variation with Current and Temperature.

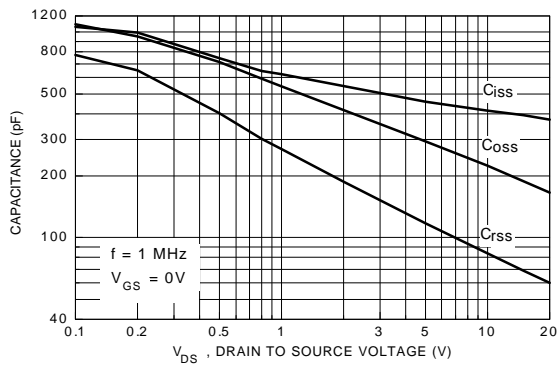

Figure 9. N-Channel Capacitance Characteristics.

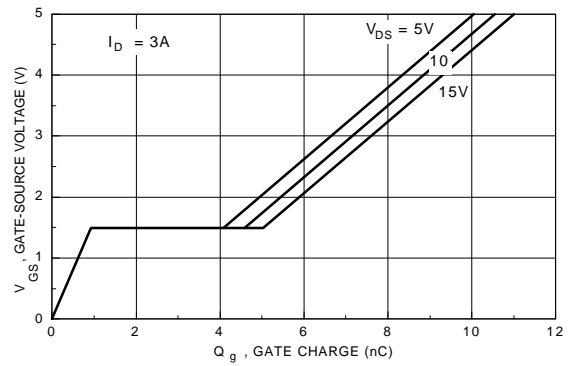

Figure 10. N-Channel Gate Charge Characteristics.

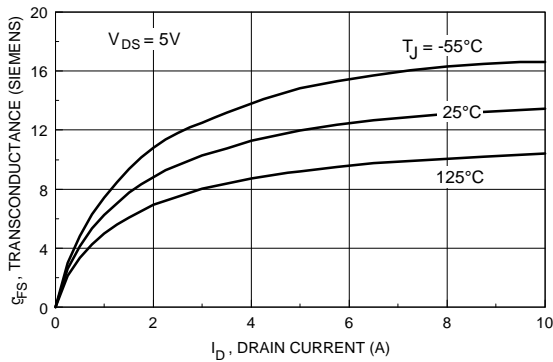

Figure 11. N-Channel Transconductance Variation with Drain Current and Temperature.

Typical Electrical Characteristics: P-Channel (continued)

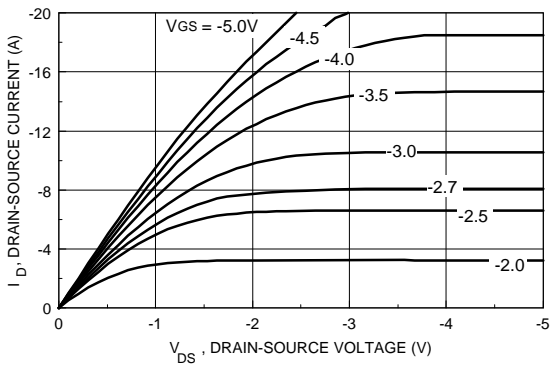

Figure 12. P-Channel On-Region Characteristics.

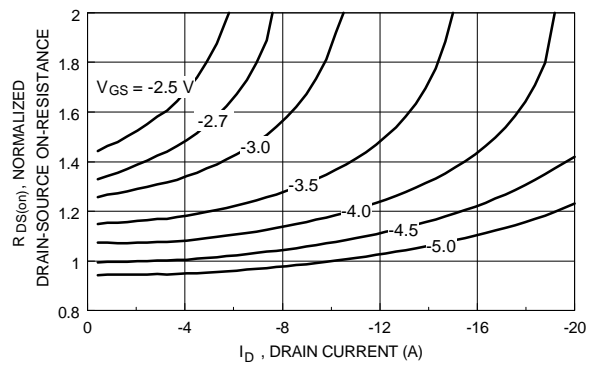

Figure 13. P-Channel On-Resistance Variation with Gate Voltage and Drain Current.

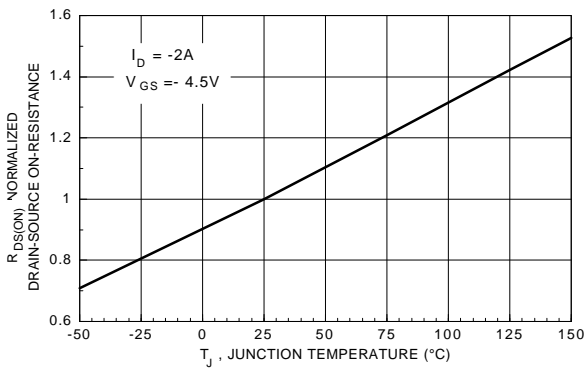

Figure 14. P-Channel On-Resistance Variation with Temperature.

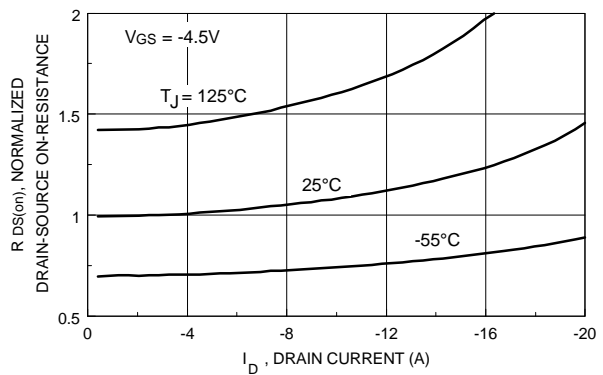

Figure 15. P-Channel On-Resistance Variation with Drain Current and Temperature.

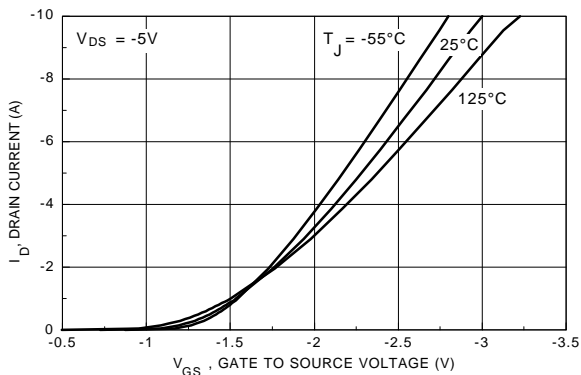

Figure 16. P-Channel Transfer Characteristics.

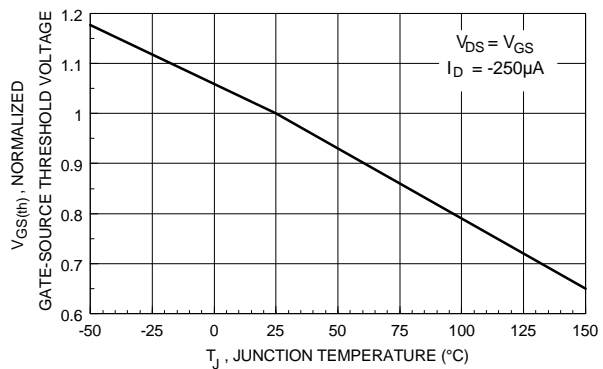

Figure 17. P-Channel Gate Threshold Variation with Temperature.

Typical Electrical Characteristics: P-Channel (continued)

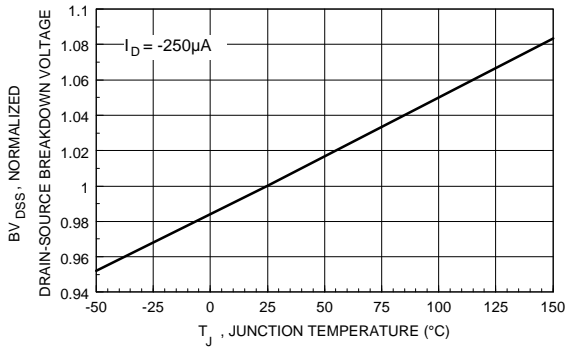

Figure 18. P-Channel Breakdown Voltage Variation with Temperature.

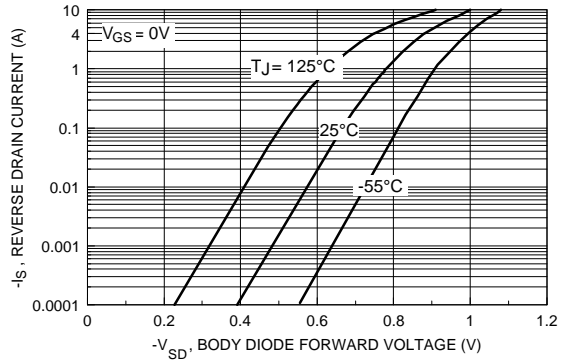

Figure 19. P-Channel Body Diode Forward Voltage Variation with Current and Temperature.

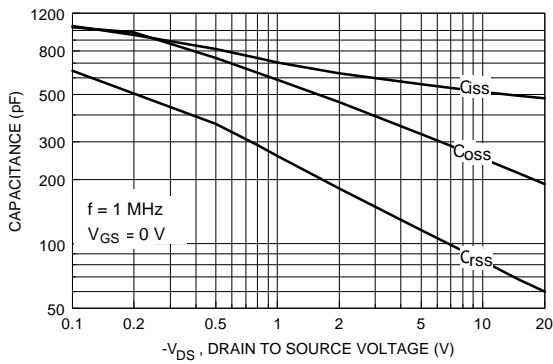

Figure 20. P-Channel Capacitance Characteristics.

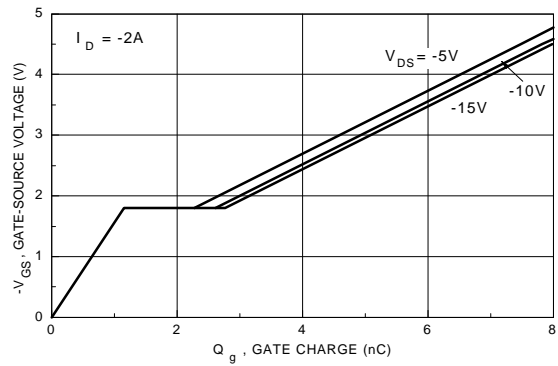

Figure 21. P-Channel Gate Charge Characteristics.

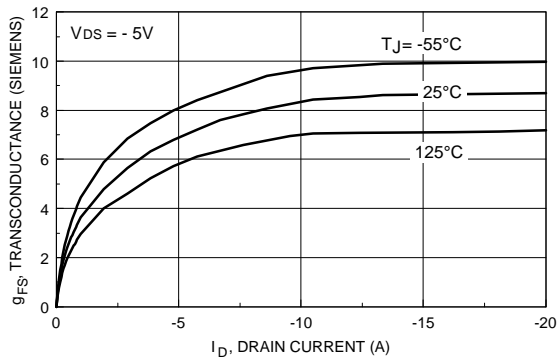

Figure 22. P-Channel Transconductance Variation with Drain Current and Temperature.

Typical Thermal Characteristics: N & P-Channel

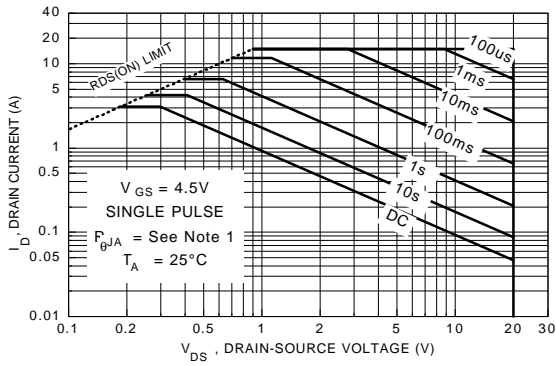

Figure 23. N-Channel Maximum Safe Operating Area.

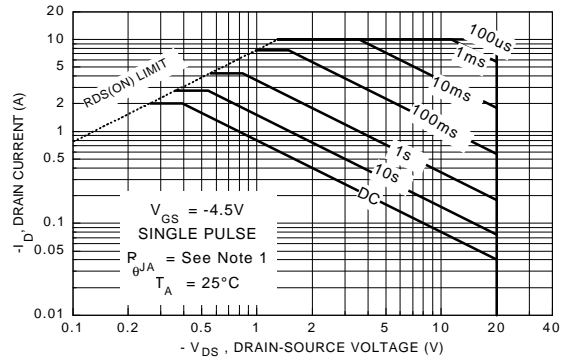

Figure 24. P-Channel Maximum Safe Operating Area.

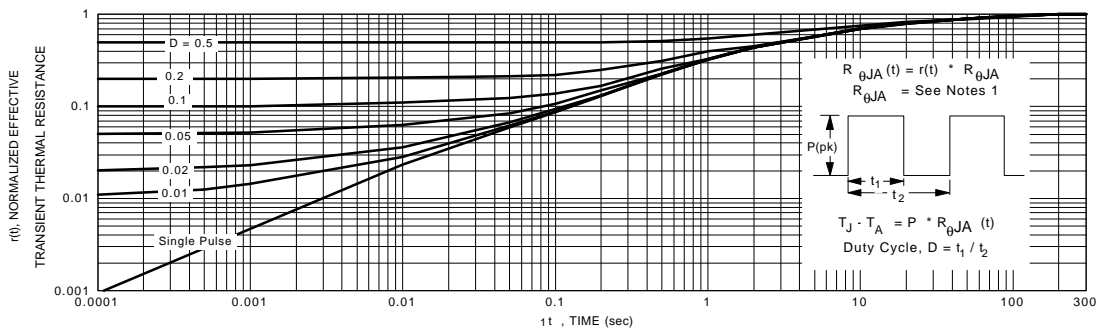

Figure 25. Transient Thermal Response Curve.

Note: Thermal characterization performed using the conditions described in note1. Transient thermal response will change depending on the circuit board design.

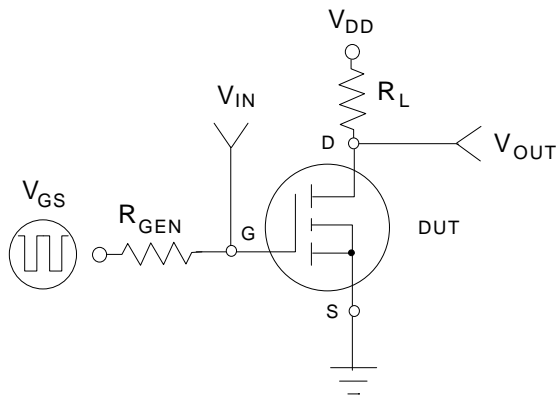

Figure 26. N or P-Channel Switching Test Circuit.

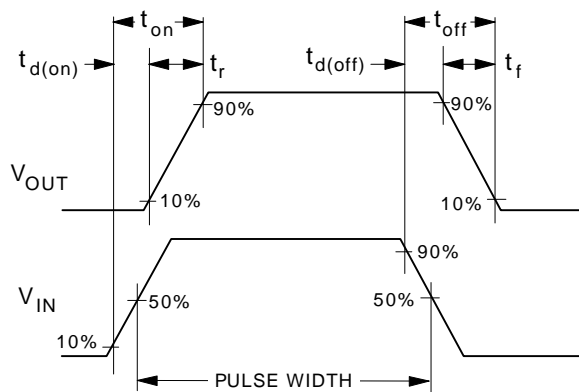

Figure 27. N or P-Channel Switching Waveforms.