

**Features**

- Logic AND/NAND input
- 3V and 5V Input compatible
- Clocking speeds up to 10 MHz
- 20 ns Switching/delay time
- 2A Peak drive
- Isolated drains
- Low output impedance
- Low quiescent current
- Wide operating voltage—4.5V–16V

**Applications**

- Short circuit protected switching
- Under-voltage shut-down circuits
- Switch-mode power supplies
- Motor controls
- Power MOSFET switching
- Switching capacitive loads
- Shoot-thru protection
- Latching drivers

**Ordering Information**

Part No.	Temp. Range	Pkg.	Outline #
EL7242CN	-40°C to +85°C	8-Pin P-DIP	MDP0031
EL7242CS	-40°C to +85°C	8-Pin SOIC	MDP0027
EL7252CN	-40°C to +85°C	8-Pin P-DIP	MDP0031
EL7252CS	-40°C to +85°C	8-Pin SOIC	MDP0027

**General Description**

The EL7242C/EL7252C dual input, 2-channel drivers achieve the same excellent switching performance of the EL7212 family while providing added flexibility. The 2-input logic and configuration is applicable to numerous power MOSFET drive circuits. As with other Elantec drivers, the EL7242C/EL7252C are excellent for driving large capacitive loads with minimal delay and switching times. "Shoot-thru" protection and latching circuits can be implemented by simply "cross-coupling" the 2-channels.

**Connection Diagrams**

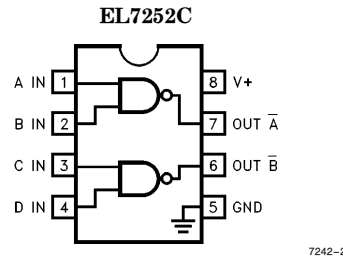
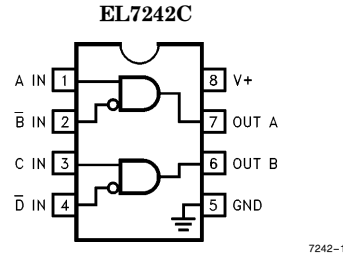

Manufactured under U.S. Patent Nos. 5,334,883, # 5,341,047

Note: All information contained in this data sheet has been carefully checked and is believed to be accurate as of the date of publication; however, this data sheet cannot be a "controlled document". Current revisions, if any, to these specifications are maintained at the factory and are available upon your request. We recommend checking the revision level before finalization of your design documentation.

# EL7242C/EL7252C

## Dual Input, High Speed, Dual Channel Power MOSFET Driver

### Absolute Maximum Ratings

Supply (V+ to Gnd)	16.5V	Operating Junction Temperature	125°C
Input Pins	-0.3V to +0.3V above V+	Power Dissipation	
Combined Peak Output Current	4A	SOIC	570 mW
Storage Temperature Range	-65°C to +150°C	PDIP	1050 mW
Ambient Operating Temperature	-40°C to +85°C		

#### Important Note:

All parameters having Min/Max specifications are guaranteed. The Test Level column indicates the specific device testing actually performed during production and Quality inspection. Elantec performs most electrical tests using modern high-speed automatic test equipment, specifically the LTX77 Series system. Unless otherwise noted, all tests are pulsed tests, therefore  $T_J = T_C = T_A$ .

Test Level	Test Procedure
I	100% production tested and QA sample tested per QA test plan QCX0002.
II	100% production tested at $T_A = 25^\circ\text{C}$ and QA sample tested at $T_A = 25^\circ\text{C}$ , $T_{MAX}$ and $T_{MIN}$ per QA test plan QCX0002.
III	QA sample tested per QA test plan QCX0002.
IV	Parameter is guaranteed (but not tested) by Design and Characterization Data.
V	Parameter is typical value at $T_A = 25^\circ\text{C}$ for information purposes only.

### DC Electrical Characteristics $T_A = 25^\circ\text{C}$ , $V = 15\text{V}$ unless otherwise specified

Parameter	Description	Test Conditions	Min	Typ	Max	Test Level	Units
<b>Input</b>							
$V_{IH}$	Logic "1" Input Voltage		2.4			I	V
$I_{IH}$	Logic "1" Input Current	@V+		0.1	10	I	$\mu\text{A}$
$V_{IL}$	Logic "0" Input Voltage				0.8	I	V
$I_{IL}$	Logic "0" Input Current	@0V		0.1	10	I	$\mu\text{A}$
$V_{HVS}$	Input Hysteresis			0.3		V	V
<b>Output</b>							
$R_{OH}$	Pull-Up Resistance	$I_{OUT} = -100\text{ mA}$		3	6	I	$\Omega$
$R_{OL}$	Pull-Down Resistance	$I_{OUT} = +100\text{ mA}$		4	6	I	$\Omega$
$I_{PK}$	Peak Output Current	Source Sink		2 2		IV	A
$I_{DC}$	Continuous Output Current	Source/Sink	100			I	mA
<b>Power Supply</b>							
$I_S$	Power Supply Current	Inputs High		1	2.5	I	mA
$V_S$	Operating Voltage		4.5		16	I	V

# EL7242C/EL7252C

## Dual Input, High Speed, Dual Channel Power MOSFET Driver

### AC Electrical Characteristics $T_A = 25^\circ\text{C}$ , $V = 15\text{V}$ unless otherwise specified

Parameter	Description	Test Conditions	Min	Typ	Max	Test Level	Units
<b>Switching Characteristics</b>							
$t_R$	Rise Time	$C_L = 500\text{ pF}$ $C_L = 1000\text{ pF}$			10 20	IV	ns
$t_F$	Fall Time	$C_L = 500\text{ pF}$ $C_L = 1000\text{ pF}$			10 20	IV	ns
$t_{D-ON}$	Turn-On Delay Time			20	25	IV	ns
$t_{D-OFF}$	Turn-Off Delay Time			20	25	IV	ns

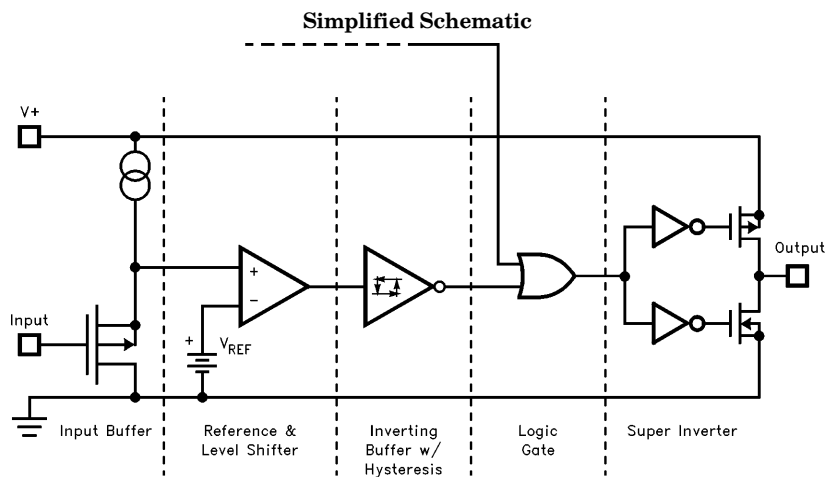
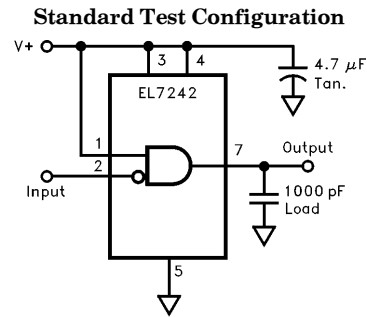
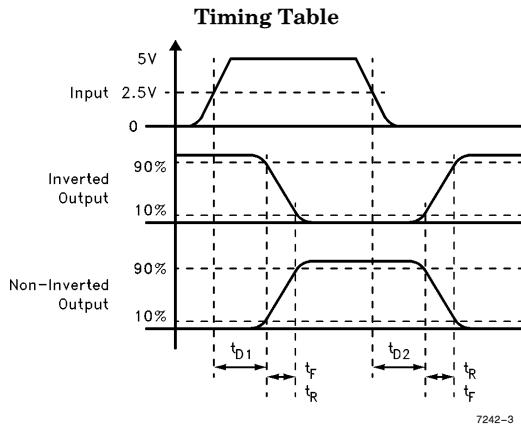

# EL7242C/EL7252C

## Dual Input, High Speed, Dual Channel Power MOSFET Driver

### Typical Performance Curve

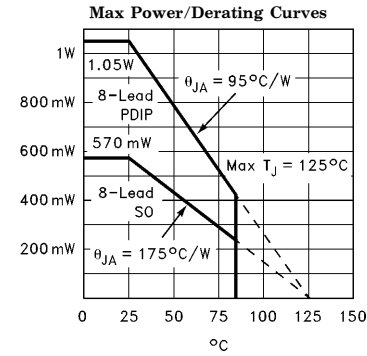

7242-17

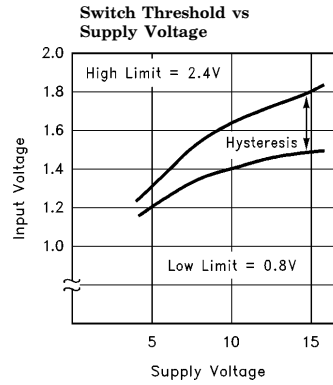

7242-6

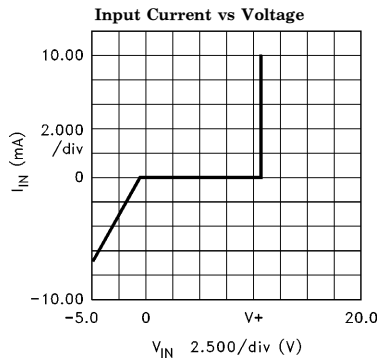

7242-7

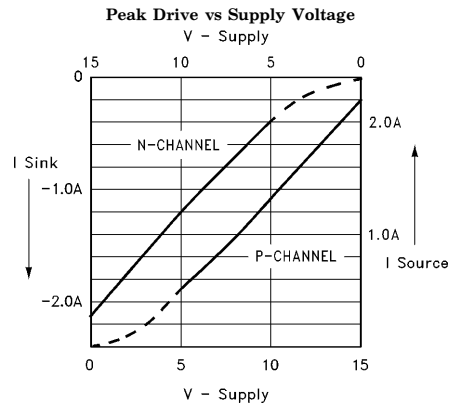

7242-8

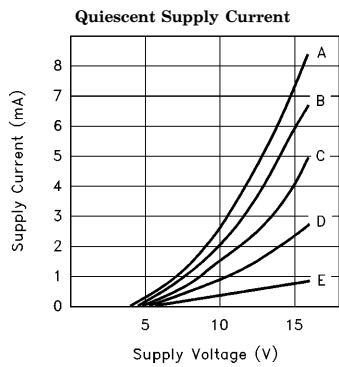

CASE:

A	ALL INPUTS GND
B	3 INPUTS GND
C	2 INPUTS GND
D	1 INPUT GND
E	ALL INPUTS V+

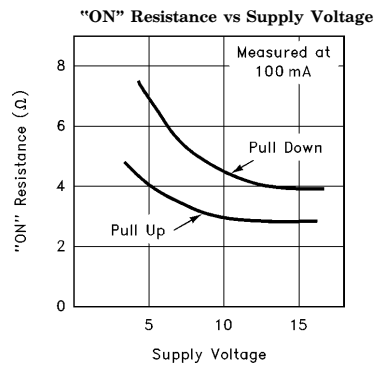

7242-9

7242-18

# EL7242C/EL7252C

## Dual Input, High Speed, Dual Channel Power MOSFET Driver

### Typical Performance Curve — Contd.

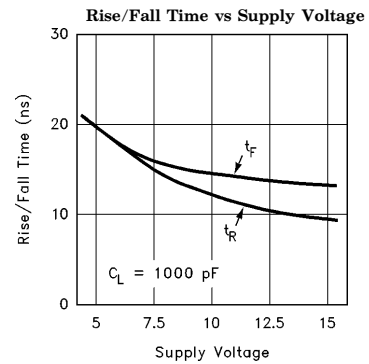
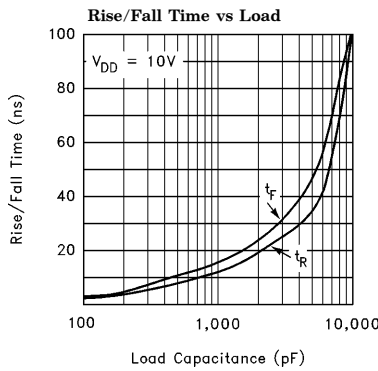
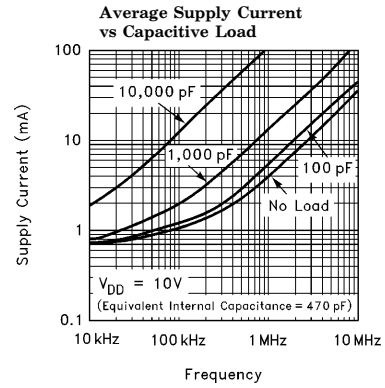
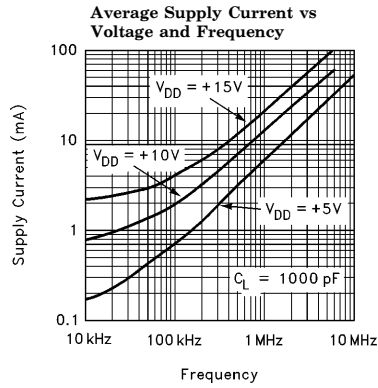

# EL7242C/EL7252C

## Dual Input, High Speed, Dual Channel Power MOSFET Driver

### Typical Performance Curve — Contd.

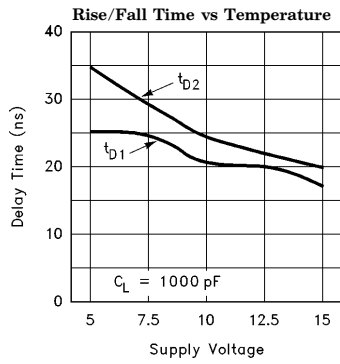

7242-13

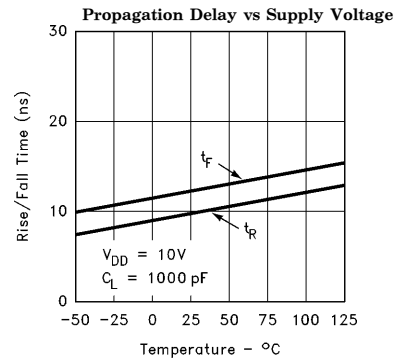

7242-14

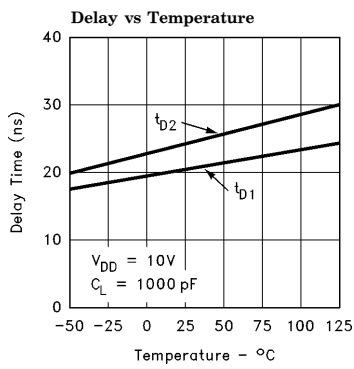

7242-15

**BLANK**

# ***EL7242C/EL7252C***

***Dual Input, High Speed, Dual Channel Power MOSFET Driver***

## **General Disclaimer**

Specifications contained in this data sheet are in effect as of the publication date shown. Elantec, Inc. reserves the right to make changes in the circuitry or specifications contained herein at any time without notice. Elantec, Inc. assumes no responsibility for the use of any circuits described herein and makes no representations that they are free from patent infringement.

***élantec***  
HIGH PERFORMANCE ANALOG INTEGRATED CIRCUITS

## **Elantec, Inc.**

1996 Tarob Court

Milpitas, CA 95035

Telephone: (408) 945-1323

(800) 333-6314

Fax: (408) 945-9305

European Office: 44-71-482-4596

## **WARNING — Life Support Policy**

Elantec, Inc. products are not authorized for and should not be used within Life Support Systems without the specific written consent of Elantec, Inc. Life Support systems are equipment intended to support or sustain life and whose failure to perform when properly used in accordance with instructions provided can be reasonably expected to result in significant personal injury or death. Users contemplating application of Elantec, Inc. products in Life Support Systems are requested to contact Elantec, Inc. factory headquarters to establish suitable terms & conditions for these applications. Elantec, Inc.'s warranty is limited to replacement of defective components and does not cover injury to persons or property or other consequential damages.