

TOSHIBA Bipolar Linear Integrated Circuit Silicon Monolithic

# TA8207K

## Low Frequency Power Amplifier

TA8207K is an audio power IC with built-in two channels developed for portable radio cassette tape recorder with power on / off switch.

Because of the parts reduction and SIP (single inline package), space merit is remarkable.

Thermal shut down protection circuit is built in.

### Features

- High power:  $P_{OUT} = 2.5W$  (typ.)  
( $V_{CC} = 9V$ ,  $R_L = 4\Omega$ ,  $f = 1kHz$ , THD = 10%)  
 $P_{OUT} = 4.6W$  (typ.)  
( $V_{CC} = 12V$ ,  $R_L = 4\Omega$ ,  $f = 1kHz$ , THD = 10%)
- Low popping noise at power on
- Small quiescent current:  $I_{CCQ} = 21mA$  (typ.) ( $V_{CC} = 9V$ ,  $V_{IN} = 0$ )
- Soft clip
- Built-in thermal shut down protection circuit
- Best for supply voltage 9V, 12V
- Operation supply voltage range:  $V_{CC} = 6\sim 15V$

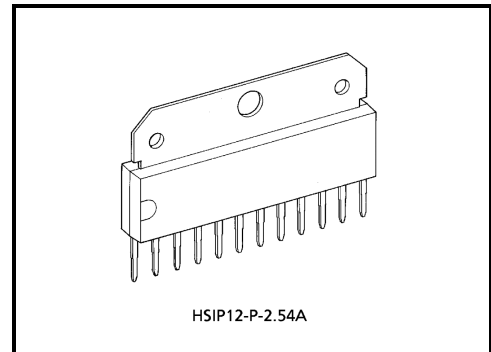

Weight: 3.2g (typ.)

## Maximum Ratings (Ta = 25°C)

Characteristic	Symbol	Rating	Unit
Supply voltage	V <sub>CC</sub>	20	V
Output current (peak / CH)	I <sub>O (peak)</sub>	2.5	A
Power dissipation	P <sub>D</sub>	12.5	W
Operating temperature	T <sub>opr</sub>	-20~75	°C
Storage temperature	T <sub>stg</sub>	-55~150	°C

## Electrical Characteristics

(unless otherwise specified, V<sub>CC</sub> = 9V, R<sub>L</sub> = 4Ω, R<sub>g</sub> = 600Ω, f = 1kHz, Ta = 25°C, R<sub>f</sub> = 120Ω)

Characteristic	Symbol	Test Circuit	Test Condition	Min.	Typ.	Max.	Unit
Quiescent current	I <sub>CCQ</sub>	—	V <sub>IN</sub> = 0	—	21	45	mA
Output power	P <sub>OUT (1)</sub>	—	THD = 10%	2.0	2.5	—	W
	P <sub>OUT (2)</sub>	—	THD = 10%, V <sub>CC</sub> = 12V	—	4.6	—	
Total harmonic distortion	THD	—	P <sub>OUT</sub> = 0.4W / ch	—	0.2	1.0	%
Voltage gain	G <sub>V (1)</sub>	—	R <sub>f</sub> = 120Ω, V <sub>OUT</sub> = 0.775V <sub>rms</sub> (0 dBm)	43	45	47	dB
	G <sub>V (2)</sub>	—	R <sub>f</sub> = 0, V <sub>OUT</sub> = 0.775V <sub>rms</sub> (0 dBm)	—	56.5	—	
Input resistance	R <sub>IN</sub>	—	—	—	30	—	kΩ
Output noise voltage	V <sub>NO</sub>	—	R <sub>g</sub> = 10kΩ, BW = 20Hz~20kHz	—	0.3	1.0	mV <sub>rms</sub>
Ripple rejection ratio	R.R.	—	R <sub>g</sub> = 600Ω, f <sub>ripple</sub> = 100Hz	—	52	—	dB
Cross talk	C.T.	—	R <sub>g</sub> = 600Ω, アンプ 1↔2, V <sub>o</sub> = 0.775V <sub>rms</sub> (0 dBm), f = 1kHz	—	50	—	dB
Input offset voltage	V <sub>6, V7</sub>	—	—	—	30	60	mV
Stand-by current	I <sub>OFF</sub>	—	SW <sub>1</sub> →off	—	1	—	μA

## Typical DC Voltage Of Each Terminal (V<sub>CC</sub> = 9V, Ta = 25°C)

Terminal no.	1	2	3	4	5	6	7	8	9	10	11	12
DC voltage	8.7	4.5	V <sub>CC</sub>	5.0	0.7	0.03	0.03	0.7	GND	4.5	8.7	V <sub>CC</sub>

## Block Diagram / Test Circuit

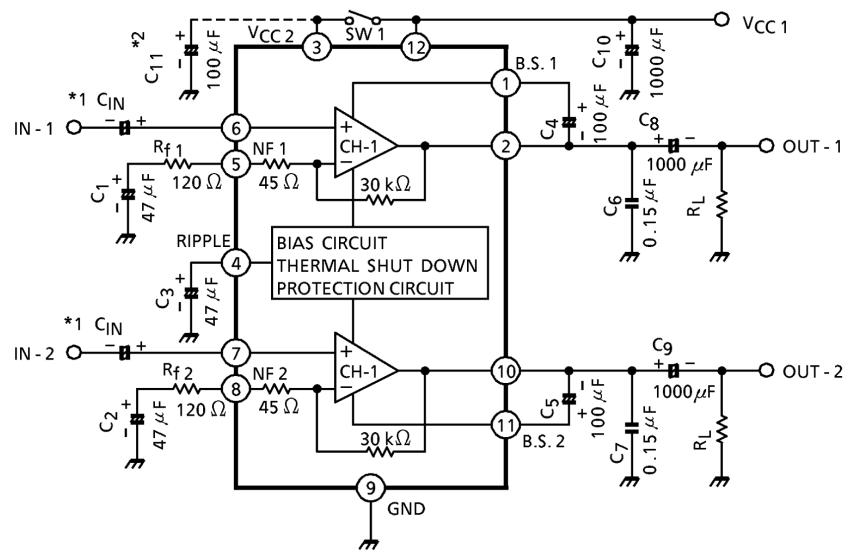

(\*1): This IC can be used without coupling capacitor ( $C_{IN}$ ). If volume slide noise occurred by input offset voltage is undesirable, it needs to use the capacitor ( $C_{IN}$ ).

(\*2): The condenser between the (3) pin and the GND ( $C_{11}$ ) is for reducing pop noise when the power on / off switch ( $SW_1$ ) is set to on / off.

**Application Information And Application Method**

1. Adjustment of voltage gain

The voltage gain  $G_V$  is obtained as follows by  $R_1$ ,  $R_2$  and  $R_f$  in Fig. 1.

$$G_V = 20 \log \frac{R_f + R_1 + R_2}{R_f + R_1}$$

When  $R_f = 0\Omega$   $G_V = 56.5\text{dB}$  (typ.)

When  $R_f = 120\Omega$   $G_V = 45\text{dB}$  (typ.)

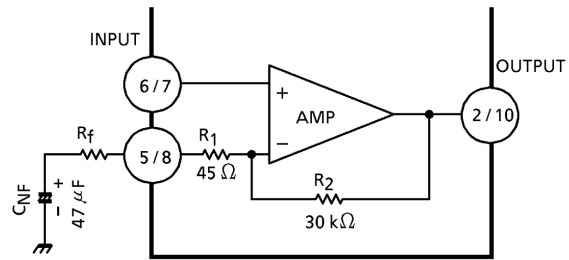

(Fig.1)

By increasing  $R_f$ , reduction of  $G_V$  is possible. However, since the feedback increase is liable to produce oscillation, it is recommended to use this at 40dB or over.

2. Thermal shut-down circuit

The thermal shut-down circuit is built in for the purpose of preventing the destruction of IC due to the abnormal temperature rise when the heat radiation is insufficient.

The operation temperature is set at radiation fin temperature  $175^\circ\text{C}$  (typ.).

At this temperature or over the bias is interrupted to prevent the destruction of IC.

3. Input stage

The input circuit of this IC is as shown in Fig.2.

PNP Tr: Q1 is provided in the input circuit so as to make its usage possible without the input coupling capacitor. However, at pin(6) and (7), max 60mV offset voltage is produced.

Application after checking volume slide noise is recommended.

For cutting the volume slide noise, insert the input capacitor:  $C_{IN}$  in series to interrupt the DC component.

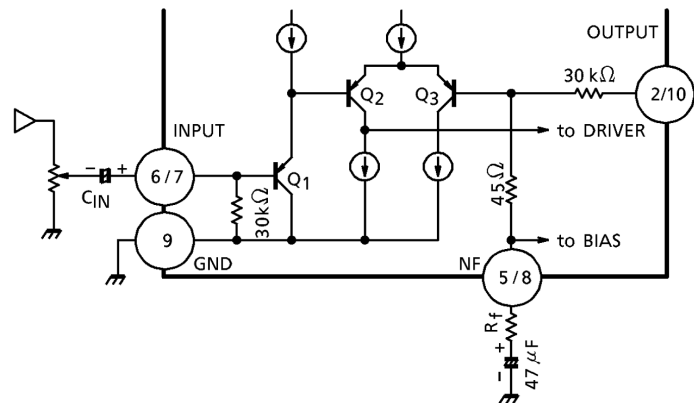

(Fig.2)

4. Oscillation preventive measures

For oscillation preventive capacitor  $C_6$  and  $C_7$  between the output terminal and GND, it is recommended to use polyester film capacitor having good characteristics for temperature and for high frequency.

Since the characteristics of the capacitor is liable to be influenced by the temperature, use this capacitor after the temperature test to check the oscillation allowance.

In addition, as the position of the electrolytic capacitor has remarkable influence on the oscillation, connect  $C_{10}$  to VCC at the nearest possible position from power GND.

At using this application with the voltage gain reduced, oscillation is liable to be produced.

Apply the capacitor after checking enough for its capacity, type and mounting position.

(\*): As the oscillation allowance varies according to the printed pattern layout, the standard printed board of TOSHIBA is recommended to be referend to design it.

5. Power on / off switch  
 There is power on / off switch at (3) pin. However, output power is changed by (3) pin supply voltage when (3) pin supply voltage is not same (12) pin supply voltage, after referring to attached date, select (3) pin supply voltage.
  
6. Input voltage  
 When the excessive signal is input, turning-up is produced in the clip waveform. The turning-up point is  $V_{IN} = 300mV_{RMS}$  (typ.):  $V_{CC} = 9V$ ,  $R_L = 4\Omega$ ,  $f = 1kHz$ : Enough care must be taken for this phenomenon.
  
7. GND line  
 GND pin is not separated for pre-GND and for PW-GND. That is liable to cause distortion and cross talk worse. Before use this IC, please check it.

**Standard Print Pattern**

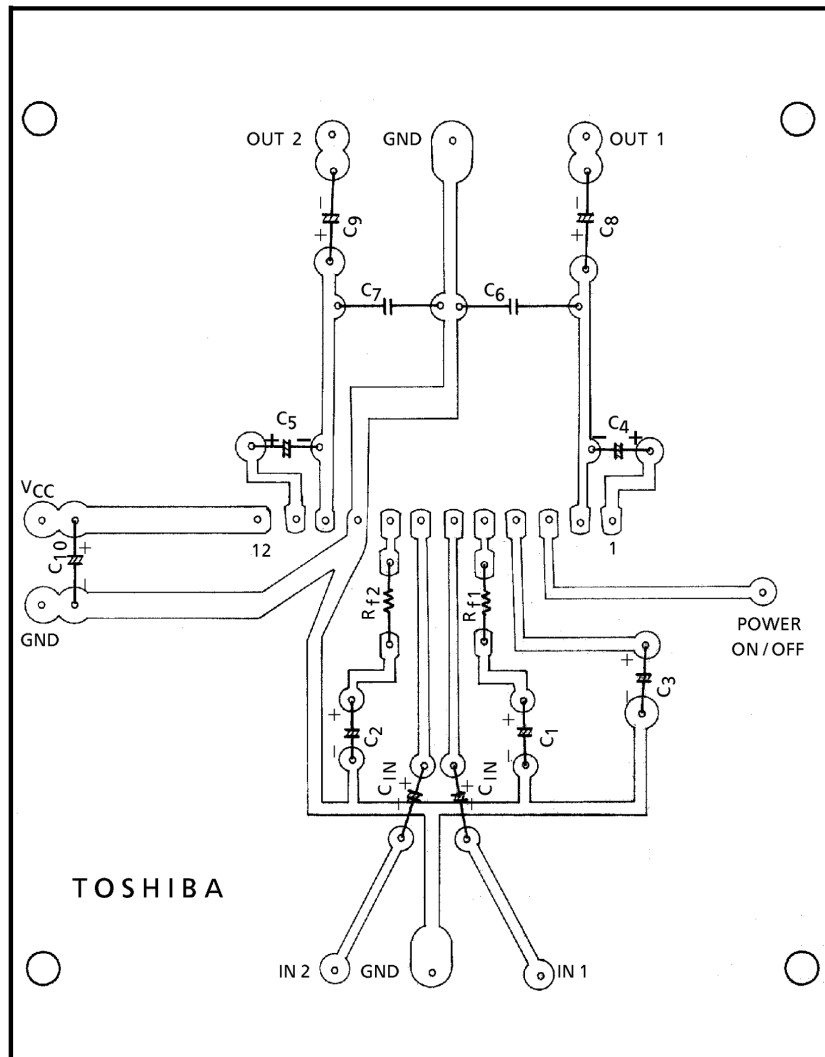

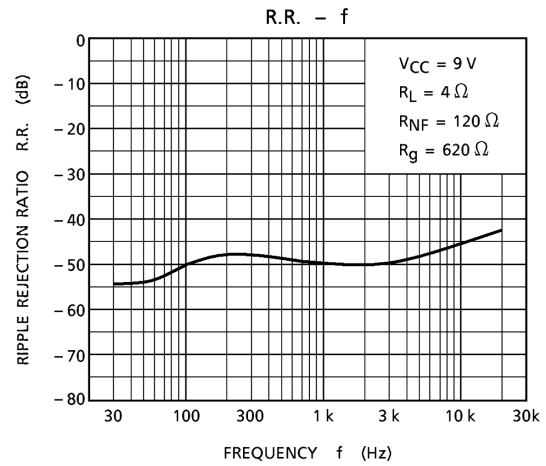
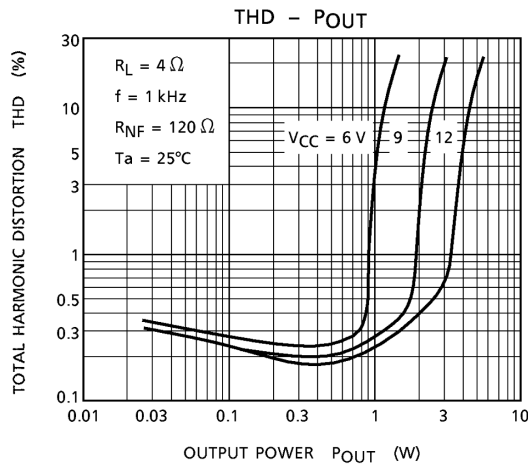
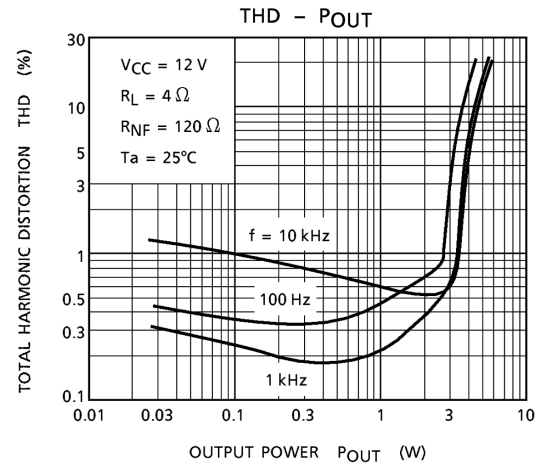
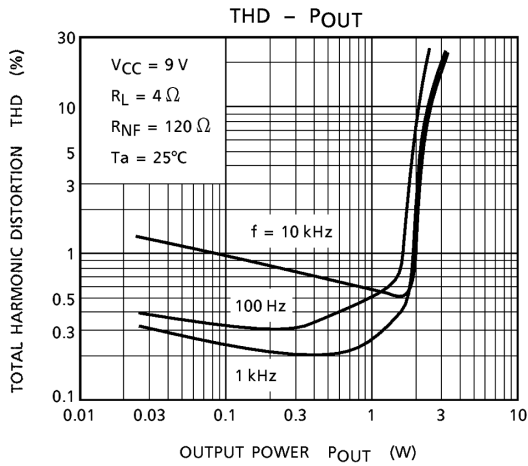
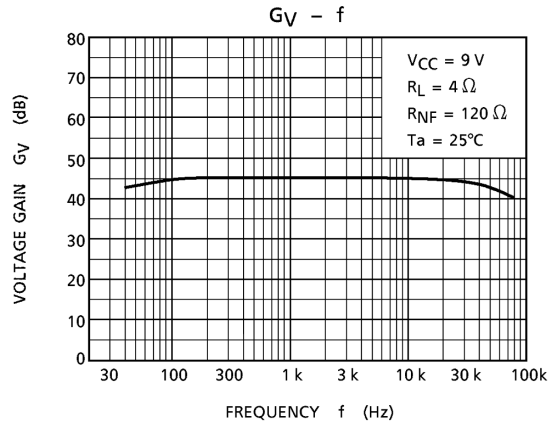
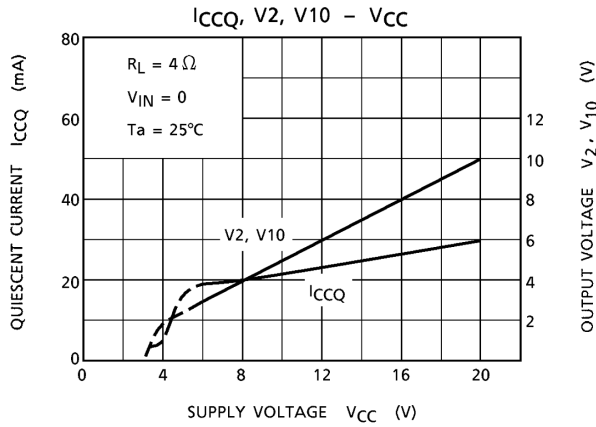

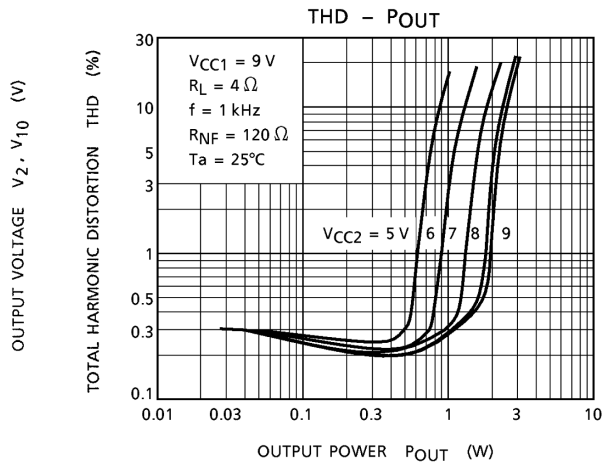
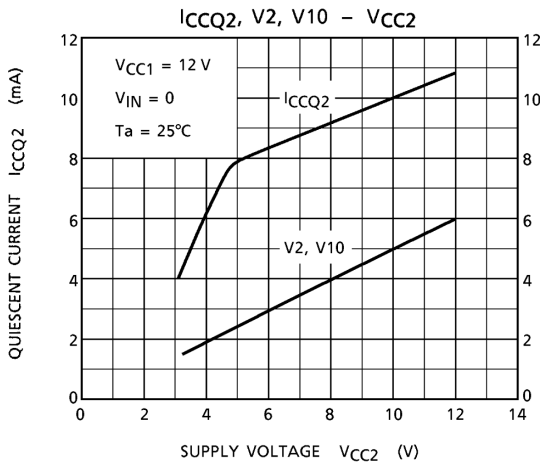
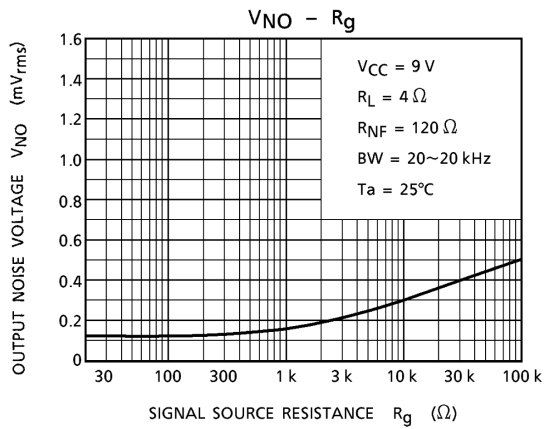
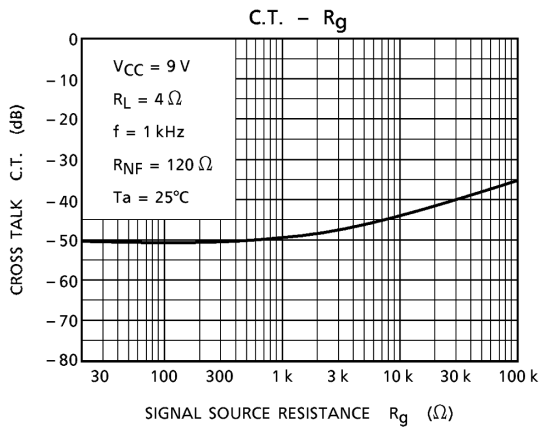
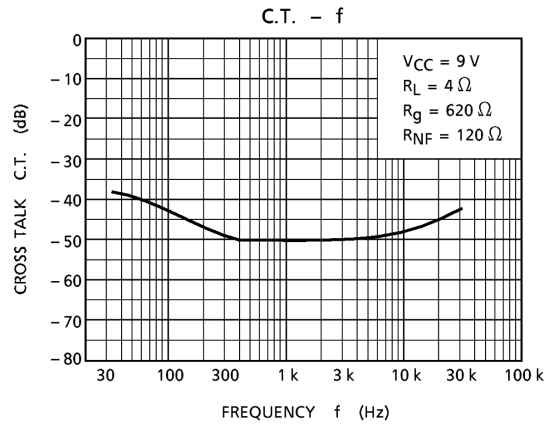
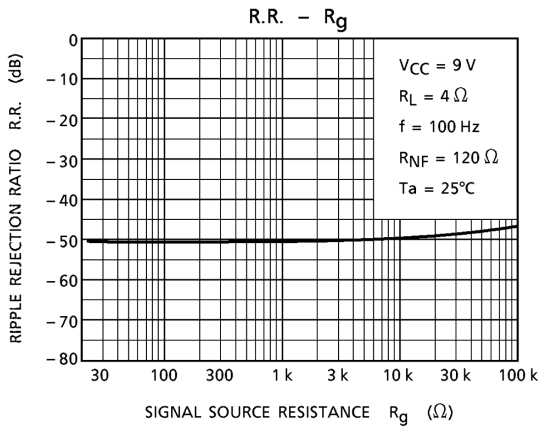

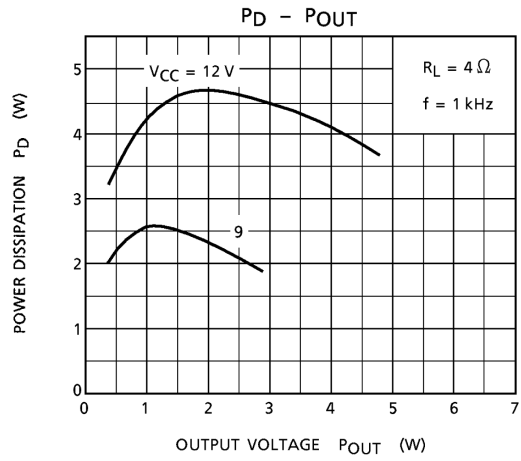
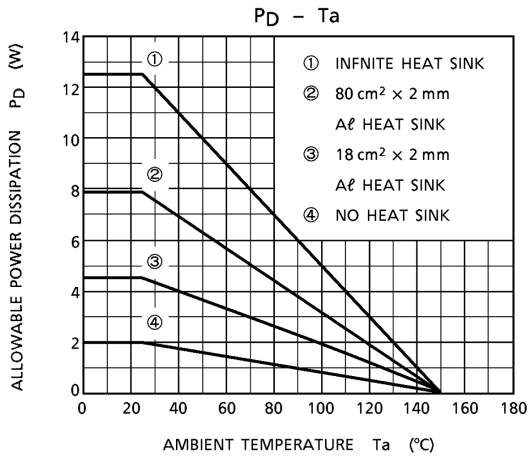
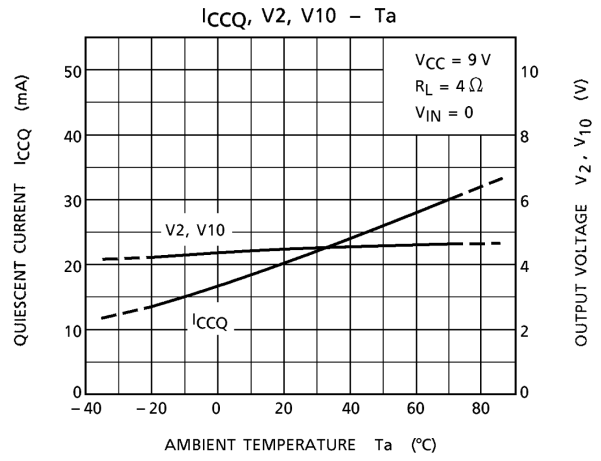
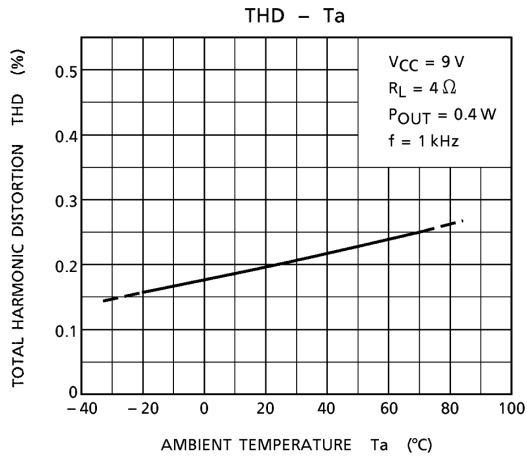



**Package Dimensions**

HSIP12-P-2.54A

Unit : mm

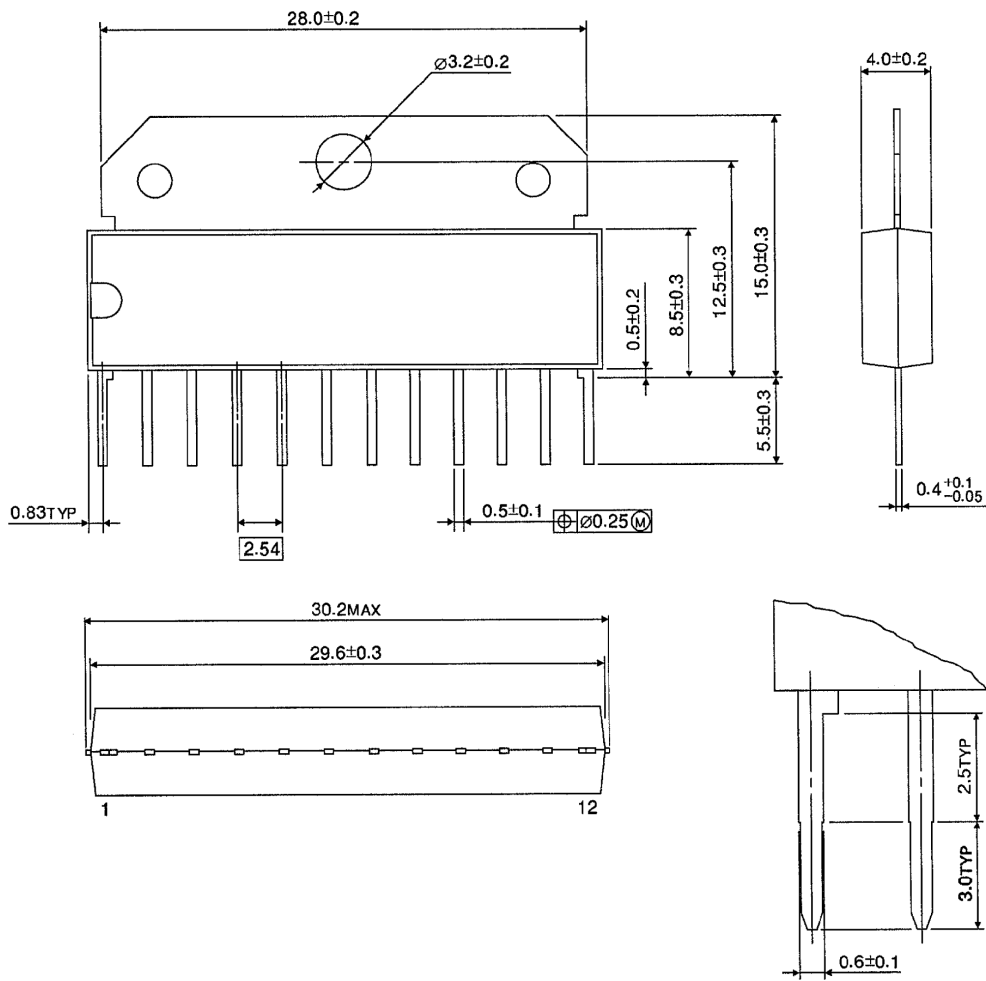

Weight: 3.2g (typ.)

**RESTRICTIONS ON PRODUCT USE**

000707EBF

- TOSHIBA is continually working to improve the quality and reliability of its products. Nevertheless, semiconductor devices in general can malfunction or fail due to their inherent electrical sensitivity and vulnerability to physical stress. It is the responsibility of the buyer, when utilizing TOSHIBA products, to comply with the standards of safety in making a safe design for the entire system, and to avoid situations in which a malfunction or failure of such TOSHIBA products could cause loss of human life, bodily injury or damage to property.  
In developing your designs, please ensure that TOSHIBA products are used within specified operating ranges as set forth in the most recent TOSHIBA products specifications. Also, please keep in mind the precautions and conditions set forth in the "Handling Guide for Semiconductor Devices," or "TOSHIBA Semiconductor Reliability Handbook" etc..
- The TOSHIBA products listed in this document are intended for usage in general electronics applications (computer, personal equipment, office equipment, measuring equipment, industrial robotics, domestic appliances, etc.). These TOSHIBA products are neither intended nor warranted for usage in equipment that requires extraordinarily high quality and/or reliability or a malfunction or failure of which may cause loss of human life or bodily injury ("Unintended Usage"). Unintended Usage include atomic energy control instruments, airplane or spaceship instruments, transportation instruments, traffic signal instruments, combustion control instruments, medical instruments, all types of safety devices, etc.. Unintended Usage of TOSHIBA products listed in this document shall be made at the customer's own risk.
- This product generates heat during normal operation. However, substandard performance or malfunction may cause the product and its peripherals to reach abnormally high temperatures.  
The product is often the final stage (the external output stage) of a circuit. Substandard performance or malfunction of the destination device to which the circuit supplies output may cause damage to the circuit or to the product.
- The products described in this document are subject to the foreign exchange and foreign trade laws.
- The information contained herein is presented only as a guide for the applications of our products. No responsibility is assumed by TOSHIBA CORPORATION for any infringements of intellectual property or other rights of the third parties which may result from its use. No license is granted by implication or otherwise under any intellectual property or other rights of TOSHIBA CORPORATION or others.
- The information contained herein is subject to change without notice.