

## AD1582/AD1583/AD1584/AD1585

### FEATURES

**Series Reference (2.5 V, 3 V, 4.096 V, 5 V)**  
**Initial Accuracy:  $\pm 0.1\%$  max**  
**Temperature Drift:  $\pm 50$  ppm/ $^{\circ}\text{C}$  max**  
**Low Quiescent Current: 65  $\mu\text{A}$  max**  
**Current Output Capability:  $\pm 5$  mA**  
**Wide Supply Range:  $V_{\text{IN}} = V_{\text{OUT}} + 200$  mV to 12 V**  
**Wideband Noise (10 Hz–10 kHz): 50  $\mu\text{V}$  rms**  
**Operating Temperature Range:  $-40^{\circ}\text{C}$  to  $+85^{\circ}\text{C}$**   
**Compact, Surface-Mount, SOT-23 Package**

### FUNCTIONAL BLOCK DIAGRAM

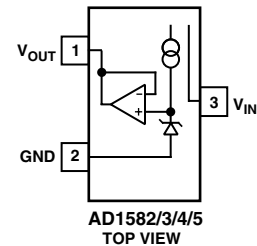

### GENERAL DESCRIPTION

The AD1582, AD1583, AD1584 and AD1585 are a family of low cost, low power, low dropout, precision bandgap references. These designs are available as three-terminal (series) devices and are packaged in the compact SOT-23, 3-pin, surface mount package. The versatility of these references makes them ideal for use in battery powered 3 V or 5 V systems where there may be wide variations in supply voltage and a need to minimize power dissipation.

The superior accuracy and temperature stability of the AD1582/AD1583/AD1584/AD1585 is made possible by the precise matching and thermal tracking of on-chip components. Patented temperature drift curvature correction design techniques have been used to minimize the nonlinearities in the voltage output temperature characteristic.

These series mode devices (AD1582/AD1583/AD1584/AD1585) will source or sink up to 5 mA of load current and operate efficiently with only 200 mV of required headroom. This family will draw a maximum 65  $\mu\text{A}$  of quiescent current with only a 1.0  $\mu\text{A}/\text{V}$  variation with supply voltage. The advantage of these designs over conventional shunt devices is extraordinary. Valuable supply current is no longer wasted through an input series resistor and maximum power efficiency is achieved at all input voltage levels.

The AD1582, AD1583, AD1584 and AD1585 are available in two grades, A and B, both of which are provided in the smallest available package on the market, the SOT-23. Both grades are specified over the industrial temperature range of  $-40^{\circ}\text{C}$  to  $+85^{\circ}\text{C}$ .

### TARGET APPLICATIONS

1. Portable, Battery Powered Equipment. Notebook Computers, Cellular Phones, Pagers, PDAs, GPSs and DMMs.
2. Computer Workstations. Suitable for use with a wide range of video RAMDACs.
3. Smart Industrial Transmitters.
4. PCMCIA Cards.
5. Automotive.
6. Hard Disk Drives.
7. 3 V/5 V 8-Bit–12-Bit Data Converters.

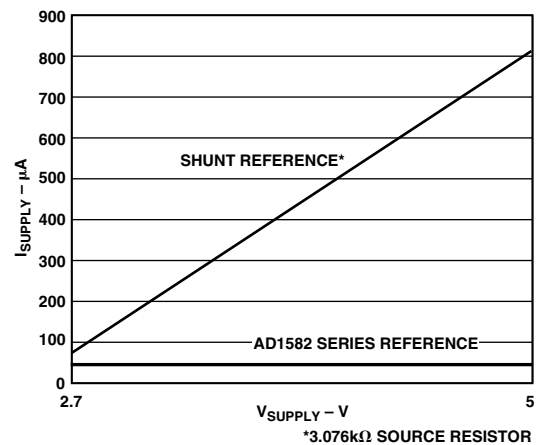

Figure 1. Supply Current ( $\mu\text{A}$ ) vs. Supply Voltage (V)

### REV. A

Information furnished by Analog Devices is believed to be accurate and reliable. However, no responsibility is assumed by Analog Devices for its use, nor for any infringements of patents or other rights of third parties which may result from its use. No license is granted by implication or otherwise under any patent or patent rights of Analog Devices.

# AD1582/AD1583/AD1584/AD1585

## AD1582—SPECIFICATIONS (@ $T_A = T_{MIN}-T_{MAX}$ , $V_{IN} = 5\text{ V}$ , unless otherwise noted)

Model	AD1582A			AD1582B			Units
	Min	Typ	Max	Min	Typ	Max	
OUTPUT VOLTAGE (@ +25°C)	2.48	2.50	2.52	2.498	2.500	2.502	V
OUTPUT VOLTAGE TEMPERATURE DRIFT <sup>1</sup>			100			50	ppm/°C
MINIMUM SUPPLY HEADROOM ( $V_{IN}-V_{OUT}$ ) With $I_{OUT} = 1\text{ mA}$	200			200			mV
LOAD REGULATION 0 mA < $I_{OUT}$ < 5 mA -5 mA < $I_{OUT}$ < 0 mA			200 250			200 250	$\mu\text{V}/\text{mA}$ $\mu\text{V}/\text{mA}$
LOAD REGULATION -100 $\mu\text{A}$ < $I_{OUT}$ < 100 $\mu\text{A}$			2			2	mV/mA
LINE REGULATION $V_{OUT} + 200\text{ mV} < V_{IN} < 12\text{ V}$ $I_{OUT} = 0\text{ mA}$			25			25	$\mu\text{V}/\text{V}$
RIPPLE REJECTION ( $\Delta V_{OUT}/\Delta V_{IN}$ ) $V_{IN} = 5\text{ V} \pm 100\text{ mV}$ ( $f = 120\text{ Hz}$ ) <sup>2</sup>	80			80			dB
QUIESCENT CURRENT			65			65	$\mu\text{A}$
SHORT CIRCUIT CURRENT TO GROUND			15			15	mA
NOISE VOLTAGE (@ +25°C) 0.1 Hz to 10 Hz 10 Hz to 10 kHz		70 50		70 50			$\mu\text{V}$ p-p $\mu\text{V}$ rms
TURN-ON SETTLING TIME TO 0.1% <sup>3</sup>			100			100	$\mu\text{s}$
LONG-TERM STABILITY 1000 Hours @ +25°C <sup>4</sup>		100			100		ppm/1000 hrs.
OUTPUT VOLTAGE HYSTERESIS <sup>5</sup>		115			115		ppm
TEMPERATURE RANGE Specified Performance (A, B) Operating Performance (A, B) <sup>6</sup>	-40 -55		+85 +125	-40 -55		+85 +125	°C °C

### NOTES

<sup>1</sup>Maximum output voltage drift is guaranteed for all grades.

<sup>2</sup>Ripple Rejection over a wide frequency spectrum is shown in Figure 15.

<sup>3</sup>Measured with a capacitance load of 0.2  $\mu\text{F}$ .

<sup>4</sup>Long-term stability at +125°C = 1600 ppm/1000 hours.

<sup>5</sup>Hysteresis is defined as the change in the 25°C output voltage, caused by bringing the device to +85°C, taking a 25°C measurement and then bringing it to -40°C, followed by another 25°C measurement. Refer to Figure 12.

<sup>6</sup>The operating temperature range is defined as the temperature extremes at which the device will still function. Parts may deviate from their specified performance outside the specified temperature range.

Specifications subject to change without notice.

# AD1583—SPECIFICATIONS

(@  $T_A = T_{MIN}-T_{MAX}$ ,  $V_{IN} = 5\text{ V}$ , unless otherwise noted)

Model	AD1583A			AD1583B			Units
	Min	Typ	Max	Min	Typ	Max	
OUTPUT VOLTAGE (@ +25°C)	2.97	3.00	3.03	2.997	3.000	3.003	V
OUTPUT VOLTAGE TEMPERATURE DRIFT <sup>1</sup>			100			50	ppm/°C
MINIMUM SUPPLY HEADROOM ( $V_{IN}-V_{OUT}$ ) With $I_{OUT} = 1\text{ mA}$	200			200			mV
LOAD REGULATION 0 mA < $I_{OUT}$ < 5 mA -5 mA < $I_{OUT}$ < 0 mA			250 400			250 400	$\mu\text{V}/\text{mA}$ $\mu\text{V}/\text{mA}$
LOAD REGULATION -100 $\mu\text{A}$ < $I_{OUT}$ < 100 $\mu\text{A}$			2.4			2.4	mV/mA
LINE REGULATION $V_{OUT} + 200\text{ mV} < V_{IN} < 12\text{ V}$ $I_{OUT} = 0\text{ mA}$			25			25	$\mu\text{V}/\text{V}$
RIPPLE REJECTION ( $\Delta V_{OUT}/\Delta V_{IN}$ ) $V_{IN} = 5\text{ V} \pm 100\text{ mV}$ ( $f = 120\text{ Hz}$ ) <sup>2</sup>	80			80			dB
QUIESCENT CURRENT			65			65	$\mu\text{A}$
SHORT CIRCUIT CURRENT TO GROUND			15			15	mA
NOISE VOLTAGE (@ +25°C) 0.1 Hz to 10 Hz 10 Hz to 10 kHz			85 60			85 60	$\mu\text{V}$ p-p $\mu\text{V}$ rms
TURN-ON SETTTLING TIME TO 0.1% <sup>3</sup>			120			120	$\mu\text{s}$
LONG-TERM STABILITY 1000 Hours @ +25°C			100			100	ppm/1000 hrs.
OUTPUT VOLTAGE HYSTERESIS <sup>4</sup>			115			115	ppm
TEMPERATURE RANGE Specified Performance (A, B) Operating Performance (A, B) <sup>5</sup>	-40 -55		+85 +125	-40 -55		+85 +125	°C °C

## NOTES

<sup>1</sup>Maximum output voltage drift is guaranteed for all grades.

<sup>2</sup>Ripple Rejection over a wide frequency spectrum is shown in Figure 15.

<sup>3</sup>Measured with a capacitance load of 0.2  $\mu\text{F}$ .

<sup>4</sup>Hysteresis is defined as the change in the 25°C output voltage, caused by bringing the device to +85°C, taking a 25°C measurement and then bringing it to -40°C, followed by another 25°C measurement. Refer to Figure 12.

<sup>5</sup>The operating temperature range is defined as the temperature extremes at which the device will still function. Parts may deviate from their specified performance outside the specified temperature range.

Specifications subject to change without notice.

# AD1582/AD1583/AD1584/AD1585

## AD1584—SPECIFICATIONS (@ $T_A = T_{MIN}-T_{MAX}$ , $V_{IN} = 5\text{ V}$ , unless otherwise noted)

Model	AD1584A			AD1584B			Units
	Min	Typ	Max	Min	Typ	Max	
OUTPUT VOLTAGE (@ +25°C)	4.056	4.096	4.136	4.092	4.096	4.100	V
OUTPUT VOLTAGE TEMPERATURE DRIFT <sup>1</sup>			100			50	ppm/°C
MINIMUM SUPPLY HEADROOM ( $V_{IN}-V_{OUT}$ ) With $I_{OUT} = 1\text{ mA}$	200			200			mV
LOAD REGULATION 0 mA < $I_{OUT}$ < 5 mA -5 mA < $I_{OUT}$ < 0 mA			320 320			320 320	$\mu\text{V}/\text{mA}$ $\mu\text{V}/\text{mA}$
LOAD REGULATION -100 $\mu\text{A}$ < $I_{OUT}$ < 100 $\mu\text{A}$			3.2			3.2	mV/mA
LINE REGULATION $V_{OUT} + 200\text{ mV} < V_{IN} < 12\text{ V}$ $I_{OUT} = 0\text{ mA}$			25			25	$\mu\text{V}/\text{V}$
RIPPLE REJECTION ( $\Delta V_{OUT}/\Delta V_{IN}$ ) $V_{IN} = 5\text{ V} \pm 100\text{ mV}$ ( $f = 120\text{ Hz}$ ) <sup>2</sup>	80			80			dB
QUIESCENT CURRENT			65			65	$\mu\text{A}$
SHORT CIRCUIT CURRENT TO GROUND			15			15	mA
NOISE VOLTAGE (@ +25°C) 0.1 Hz to 10 Hz 10 Hz to 10 kHz		110 90		110 90			$\mu\text{V}$ p-p $\mu\text{V}$ rms
TURN-ON SETTLING TIME TO 0.1% <sup>3</sup>			140			140	$\mu\text{s}$
LONG-TERM STABILITY 1000 Hours @ +25°C		100		100			ppm/1000 hrs.
OUTPUT VOLTAGE HYSTERESIS <sup>4</sup>		115		115			ppm
TEMPERATURE RANGE Specified Performance (A, B) Operating Performance (A, B) <sup>5</sup>	-40 -55		+85 +125	-40 -55		+85 +125	°C °C

### NOTES

<sup>1</sup>Maximum output voltage drift is guaranteed for all grades.

<sup>2</sup>Ripple Rejection over a wide frequency spectrum is shown in Figure 15.

<sup>3</sup>Measured with a capacitance load of 0.2  $\mu\text{F}$ .

<sup>4</sup>Hysteresis is defined as the change in the 25°C output voltage, caused by bringing the device to +85°C, taking a 25°C measurement and then bringing it to -40°C, followed by another 25°C measurement. Refer to Figure 12.

<sup>5</sup>The operating temperature range is defined as the temperature extremes at which the device will still function. Parts may deviate from their specified performance outside the specified temperature range.

Specifications subject to change without notice.

# AD1585—SPECIFICATIONS

(@  $T_A = T_{MIN}-T_{MAX}$ ,  $V_{IN} = 6\text{ V}$ , unless otherwise noted)

Model	AD1585A			AD1585B			Units
	Min	Typ	Max	Min	Typ	Max	
OUTPUT VOLTAGE (@ +25°C)	4.95	5.00	5.05	4.995	5.000	5.005	V
OUTPUT VOLTAGE TEMPERATURE DRIFT <sup>1</sup>			100			50	ppm/°C
MINIMUM SUPPLY HEADROOM ( $V_{IN}-V_{OUT}$ ) With $I_{OUT} = 1\text{ mA}$	200			200			mV
LOAD REGULATION $0\text{ mA} < I_{OUT} < 5\text{ mA}$ $-5\text{ mA} < I_{OUT} < 0\text{ mA}$			400 400			400 400	$\mu\text{V}/\text{mA}$ $\mu\text{V}/\text{mA}$
LOAD REGULATION $-100\ \mu\text{A} < I_{OUT} < 100\ \mu\text{A}$			4			4	mV/mA
LINE REGULATION $V_{OUT} + 200\text{ mV} < V_{IN} < 12\text{ V}$ $I_{OUT} = 0\text{ mA}$			25			25	$\mu\text{V}/\text{V}$
RIPPLE REJECTION ( $\Delta V_{OUT}/\Delta V_{IN}$ ) $V_{IN} = 6\text{ V} \pm 100\text{ mV}$ ( $f = 120\text{ Hz}$ ) <sup>2</sup>	80			80			dB
QUIESCENT CURRENT			65			65	$\mu\text{A}$
SHORT CIRCUIT CURRENT TO GROUND			15			15	mA
NOISE VOLTAGE (@ +25°C) 0.1 Hz to 10 Hz 10 Hz to 10 kHz		140 100		140 100			$\mu\text{V p-p}$ $\mu\text{V rms}$
TURN-ON SETTLING TIME TO 0.1% <sup>3</sup>			175			175	$\mu\text{s}$
LONG-TERM STABILITY 1000 Hours @ +25°C		100		100			ppm/1000 hrs.
OUTPUT VOLTAGE HYSTERESIS <sup>4</sup>		115		115			ppm
TEMPERATURE RANGE Specified Performance (A, B) Operating Performance (A, B) <sup>5</sup>	-40 -55		+85 +125	-40 -55		+85 +125	°C °C

## NOTES

<sup>1</sup>Maximum output voltage drift is guaranteed for all grades.

<sup>2</sup>Ripple Rejection over a wide frequency spectrum is shown in Figure 15.

<sup>3</sup>Measured with a capacitance load of 0.2  $\mu\text{F}$ .

<sup>4</sup>Hysteresis is defined as the change in the 25°C output voltage, caused by bringing the device to +85°C, taking a 25°C measurement and then bringing it to -40°C, followed by another 25°C measurement. Refer to Figure 12.

<sup>5</sup>The operating temperature range is defined as the temperature extremes at which the device will still function. Parts may deviate from their specified performance outside the specified temperature range.

Specifications subject to change without notice.

# AD1582/AD1583/AD1584/AD1585

## ABSOLUTE MAXIMUM RATINGS<sup>1</sup>

V <sub>IN</sub> to Ground	12 V
Internal Power Dissipation <sup>2</sup>	
SOT-23 (RT)	400 mW
Storage Temperature Range	-65°C to +125°C
Operating Temperature Range	
AD1582/AD1583/AD1584/AD1585RT	-40°C to +85°C
Lead Temperature, Soldering	
Vapor Phase (60 sec)	+215°C
Infrared (15 sec)	+220°C

## NOTES

<sup>1</sup>Stresses above those listed under Absolute Maximum Ratings may cause permanent damage to the device. This is a stress rating only; functional operation of the device at these or any other conditions above those indicated in the operational section of this specification is not implied. Exposure to absolute maximum rating conditions for extended periods may affect device reliability.

<sup>2</sup>Specification is for device in free air at 25°C: SOT-23 Package:  $\theta_{JA} = 300^{\circ}\text{C}/\text{W}$ .

## PACKAGE BRANDING INFORMATION

Four marking fields identify the device generic, grade and date of processing. The first field is the product identifier. A “2/3/4/5” identifies the generic as the AD1582/3/4/5. The second field indicates the device grade; “A” or “B.” In the third field a numeral or letter indicates the calendar year; “7” for 1997. . . , “A” for 2001. . . The fourth field uses letters A-Z to represent a two week window within the calendar year, starting with “A” for the first two weeks of January.

## ORDERING GUIDE

Model <sup>1</sup>	Initial Output Error	Temperature Coefficient
AD1582/AD1583/AD1584/AD1585ART	1.0%	100 ppm/°C
AD1582/AD1583/AD1584/AD1585ARTRL <sup>2</sup>	1.0%	100 ppm/°C
AD1582/AD1583/AD1584/AD1585ARTRL7 <sup>3</sup>	1.0%	100 ppm/°C
AD1582/AD1583/AD1584/AD1585BRT	0.1%	50 ppm/°C
AD1582/AD1583/AD1584/AD1585BRTRL <sup>2</sup>	0.1%	50 ppm/°C
AD1582/AD1583/AD1584/AD1585BRTRL7 <sup>3</sup>	0.1%	50 ppm/°C

## NOTES

<sup>1</sup>Package Option for all Models; RT = Surface Mount, SOT-23.

<sup>2</sup>Provided on a 13-inch reel containing 10,000 pieces.

<sup>3</sup>Provided on a 7-inch reel containing 3,000 pieces.

## CAUTION

ESD (electrostatic discharge) sensitive device. Electrostatic charges as high as 4000 V readily accumulate on the human body and test equipment and can discharge without detection. Although the AD1582/AD1583/AD1584/AD1585 feature proprietary ESD protection circuitry, permanent damage may occur on devices subjected to high energy electrostatic discharges. Therefore, proper ESD precautions are recommended to avoid performance degradation or loss of functionality.

# Typical Performance Characteristics—AD1582/AD1583/AD1584/AD1585

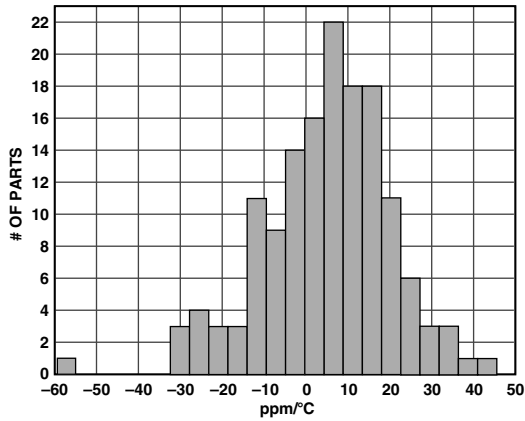

Figure 2. Typical Output Voltage Temperature Drift Distribution

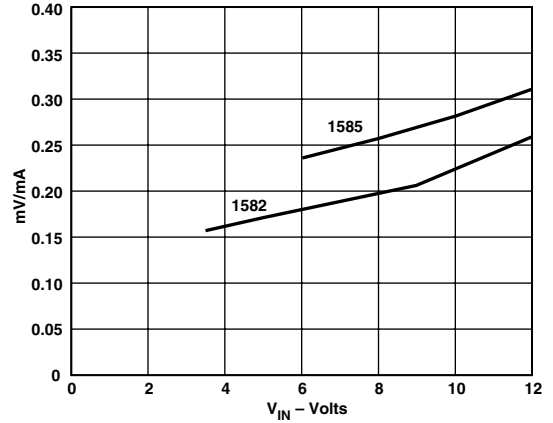

Figure 5. Load Regulation vs.  $V_{IN}$

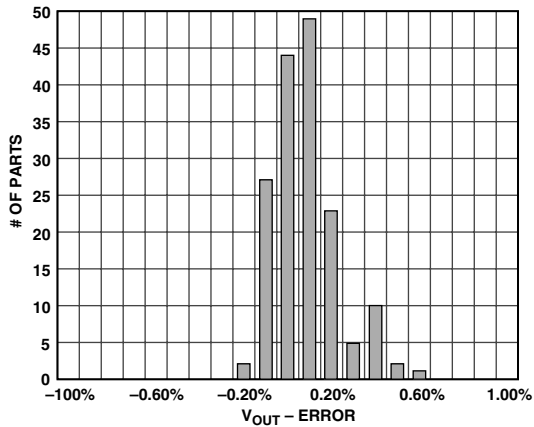

Figure 3. Typical Output Voltage Error Distribution

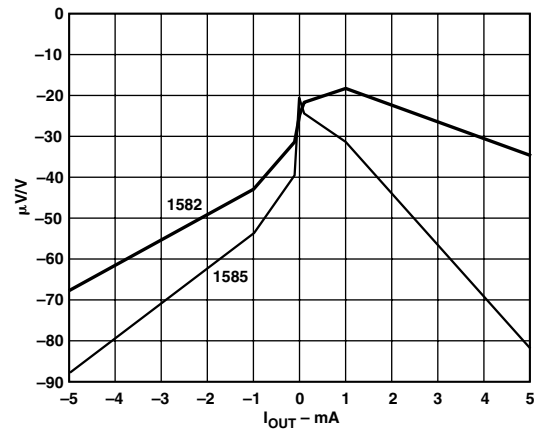

Figure 6. Line Regulation vs.  $I_{LOAD}$

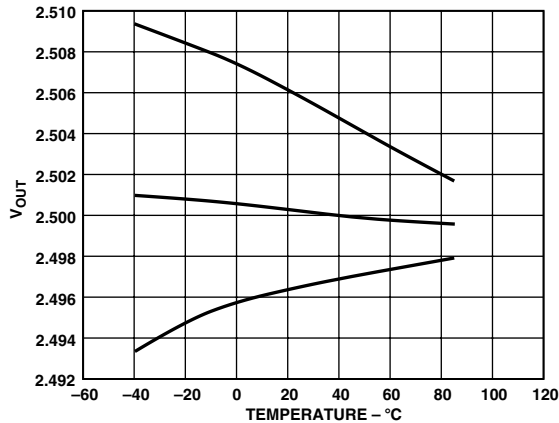

Figure 4. Typical Temperature Drift Characteristic Curves

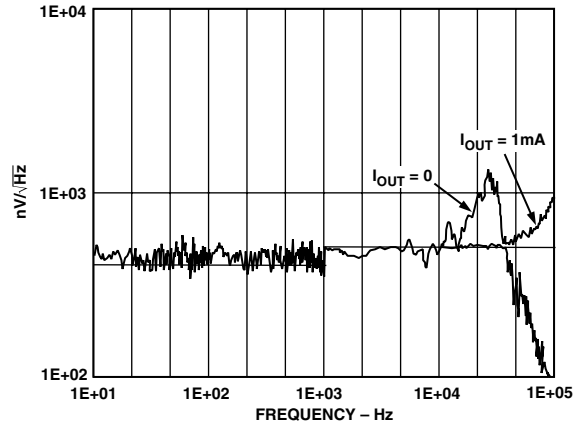

Figure 7. Noise Spectral Density

# AD1582/AD1583/AD1584/AD1585

## THEORY OF OPERATION

The AD1582/AD1583/AD1584/AD1585 family uses the “bandgap” concept to produce stable, low temperature coefficient voltage references suitable for high accuracy data acquisition components and systems. This family of precision references makes use of the underlying temperature characteristics of a silicon transistor’s base-emitter voltage in the forward biased operating region. Under this condition, all such transistors have a  $-2 \text{ mV}/^\circ\text{C}$  temperature coefficient (TC) and a  $V_{BE}$  that, when extrapolated to absolute zero,  $0^\circ\text{K}$ , (with collector current proportional to absolute temperature) approximates the silicon bandgap voltage. By summing a voltage that has an equal and opposite temperature coefficient of  $+2 \text{ mV}/^\circ\text{C}$  with the  $V_{BE}$  of a forward-biased transistor, a zero TC reference can be developed. In the AD1582/AD1583/AD1584/AD1585 simplified circuit diagram shown in Figure 8, such a compensating voltage,  $V_1$ , is derived by driving two transistors at different current densities and amplifying the resultant  $V_{BE}$  difference ( $\Delta V_{BE}$ —which has a positive TC). The sum ( $V_{BG}$ ) of  $V_{BE}$  and  $V_1$  is then buffered and amplified to produce stable reference voltage outputs of 2.5 V, 3 V, 4.096 V, and 5 V.

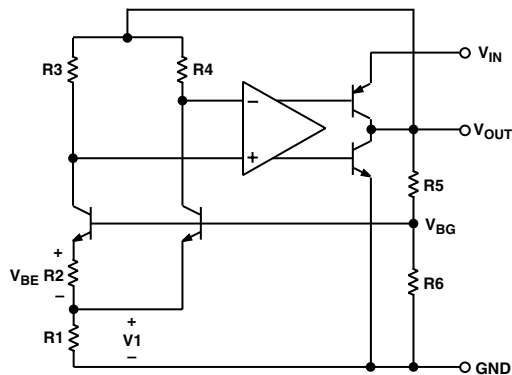

Figure 8. Simplified Schematic

## APPLYING THE AD1582/AD1583/AD1584/AD1585

The AD1582/AD1583/AD1584/AD1585 is a family of series references that can be utilized for many applications. To achieve optimum performance with these references, only two external components are required. Figure 9 shows the AD1582 configured for operation under all loading conditions. With a simple  $4.7 \mu\text{F}$  capacitor attached to the input and a  $1 \mu\text{F}$  capacitor applied to the output, the devices will achieve specified performance for all input voltage and output current requirements. For best transient response, add a  $0.1 \mu\text{F}$  capacitor in parallel with the  $4.7 \mu\text{F}$ . While a  $1 \mu\text{F}$  output capacitor will provide stable performance for all loading conditions, the AD1582 can operate under low ( $-100 \mu\text{A} < I_{OUT} < 100 \mu\text{A}$ ) current conditions with just a  $0.2 \mu\text{F}$  output capacitor. The  $4.7 \mu\text{F}$  capacitor on the input can be reduced to  $1 \mu\text{F}$  in this condition.

Unlike conventional shunt reference designs, the AD1582/AD1583/AD1584/AD1585 family provides stable output voltages at constant operating current levels. When properly decoupled, as shown in Figure 9, these devices can be applied to any circuit and provide superior low power solutions.

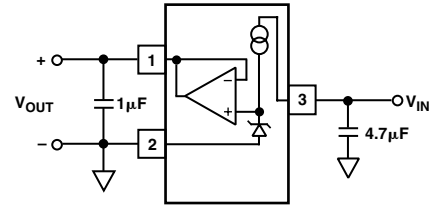

Figure 9. Typical Connection Diagram

## TEMPERATURE PERFORMANCE

The AD1582/AD1583/AD1584/AD1585 family of references is designed for applications where temperature performance is important. Extensive temperature testing and characterization ensures that the device’s performance is maintained over the specified temperature range.

Some confusion exists, however, in the area of defining and specifying reference voltage error over temperature. Historically, references have been characterized using a maximum deviation per degree centigrade, i.e.,  $50 \text{ ppm}/^\circ\text{C}$ . However, because of the inconsistent nonlinearities in standard zener references (such as “S” type characteristics), most manufacturers use a maximum limit error band approach to characterize their references. Using this technique, the voltage reference output voltage error band is specified by taking output voltage measurements at three or more different temperatures.

The error band guaranteed with the AD1582/AD1583/AD1584/AD1585 family is the maximum deviation from the initial value at  $+25^\circ\text{C}$ ; this method is of more use to a designer than the one which simply guarantees the maximum error band over the entire temperature change. Thus, for a given grade of the AD1582/AD1583/AD1584/AD1585, the designer can easily determine the maximum total error by summing initial accuracy and temperature variation (e.g., for the AD1582BRT, the initial tolerance is  $\pm 2 \text{ mV}$ , the temperature error band is  $\pm 8 \text{ mV}$ , thus the reference is guaranteed to be  $2.5 \text{ V} \pm 10 \text{ mV}$  from  $-40^\circ\text{C}$  to  $+85^\circ\text{C}$ ).

Figure 10 shows the typical output voltage drift for the AD1582 and illustrates the methodology. The box in Figure 10 is bounded on the x-axis by operating temperature extremes, and on the y-axis by the maximum and minimum output voltages observed over the operating temperature range. The slope of the diagonal drawn from the initial output value at  $+25^\circ\text{C}$  to the output values at  $+85^\circ\text{C}$  and  $-40^\circ\text{C}$  determines the performance grade of the device.

Duplication of these results requires a test system that is highly accurate with stable temperature control. Evaluation of the AD1582 will produce curves similar to those in Figures 4 and 10, but output readings may vary depending upon the test methods and test equipment utilized.



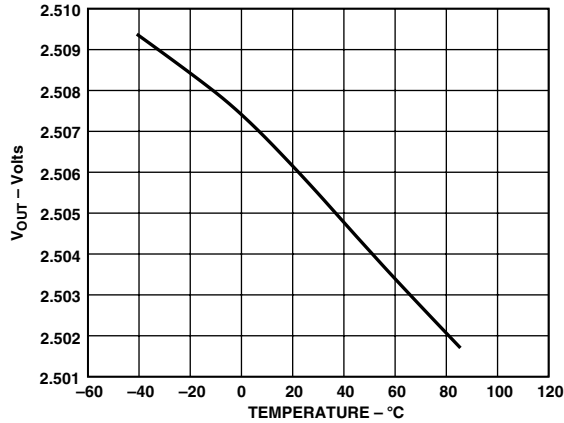

Figure 10. Output Voltage vs. Temperature

### VOLTAGE OUTPUT NONLINEARITY VS. TEMPERATURE

When using a voltage reference with data converters, it is important to understand the impact that temperature drift can have on the converter's performance. The nonlinearity of the reference output drift represents additional error that cannot easily be calibrated out of the overall system. To better understand the impact such a drift can have on a data converter, refer to Figure 11 where the measured drift characteristic is normalized to the end point average drift. The residual drift error of the AD1582 of approximately 200 ppm demonstrates that this family of references is compatible with systems that require 12-bit accurate temperature performance.

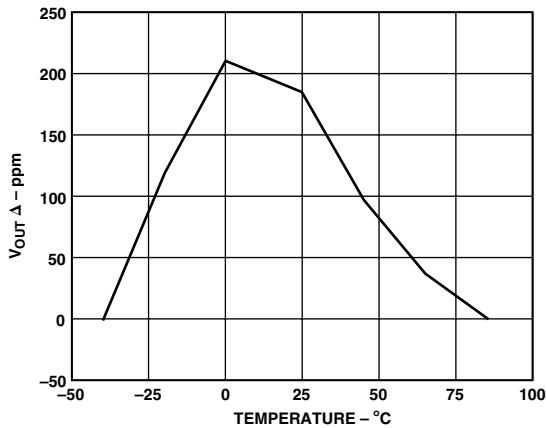

Figure 11. Residual Drift Error

### OUTPUT VOLTAGE HYSTERESIS

High performance industrial equipment manufacturers may require the AD1582/AD1583/AD1584/AD1585 family to maintain a consistent output voltage error at +25°C after the references are operated over the full temperature range. While all references exhibit a characteristic known as output voltage

hysteresis, the AD1582/AD1583/AD1584/AD1585 family is designed to minimize this characteristic. This phenomenon can be quantified by measuring the change in the +25°C output voltage after temperature excursions from +85°C to +25°C, and -40°C to +25°C. Figure 12 displays the distribution of the AD1582 output voltage hysteresis.

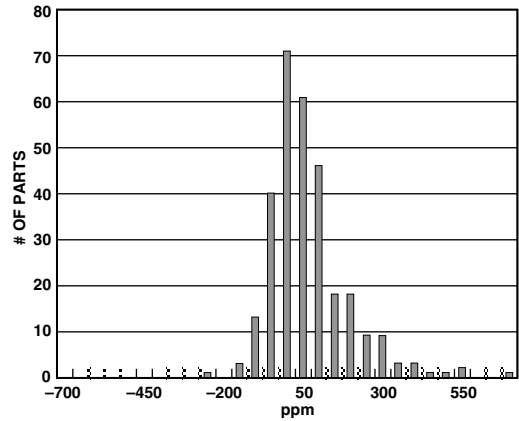

Figure 12. Output Voltage Hysteresis Distribution

### SUPPLY CURRENT VS. TEMPERATURE

The quiescent current for the AD1582/AD1583/AD1584/AD1585 family of references will vary slightly over temperature and input supply range. Figure 13 demonstrates the typical performance for the AD1582 reference when varying both temperature and supply voltage. As is evident from the graph, the AD1582 supply current increases only 1.0  $\mu\text{A}/\text{V}$ , making this device extremely attractive for use in applications where there may be wide variations in supply voltage and a need to minimize power dissipation.

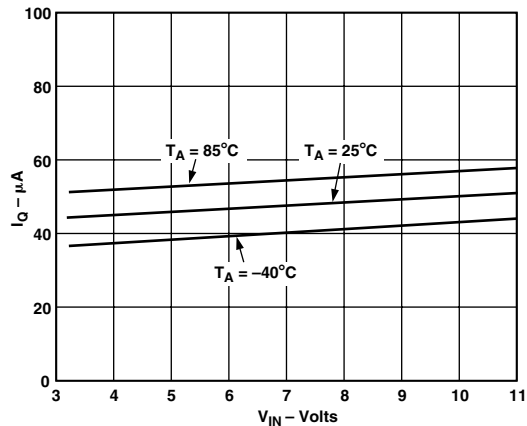

Figure 13. Typical Supply Current over Temperature

# AD1582/AD1583/AD1584/AD1585

## AC PERFORMANCE

To successfully apply the AD1582/AD1583/AD1584/AD1585 family of references, it is important to understand the effects of dynamic output impedance and power supply rejection. In Figure 14a, a voltage divider is formed by the AD1582's output impedance and the external source impedance. Figure 14b shows the effect of varying the load capacitor on the reference output. Power supply rejection ratio (PSRR) should be determined when characterizing the ac performance of a series voltage reference. Figure 15a shows a test circuit used to measure PSRR, and Figure 15b demonstrates the AD1582's ability to attenuate line voltage ripple.

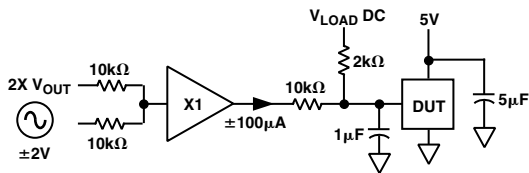

Figure 14a. Output Impedance Test Circuit

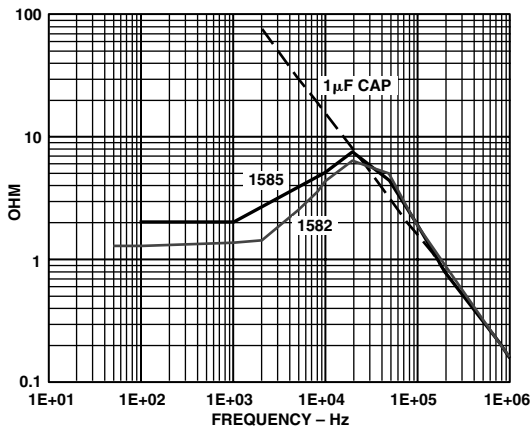

Figure 14b. Output Impedance vs. Frequency

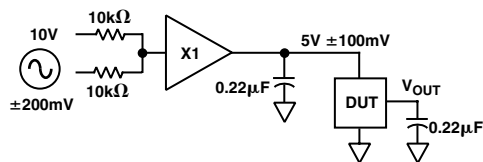

Figure 15a. Ripple Rejection Test Circuit

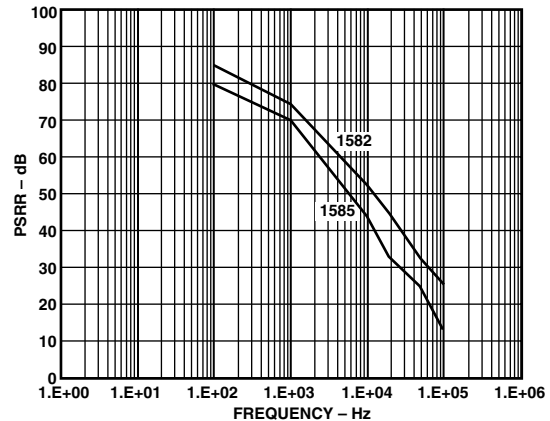

Figure 15b. Ripple Rejection vs. Frequency

## NOISE PERFORMANCE AND REDUCTION

The noise generated by the AD1582 is typically less than  $70 \mu\text{V}$  p-p over the 0.1 Hz to 10 Hz frequency band. Figure 16 shows the 0.1 Hz to 10 Hz noise of a typical AD1582. The noise measurement is made with a high gain bandpass filter. Noise in a 10 Hz to 10 kHz region is approximately  $50 \mu\text{V}$  rms. Figure 17 shows the broadband noise of a typical AD1582. If further noise reduction is desired, a 1-pole low-pass filter may be added between the output pin and ground. A time constant of 0.2 ms will have a  $-3 \text{ dB}$  point at roughly 800 Hz, and will reduce the high frequency noise to about  $16 \mu\text{V}$  rms. It should be noted, however, that while additional filtering on the output may improve the noise performance of the AD1582/AD1583/AD1584/AD1585 family, the added output impedance could degrade the ac performance of the references.

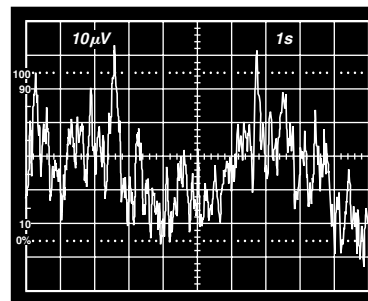

Figure 16. 0.1–10 Hz Voltage Noise

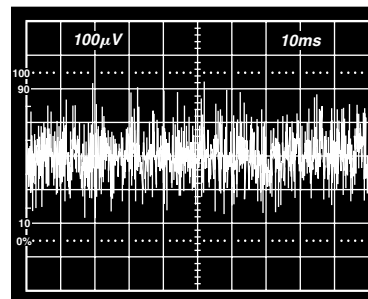

Figure 17. 10 Hz to 10 kHz Wideband Noise

## TURN-ON TIME

Many low power instrument manufacturers are becoming increasingly concerned with the turn-on characteristics of the components being used in their systems. Fast turn-on components often enable the end user to save power by keeping power off when it is not needed. Turn-on settling time is defined as the time required, after the application of power (cold start), for the output voltage to reach its final value within a specified error. The two major factors affecting this are the active circuit settling time and the time required for the thermal gradients on the chip to stabilize. Figure 18a shows the turn-on settling and transient response test circuit. Figure 18b displays the turn-on characteristic of the AD1582. This characteristic is generated from cold-start operation and represents the true turn-on waveform after power up. Figure 18c shows the fine settling characteristics of the AD1582. Typically, the reference settles to within 0.1% of its final value in about 100  $\mu$ s.

The device can momentarily draw excessive supply current when  $V_{SUPPLY}$  is slightly below the minimum specified level. Power supply resistance must be low enough to ensure reliable turn-on. Fast power supply edges minimize this effect.

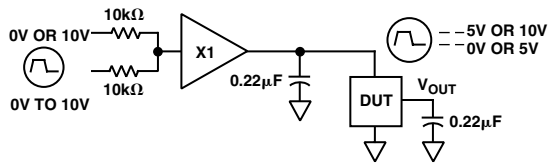

Figure 18a. Turn-On/Transient Response Test Circuit

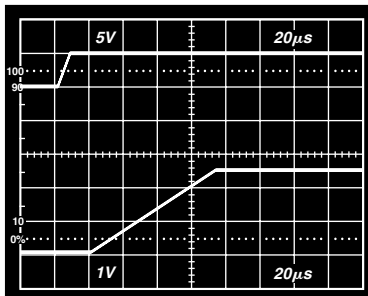

Figure 18b. Turn-On Characteristics

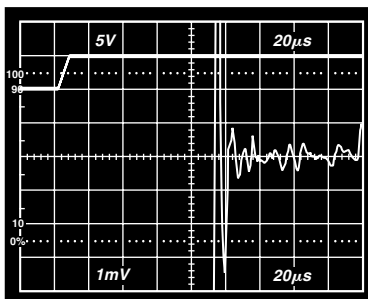

Figure 18c. Turn-On Settling

## DYNAMIC PERFORMANCE

Many A/D and D/A converters present transient current loads to the reference, and poor reference response can degrade the converter's performance. The AD1582/3/4/5 family of references has been designed to provide superior static and dynamic line and load regulation. Since these series references are capable of both sourcing and sinking large current loads, they exhibit excellent settling characteristics.

Figure 19 displays the line transient response for the AD1582. The circuit utilized to perform such a measurement is displayed in Figure 18a, where the input supply voltage is toggled from 5 V to 10 V and the input and output capacitors are each 0.22  $\mu$ F.

Figures 20 and 21 show the load transient settling characteristics for the AD1582 when load current steps of 0 mA to 5 mA and 0 mA to -1 mA are applied. The input supply voltage remains constant at 5 V, the input decoupling and output load capacitors are 4.7  $\mu$ F and 1  $\mu$ F respectively, and the output current is toggled. For both positive and negative current loads, the reference responses settle very quickly and exhibit initial voltage spikes less than 10 mV.

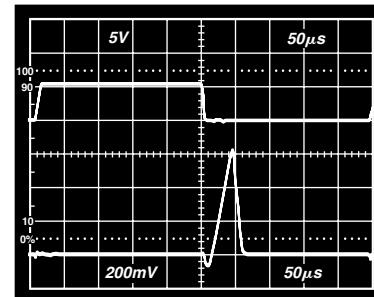

Figure 19. Line Transient Response

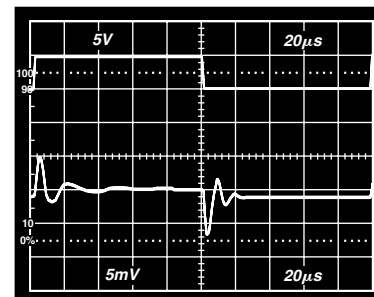

Figure 20. Load Transient Response (0 mA to 5 mA Load)

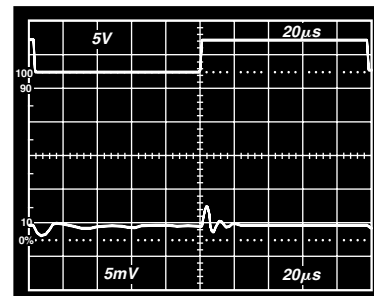

Figure 21. Load Transient Response (0 mA to -1 mA Load)

# AD1582/AD1583/AD1584/AD1585

## OUTLINE DIMENSIONS

Dimensions shown in inches and (mm).

### Surface Mount Package SOT-23

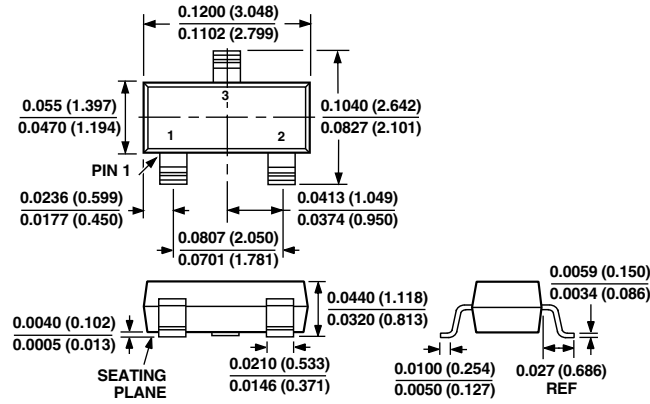

## TAPE AND REEL DIMENSIONS

Dimensions shown in millimeters.

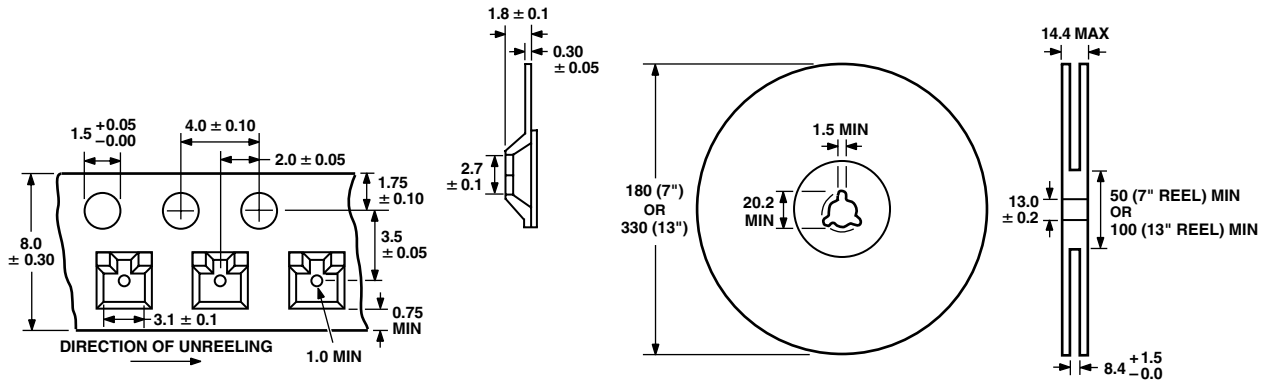

C29716-0-3/00 (rev. A)

PRINTED IN U.S.A.