

TOSHIBA BIPOLAR LINEAR INTEGRATED CIRCUIT SILICON MONOLITHIC

TA76431AS

ADJUSTABLE PRECISION SHUNT REGULATOR

FEATURES

- Precision Reference Voltage : $V_{REF} = 2.495\text{ V} \pm 1\%$
- Small Temperature Coefficient : $|\alpha V_{REF}| = 46\text{ ppm}/^\circ\text{C}$
- Adjustable Output Voltage : $V_{REF} \leq V_{OUT} \leq 36\text{ V}$
- Low Dynamic Output Impedance : $|Z_{KA}| = 0.15\ \Omega$ (Typ.)

FUNCTIONAL BLOCK DIAGRAM

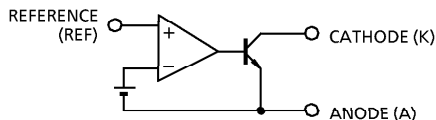

CIRCUIT SYMBOL

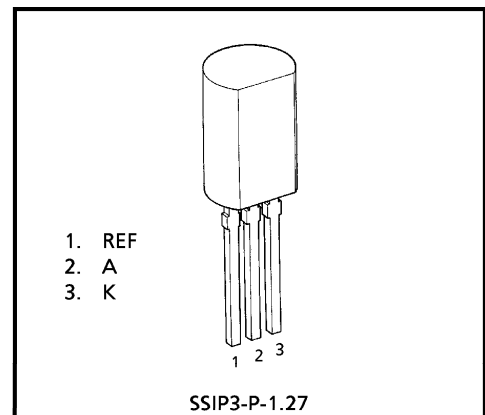
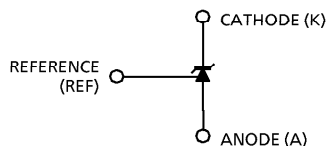

Weight : 0.36 g (Typ.)

THIS IC CONTAINS ELECTROSTATIC SENSITIVE ELEMENT.
PLEASE HANDLE WITH CAUTION.

EQUIVALENT CIRCUIT

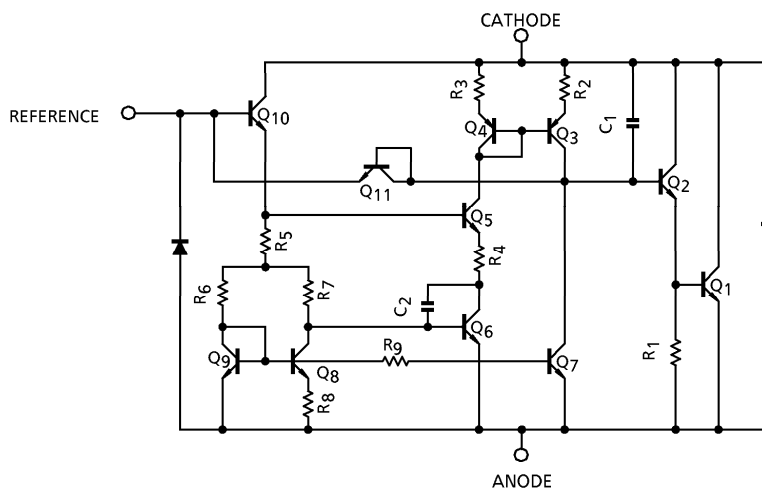

980910EBA1

- TOSHIBA is continually working to improve the quality and the reliability of its products. Nevertheless, semiconductor devices in general can malfunction or fail due to their inherent electrical sensitivity and vulnerability to physical stress. It is the responsibility of the buyer, when utilizing TOSHIBA products, to observe standards of safety, and to avoid situations in which a malfunction or failure of a TOSHIBA product could cause loss of human life, bodily injury or damage to property. In developing your designs, please ensure that TOSHIBA products are used within specified operating ranges as set forth in the most recent products specifications. Also, please keep in mind the precautions and conditions set forth in the TOSHIBA Semiconductor Reliability Handbook.
- The products described in this document are subject to the foreign exchange and foreign trade laws.
- The information contained herein is presented only as a guide for the applications of our products. No responsibility is assumed by TOSHIBA CORPORATION for any infringements of intellectual property or other rights of the third parties which may result from its use. No license is granted by implication or otherwise under any intellectual property or other rights of TOSHIBA CORPORATION or others.
- The information contained herein is subject to change without notice.

MAXIMUM RATINGS ($T_a = 25^\circ\text{C}$)

CHARACTERISTIC	SYMBOL	RATING	UNIT
Cathode Voltage	V_{KA}	37	V
Cathode Current	I_K	- 100~150	mA
Reference Voltage	V_{REF}	7	V
Reference Current	I_{REF}	50	μA
Reference-Anode Reverse Current	$-I_{REF}$	10	mA
Power Dissipation $T_a = 25^\circ\text{C}$	P_D	800	mW
Operating Temperature	T_{opr}	- 40~85	$^\circ\text{C}$
Storage Temperature	T_{stg}	- 55~150	$^\circ\text{C}$

RECOMMENDED OPERATING CONDITIONS

CHARACTERISTIC	SYMBOL	MIN.	TYP.	MAX.	UNIT
Cathode Voltage	V_{KA}	V_{REF}	—	36	V
Cathode Current	I_K	1	—	100	mA
Operating Temperature	T_{opr}	- 40	—	85	$^\circ\text{C}$

ELECTRICAL CHARACTERISTICS (Unless otherwise specified, $T_a = 25^\circ\text{C}$, $I_K = 10\text{ mA}$)

CHARACTERISTIC	SYMBOL	TEST CIR-CUIT	TEST CONDITION	MIN.	TYP.	MAX.	UNIT
Reference Voltage	V_{REF}	—	$V_{KA} = V_{REF}$	2.470	2.495	2.520	V
Deviation of Reference Input Voltage Over Temperature	$V_{REF}(\text{dev})$ (Note)	—	$0^\circ\text{C} \leq T_a \leq 70^\circ\text{C}$ $V_{KA} = V_{REF}$	—	8	17	mV
Ratio of Change in Reference Input Voltage to the Change in Cathode Voltage	$\Delta V_{REF} / \Delta V$	—	$V_{REF} \leq V_{KA} \leq 10\text{ V}$	—	0.8	2.7	mV/V
		—	$10\text{ V} \leq V_{KA} \leq 36\text{ V}$	—	0.5	2.0	
Reference Input Current	I_{REF}	—	$V_{KA} = V_{REF}$	—	1.4	4	μA
Deviation of Reference Input Current Over Temperature	$I_{REF}(\text{dev})$ (Note)	—	$0^\circ\text{C} \leq T_a \leq 70^\circ\text{C}$, $V_{KA} = V_{REF}$ $R_1 = 10\text{ k}\Omega$, $R_2 = \infty$	—	0.3	1.2	μA
Minimum Cathode Current for Regulation	I_{Kmin}	—	$V_{KA} = V_{REF}$	—	0.4	1.0	mA
Off-State Cathode Current	I_{Koff}	—	$V_{KA} = 36\text{ V}$, $V_{REF} = 0\text{ V}$	—	—	1.0	μA
Dynamic Impedance	$ Z_{KA} $	—	$V_{KA} = V_{REF}$, $f \leq 1\text{ kHz}$ $1\text{ mA} \leq I_K \leq 100\text{ mA}$	—	0.15	0.5	Ω

Note : The deviation parameters $V_{REF}(\text{dev})$ and $I_{REF}(\text{dev})$ are defined as the maximum variation of the V_{REF} and I_{REF} over the rated temperature range.
The average temperature coefficient of the V_{REF} is defined as ;

$$|\alpha V_{REF}| = \frac{\frac{V_{REF}(\text{dev})}{V_{REF@25^\circ\text{C}}} \times 10^6}{\Delta T_a} \text{ (ppm / } ^\circ\text{C)}$$

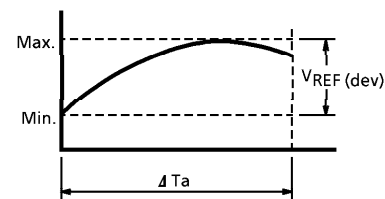

TEST PARAMETER

(1) $V_{KA} = V_{REF}$ MODE

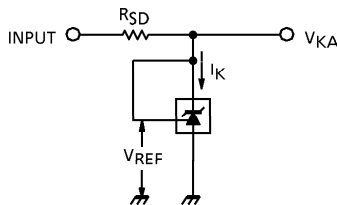

(2) $V_{KA} > V_{REF}$ MODE

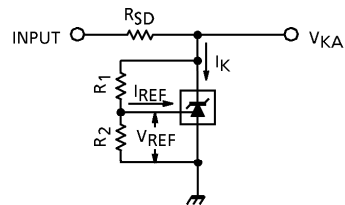

$$V_{KA} = V_{REF} \left(1 + \frac{R_1}{R_2} \right) + I_{REF} \cdot R_1$$

(3) OFF-STATE MODE

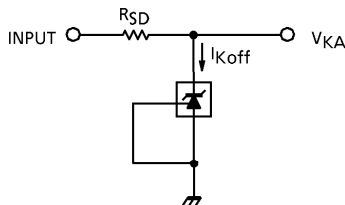

TYPICAL APPLICATIONS

(1) 2.5 V REFERENCE

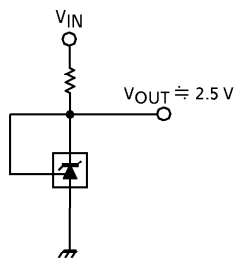

(2) SHUNT REGULATOR

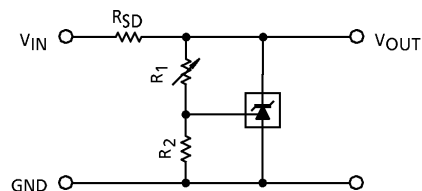

$$V_{OUT} = V_{REF} \left(1 + \frac{R_1}{R_2} \right) + I_{REF} \cdot R_1$$

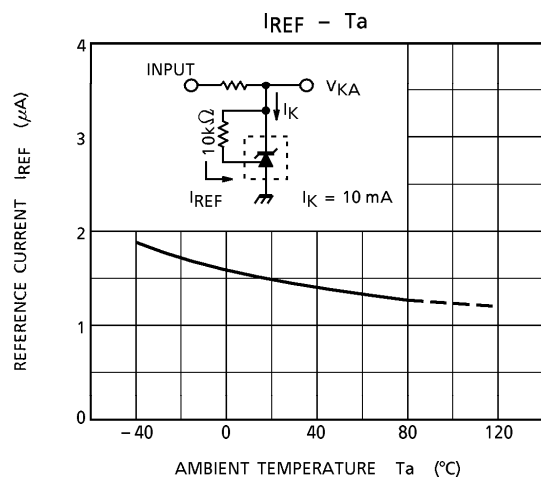
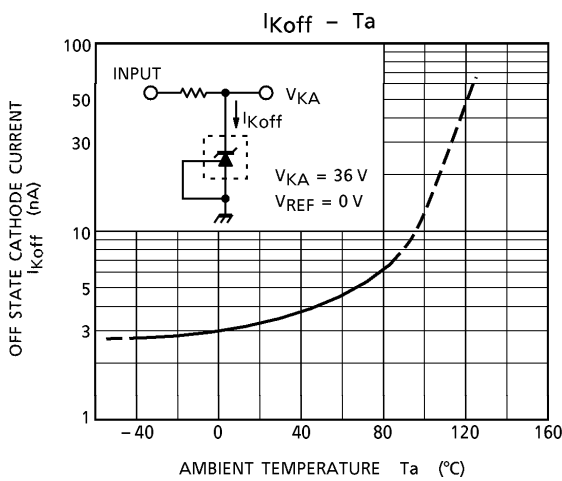
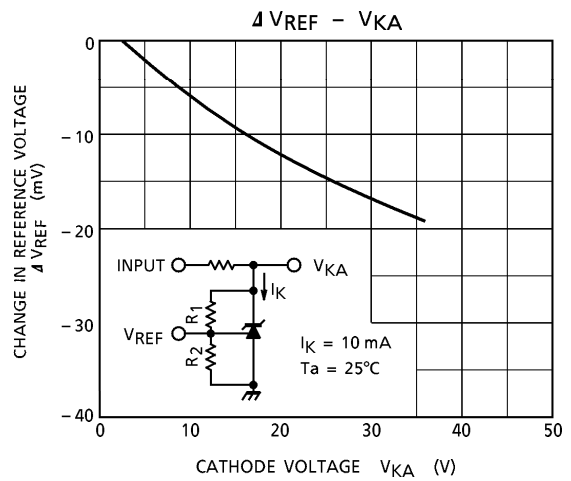
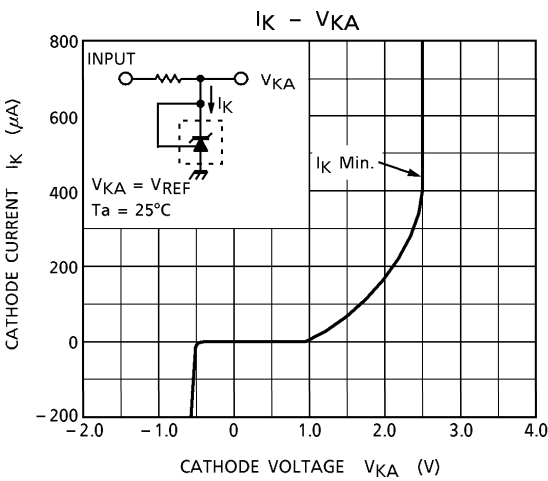
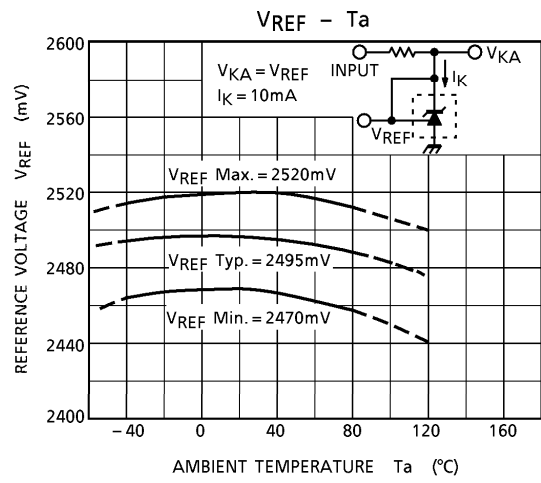
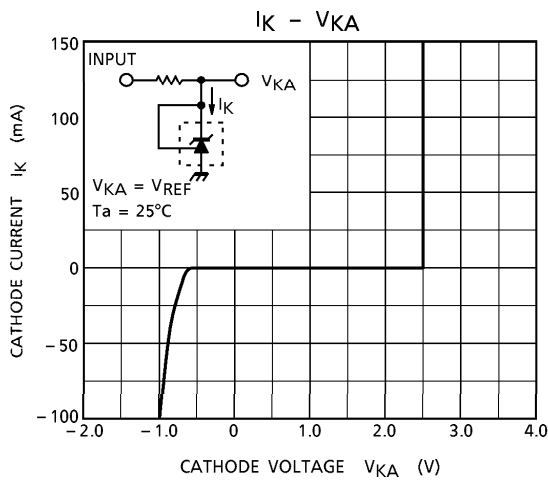

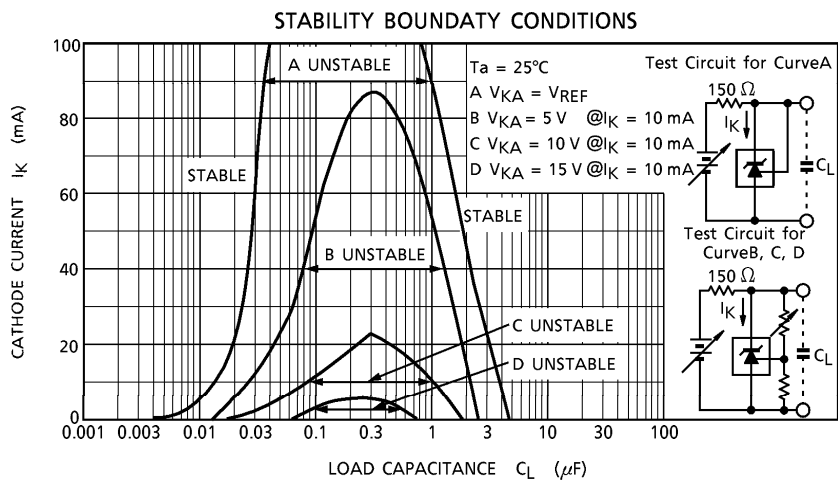
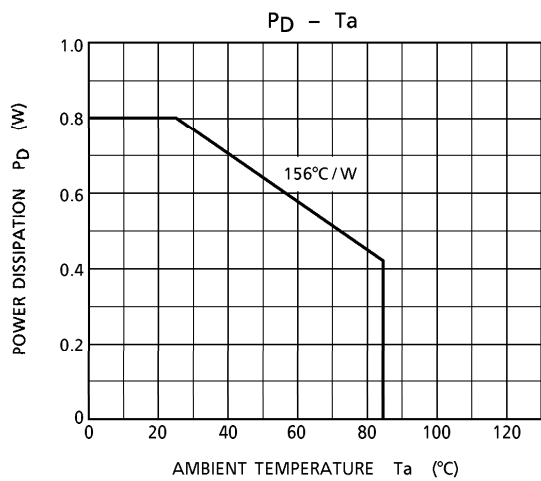
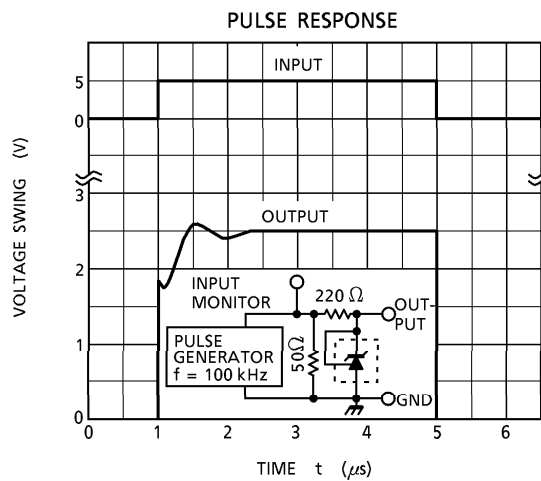
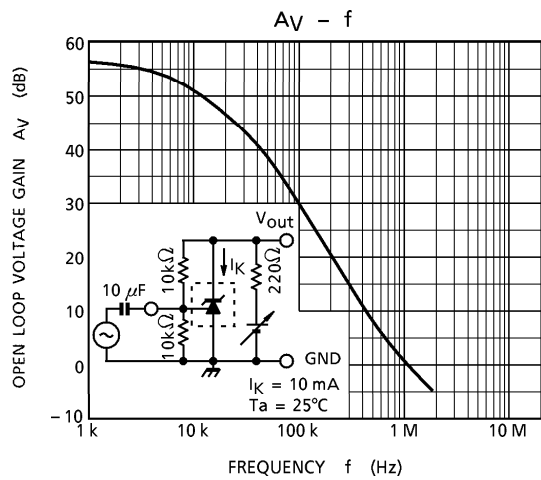
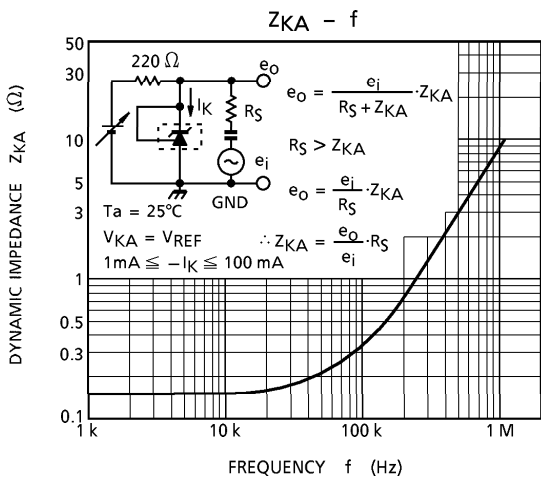

OUTLINE DRAWING
SSIP3-P-1.27

Unit : mm

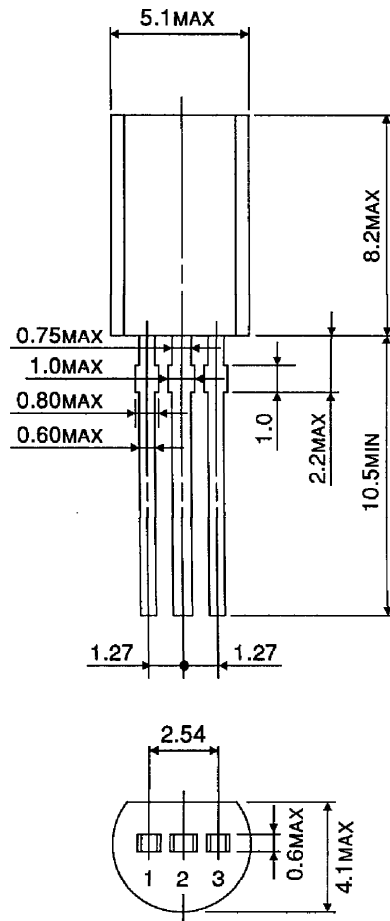

Weight : 0.36 g (Typ.)