HA178L00 Series

3-terminal Fixed Voltage Regulators

HITACHI

Description

The HA178L00 series three-terminal fixed output voltage regulators. Can be used not only as stabilized power sources, but also as Zener diodes because of their small outline package.

Features

- Maximum output current: 150 mA ($T_j = 25^\circ\text{C}$)
- Large maximum power dissipation: 800 mW
- Overcurrent protection
- Temperature protection circuit

Ordering Information

Application	Standard Output Voltage Tolerance $\pm 8\%$	A Version Output Voltage Tolerance $\pm 5\%$
Industrial use	HA178L00P	HA178L00PA
Commercial use	HA178L00	HA178L00A HA178L00UA

HA178L00 Series

Output Voltage and Type

HA178L00PA • HA178L00P • HA178L00A • HA178L00

Output Voltage (V)	Type	Package
2.5	HA178L02	TO-92M
5	HA178L05	
5.6	HA178L56	
6	HA178L06	
8	HA178L08	
9	HA178L09	
10	HA178L10	
12	HA178L12	
15	HA178L15	

HA178L00UA

Output Voltage (V)	Type	Marking	Package
2.5	HA178L02UA	8A	UPAK
5	HA178L05UA	8B	
5.6	HA178L56UA	8C	
6	HA178L06UA	8D	
8	HA178L08UA	8E	
9	HA178L09UA	8F	
10	HA178L10UA	8G	
12	HA178L12UA	8H	
15	HA178L15UA	8J	

Pin Arrangement

• TO-92M

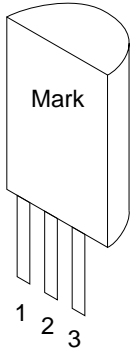

- 1. OUT
- 2. GND
- 3. IN

• UPAK

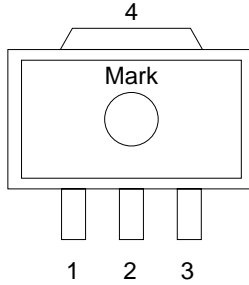

- 1. OUT
- 2. GND
- 3. IN
- 4. GND

Block Diagram

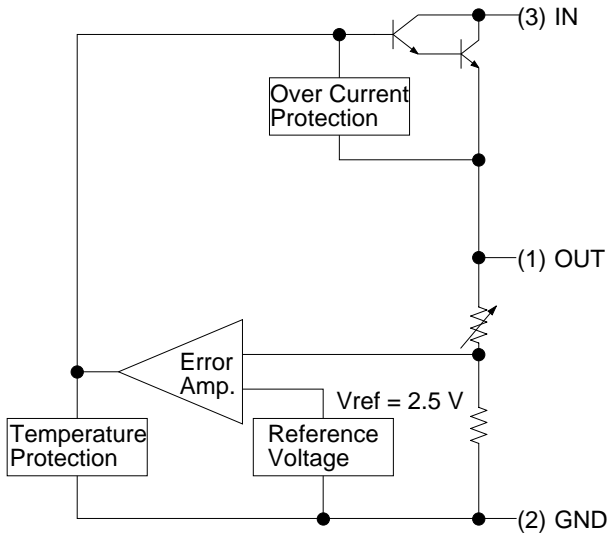

Standard Circuit

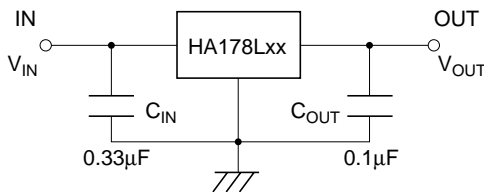

HITACHI

UPAK Product (HA178L00UA) Mark Patterns

The mark patterns shown below are used, on UPAK products, as the package is small. Note that the product code and mark pattern are different. The pattern is laser-printed.

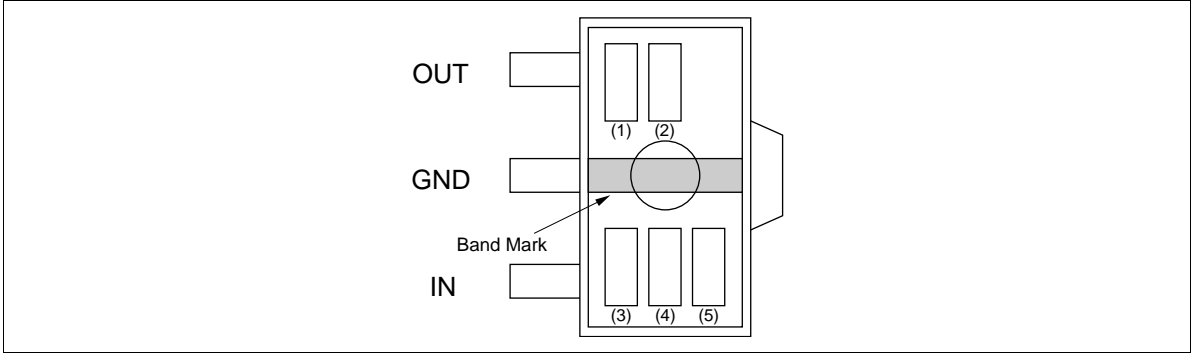

- Notes:
1. Boxes (1) to (5) in the figures show the position of the letters or numerals, and are not actually marked on the package.
 2. (1) and (2) show the product-specific mark pattern. (see table 1)

Table 1

Output Voltage (V)	Product No.	Mark Pattern (2 digit)
2.5	HA178L02UA	8A
5	HA178L05UA	8B
5.6	HA178L56UA	8C
6	HA178L06UA	8D
8	HA178L08UA	8E
9	HA178L09UA	8F
10	HA178L10UA	8G
12	HA178L12UA	8H
15	HA178L15UA	8J

3. (3) shows the production year code (the last digit of the year).
4. (4) shows the production month code (see table 2).

Table 2

Production Month	1	2	3	4	5	6	7	8	9	10	11	12
Marked Code	A	B	C	D	E	F	G	H	J	K	L	M

5. (5) shows the production week code.

Absolute Maximum Ratings (Ta = 25°C)

Item	Symbol	Rating	Unit	Note
Input voltage	V_{IN}	35	V	
Power dissipation	P_T	800	mW	TO-92M* ¹
		800	mW	UPAK* ²
Operating ambient temperature	Topr	-20 to +75	°C	TO-92M
		-20 to +85	°C	UPAK
Storage temperature	Tstg	-55 to +150	°C	

- Note: 1. $T_a \leq 25^\circ\text{C}$, If $T_a > 25^\circ\text{C}$, derate by $6.4 \text{ mW}/^\circ\text{C}$ (See figure A)
 2. $15\text{mm} \times 25\text{mm} \times 0.7 \text{ mm}$ alumina ceramic board, $T_a \leq 25^\circ\text{C}$ (See figure B)

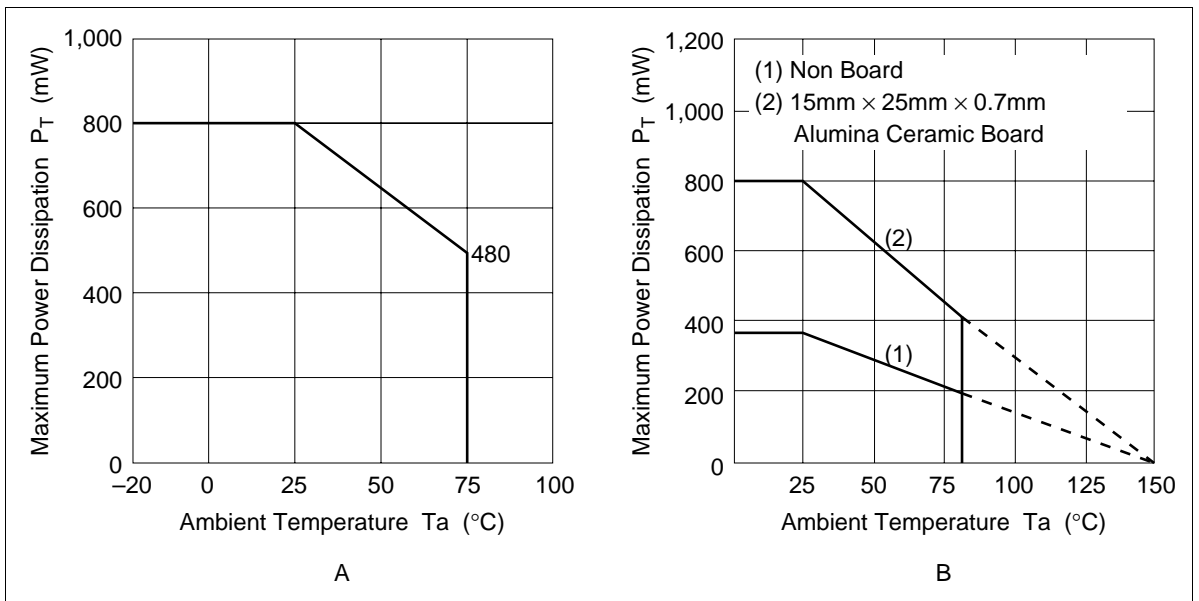

HA178L00 Series

HA178L02 Electrical Characteristics

($V_{IN} = 10\text{ V}$, $I_{OUT} = 40\text{ mA}$, $0^\circ\text{C} \leq T_j \leq 125^\circ\text{C}$, $C_{IN} = 0.33\ \mu\text{F}$, $C_{OUT} = 0.1\ \mu\text{F}$)

Item	Symbol	HA178L02P HA178L02			HA178L02PA HA178L02A HA178L02UA			Unit	Test Conditions
		Min	Typ	Max	Min	Typ	Max		
Output voltage	V_{OUT}	2.32	2.48	2.64	2.38	2.48	2.58	V	$T_j = 25^\circ\text{C}$
Line regulation	δV_{OLINE}	—	35	125	—	35	95	mV	$T_j = 25^\circ\text{C}$ $7\text{ V} \leq V_{IN} \leq 20\text{ V}$ $8\text{ V} \leq V_{IN} \leq 20\text{ V}$
		—	30	100	—	30	75		
Load regulation	δV_{OLOAD}	—	14	—	—	14	—	mV	$T_j = 25^\circ\text{C}$ $1.0\text{ mA} \leq I_{OUT} \leq 150\text{ mA}$ $1.0\text{ mA} \leq I_{OUT} \leq 100\text{ mA}$ $1.0\text{ mA} \leq I_{OUT} \leq 40\text{ mA}$
		—	9.5	50	—	9.5	50		
		—	4.5	25	—	4.5	25		
Output voltage	V_{OUT}	2.28	—	2.68	2.35	—	2.61	V	$7\text{ V} \leq V_{IN} \leq 20\text{ V}$, $1.0\text{ mA} \leq I_{OUT} \leq 40\text{ mA}$ $V_{IN} = 9\text{ V}$, $1.0\text{ mA} \leq I_{OUT} \leq 70\text{ mA}$
		2.28	—	2.68	2.35	—	2.61		
Quiescent current	I_Q	—	3.0	6.0	—	3.0	6.0	mA	$T_j = 25^\circ\text{C}$
Quiescent current change	δI_Q	—	—	1.5	—	—	1.5	mA	$T_j = 25^\circ\text{C}$ $8\text{ V} \leq V_{IN} \leq 20\text{ V}$ $1.0\text{ mA} \leq I_{OUT} \leq 40\text{ mA}$
		—	—	0.2	—	—	0.1		
Ripple rejection ratio	R_{REJ}	—	60	—	—	60	—	dB	$f = 120\text{ Hz}$, $8.0\text{ V} \leq V_{IN} < 18\text{ V}$, $T_j = 25^\circ\text{C}$
Temperature coefficient of output voltage	$\delta V_{OUT}/\delta T_j$	—	+0.2	—	—	+0.2	—	mV/°C	$I_{OUT} = 5\text{ mA}$

HA178L05 Electrical Characteristics
 $(V_{IN} = 10\text{ V}, I_{OUT} = 40\text{ mA}, 0^{\circ}\text{C} \leq T_j \leq 125^{\circ}\text{C}, C_{IN} = 0.33\ \mu\text{F}, C_{OUT} = 0.1\ \mu\text{F})$

Item	Symbol	HA178L05P HA178L05			HA178L05PA HA178L05A HA178L05UA			Unit	Test Conditions
		Min	Typ	Max	Min	Typ	Max		
Output voltage	V_{OUT}	4.68	5.0	5.32	4.8	5.0	5.2	V	$T_j = 25^{\circ}\text{C}$
Line regulation	δV_{OLINE}	—	55	200	—	55	150	mV	$T_j = 25^{\circ}\text{C}$ $7\text{ V} \leq V_{IN} \leq 20\text{ V}$ $8\text{ V} \leq V_{IN} \leq 20\text{ V}$
		—	45	150	—	45	100		
Load regulation	δV_{LOAD}	—	16	—	—	16	—	mV	$T_j = 25^{\circ}\text{C}$ $1.0\text{ mA} \leq I_{OUT} \leq 150\text{ mA}$ $1.0\text{ mA} \leq I_{OUT} \leq 100\text{ mA}$ $1.0\text{ mA} \leq I_{OUT} \leq 40\text{ mA}$
		—	11	60	—	11	60		
		—	5.0	30	—	5.0	30		
Output voltage	V_{OUT}	4.6	—	5.4	4.75	—	5.25	V	$7\text{ V} \leq V_{IN} \leq 20\text{ V}$, $1.0\text{ mA} \leq I_{OUT} \leq 40\text{ mA}$ $V_{IN} = 10\text{ V}, 1.0\text{ mA} \leq I_{OUT} \leq 70\text{ mA}$
		4.6	—	5.4	4.75	—	5.25		
Quiescent current	I_Q	—	3.0	6.0	—	3.0	6.0	mA	$T_j = 25^{\circ}\text{C}$
Quiescent current change	δI_Q	—	—	1.5	—	—	1.5	mA	$T_j = 25^{\circ}\text{C}$ $8.0\text{ V} \leq V_{IN} \leq 20\text{ V}$ $1.0\text{ mA} \leq I_{OUT} \leq 40\text{ mA}$
		—	—	0.2	—	—	0.1		
Ripple rejection ratio	R_{REJ}	—	58	—	—	58	—	dB	$f = 120\text{ Hz}$, $8.0\text{ V} \leq V_{IN} < 18\text{ V}, T_j = 25^{\circ}\text{C}$
Temperature coefficient of output voltage	$\delta V_{OUT}/\delta T_j$	—	+0.1	—	—	+0.1	—	mV/°C	$I_{OUT} = 5\text{ mA}$
Dropout voltage	V_{DROP}	—	1.7	—	—	1.7	—	V	$T_j = 25^{\circ}\text{C}$

HA178L00 Series

HA178L56 Electrical Characteristics

($V_{IN} = 11\text{ V}$, $I_{OUT} = 40\text{ mA}$, $0^\circ\text{C} \leq T_j \leq 125^\circ\text{C}$, $C_{IN} = 0.33\ \mu\text{F}$, $C_{OUT} = 0.1\ \mu\text{F}$)

Item	Symbol	HA178L56P HA178L56			HA178L56PA HA178L56A HA178L56UA			Unit	Test Conditions
		Min	Typ	Max	Min	Typ	Max		
Output voltage	V_{OUT}	5.24	5.6	5.96	5.38	5.6	5.82	V	$T_j = 25^\circ\text{C}$
Line regulation	δV_{OLINE}	—	50	200	—	50	150	mV	$T_j = 25^\circ\text{C}$ $7.6\text{ V} \leq V_{IN} \leq 21\text{ V}$ $8.5\text{ V} \leq V_{IN} \leq 21\text{ V}$
		—	45	150	—	45	100		
Load regulation	δV_{LOAD}	—	17	—	—	17	—	mV	$T_j = 25^\circ\text{C}$ $1.0\text{ mA} \leq I_{OUT} \leq 150\text{ mA}$ $1.0\text{ mA} \leq I_{OUT} \leq 100\text{ mA}$ $1.0\text{ mA} \leq I_{OUT} \leq 40\text{ mA}$
		—	11	60	—	11	60		
		—	5.0	30	—	5.0	30		
Output voltage	V_{OUT}	5.16	—	6.04	5.32	—	5.88	V	$7.6\text{ V} \leq V_{IN} \leq 21\text{ V}$, $1.0\text{ mA} \leq I_{OUT} \leq 40\text{ mA}$ $V_{IN} = 11\text{ V}$, $1.0\text{ mA} \leq I_{OUT} \leq 70\text{ mA}$
		5.16	—	6.04	5.32	—	5.88		
Quiescent current	I_Q	—	3.0	6.0	—	3.0	6.0	mA	$T_j = 25^\circ\text{C}$
Quiescent current change	δI_Q	—	—	1.5	—	—	1.5	mA	$T_j = 25^\circ\text{C}$ $8.5\text{ V} \leq V_{IN} \leq 2.0\text{ V}$ $1.0\text{ mA} \leq I_{OUT} \leq 40\text{ mA}$
		—	—	0.2	—	—	0.1		
Ripple rejection ratio	R_{REJ}	—	58	—	—	58	—	dB	$f = 120\text{ Hz}$, $8.5\text{ V} \leq V_{IN} < 18.5\text{ V}$, $T_j = 25^\circ\text{C}$
Temperature coefficient of output voltage	$\delta V_{OUT}/\delta T_j$	—	+0.1	—	—	+0.1	—	mV/°C	$I_{OUT} = 5\text{ mA}$
Dropout voltage	V_{DROP}	—	1.7	—	—	1.7	—	V	$T_j = 25^\circ\text{C}$

HA178L06 Electrical Characteristics
 $(V_{IN} = 11\text{ V}, I_{OUT} = 40\text{ mA}, 0^{\circ}\text{C} \leq T_j \leq 125^{\circ}\text{C}, C_{IN} = 0.33\ \mu\text{F}, C_{OUT} = 0.1\ \mu\text{F})$

Item	Symbol	HA178L06P HA178L06			HA178L06PA HA178L06A HA178L06UA			Unit	Test Conditions
		Min	Typ	Max	Min	Typ	Max		
Output voltage	V_{OUT}	5.61	6.0	6.39	5.76	6.0	6.24	V	$T_j = 25^{\circ}\text{C}$
Line regulation	δV_{OLINE}	—	50	200	—	50	150	mV	$T_j = 25^{\circ}\text{C}$ $8.1\text{ V} \leq V_{IN} \leq 21\text{ V}$ $9.0\text{ V} \leq V_{IN} \leq 21\text{ V}$
		—	45	150	—	45	110		
Load regulation	δV_{LOAD}	—	17.5	—	—	17.5	—	mV	$T_j = 25^{\circ}\text{C}$ $1.0\text{ mA} \leq I_{OUT} \leq 150\text{ mA}$ $1.0\text{ mA} \leq I_{OUT} \leq 100\text{ mA}$ $1.0\text{ mA} \leq I_{OUT} \leq 40\text{ mA}$
		—	12	70	—	12	70		
		—	5.5	35	—	5.5	35		
Output voltage	V_{OUT}	5.52	—	6.48	5.7	—	6.3	V	$8.1\text{ V} \leq V_{IN} \leq 21\text{ V}$, $1.0\text{ mA} \leq I_{OUT} \leq 40\text{ mA}$ $V_{IN} = 11\text{ V}, 1.0\text{ mA} \leq I_{OUT} \leq 70\text{ mA}$
		5.52	—	6.48	5.7	—	6.3		
Quiescent current	I_Q	—	3.0	6.0	—	3.0	6.0	mA	$T_j = 25^{\circ}\text{C}$
Quiescent current change	δI_Q	—	—	1.5	—	—	1.5	mA	$T_j = 25^{\circ}\text{C}$ $9.0\text{ V} \leq V_{IN} \leq 20\text{ V}$ $1.0\text{ mA} \leq I_{OUT} \leq 40\text{ mA}$
		—	—	0.2	—	—	0.1		
Ripple rejection ratio	R_{REJ}	—	57	—	—	57	—	dB	$f = 120\text{ Hz}$, $9.0\text{ V} \leq V_{IN} < 19\text{ V}, T_j = 25^{\circ}\text{C}$
Temperature coefficient of output voltage	$\delta V_{OUT}/\delta T_j$	—	+0.1	—	—	+0.1	—	mV/°C	$I_{OUT} = 5\text{ mA}$
Dropout voltage	V_{DROP}	—	1.7	—	—	1.7	—	V	$T_j = 25^{\circ}\text{C}$

HA178L00 Series

HA178L08 Electrical Characteristics

($V_{IN} = 14\text{ V}$, $I_{OUT} = 40\text{ mA}$, $0^\circ\text{C} \leq T_j \leq 125^\circ\text{C}$, $C_{IN} = 0.33\ \mu\text{F}$, $C_{OUT} = 0.1\ \mu\text{F}$)

Item	Symbol	HA178L08P HA178L08			HA178L08PA HA178L08A HA178L08UA			Unit	Test Conditions
		Min	Typ	Max	Min	Typ	Max		
Output voltage	V_{OUT}	7.48	8.0	8.52	7.7	8.0	8.3	V	$T_j = 25^\circ\text{C}$
Line regulation	δV_{OLINE}	—	20	200	—	20	175	mV	$T_j = 25^\circ\text{C}$ $10.5\text{ V} \leq V_{IN} \leq 23\text{ V}$ $11\text{ V} \leq V_{IN} \leq 23\text{ V}$
		—	12	150	—	12	125		
Load regulation	δV_{LOAD}	—	22	—	—	22	—	mV	$T_j = 25^\circ\text{C}$ $1.0\text{ mA} \leq I_{OUT} \leq 150\text{ mA}$ $1.0\text{ mA} \leq I_{OUT} \leq 100\text{ mA}$ $1.0\text{ mA} \leq I_{OUT} \leq 40\text{ mA}$
		—	15	80	—	15	80		
		—	7.0	40	—	7.0	40		
Output voltage	V_{OUT}	7.36	—	8.64	7.6	—	8.4	V	$10.5\text{ V} \leq V_{IN} \leq 23\text{ V}$, $1.0\text{ mA} \leq I_{OUT} \leq 40\text{ mA}$ $V_{IN} = 14\text{ V}$, $1.0\text{ mA} \leq I_{OUT} \leq 70\text{ mA}$
		7.36	—	8.64	7.6	—	8.4		
Quiescent current	I_Q	—	3.0	6.5	—	3.0	6.5	mA	$T_j = 25^\circ\text{C}$
Quiescent current change	δI_Q	—	—	1.5	—	—	1.5	mA	$T_j = 25^\circ\text{C}$ $11\text{ V} \leq V_{IN} \leq 23\text{ V}$ $1.0\text{ mA} \leq I_{OUT} \leq 40\text{ mA}$
		—	—	0.2	—	—	0.1		
Ripple rejection ratio	R_{REJ}	—	55	—	—	55	—	dB	$f = 120\text{ Hz}$, $12\text{ V} \leq V_{IN} < 23\text{ V}$, $T_j = 25^\circ\text{C}$
Temperature coefficient of output voltage	$\delta V_{OUT}/\delta T_j$	—	-0.1	—	—	-0.1	—	mV/°C	$I_{OUT} = 5\text{ mA}$
Dropout voltage	V_{DROP}	—	1.7	—	—	1.7	—	V	$T_j = 25^\circ\text{C}$

HA178L09 Electrical Characteristics
 $(V_{IN} = 15\text{ V}, I_{OUT} = 40\text{ mA}, 0^{\circ}\text{C} \leq T_j \leq 125^{\circ}\text{C}, C_{IN} = 0.33\ \mu\text{F}, C_{OUT} = 0.1\ \mu\text{F})$

Item	Symbol	HA178L09P HA178L09			HA178L09PA HA178L09A HA178L09UA			Unit	Test Conditions
		Min	Typ	Max	Min	Typ	Max		
Output voltage	V_{OUT}	8.42	9.0	9.58	8.64	9.0	9.36	V	$T_j = 25^{\circ}\text{C}$
Line regulation	δV_{OLINE}	—	80	230	—	80	200	mV	$T_j = 25^{\circ}\text{C}$ $11.4\text{ V} \leq V_{IN} \leq 24\text{ V}$ $12\text{ V} \leq V_{IN} \leq 24\text{ V}$
		—	20	160	—	20	160		
Load regulation	δV_{LOAD}	—	24.5	—	—	24.5	—	mV	$T_j = 25^{\circ}\text{C}$ $1.0\text{ mA} \leq I_{OUT} \leq 150\text{ mA}$ $1.0\text{ mA} \leq I_{OUT} \leq 100\text{ mA}$ $1.0\text{ mA} \leq I_{OUT} \leq 40\text{ mA}$
		—	17	90	—	17	90		
		—	8.0	45	—	8.0	45		
Output voltage	V_{OUT}	8.28	—	9.72	8.55	—	9.45	V	$11.4\text{ V} \leq V_{IN} \leq 24\text{ V},$ $1.0\text{ mA} \leq I_{OUT} \leq 40\text{ mA}$ $V_{IN} = 15\text{ V}, 1.0\text{ mA} \leq I_{OUT} \leq 70\text{ mA}$
		8.28	—	9.72	8.55	—	9.45		
Quiescent current	I_Q	—	3.1	6.5	—	3.1	6.5	mA	$T_j = 25^{\circ}\text{C}$
Quiescent current change	δI_Q	—	—	1.5	—	—	1.5	mA	$T_j = 25^{\circ}\text{C}$ $12\text{ V} \leq V_{IN} \leq 24\text{ V}$ $1.0\text{ mA} \leq I_{OUT} \leq 40\text{ mA}$
		—	—	0.2	—	—	0.1		
Ripple rejection ratio	R_{REJ}	—	55	—	—	55	—	dB	$f = 120\text{ Hz},$ $12\text{ V} \leq V < 24\text{ V}, T_j = 25^{\circ}\text{C}$
Temperature coefficient of output voltage	$\delta V_{OUT}/\delta T_j$	—	-0.15	—	—	-0.15	—	mV/°C	$I_{OUT} = 5\text{ mA}$
Dropout voltage	V_{DROP}	—	1.7	—	—	1.7	—	V	$T_j = 25^{\circ}\text{C}$

HA178L00 Series

HA178L10 Electrical Characteristics

($V_{IN} = 16\text{ V}$, $I_{OUT} = 40\text{ mA}$, $0^\circ\text{C} \leq T_j \leq 125^\circ\text{C}$, $C_{IN} = 0.33\ \mu\text{F}$, $C_{OUT} = 0.1\ \mu\text{F}$)

Item	Symbol	HA178L10P HA178L10			HA178L10PA HA178L10A HA178L10UA			Unit	Test Conditions
		Min	Typ	Max	Min	Typ	Max		
Output voltage	V_{OUT}	9.35	10	10.65	9.6	10	10.4	V	$T_j = 25^\circ\text{C}$
Line regulation	δV_{OLINE}	—	80	230	—	80	230	mV	$T_j = 25^\circ\text{C}$ $12.5\text{ V} \leq V_{IN} \leq 25\text{ V}$ $13\text{ V} \leq V_{IN} \leq 25\text{ V}$
		—	30	170	—	30	170		
Load regulation	δV_{LOAD}	—	26	—	—	26	—	mV	$T_j = 25^\circ\text{C}$ $1.0\text{ mA} \leq I_{OUT} \leq 150\text{ mA}$ $1.0\text{ mA} \leq I_{OUT} \leq 100\text{ mA}$ $1.0\text{ mA} \leq I_{OUT} \leq 40\text{ mA}$
		—	18	90	—	18	90		
		—	8.5	45	—	8.5	45		
Output voltage	V_{OUT}	9.2	—	10.8	9.5	—	10.5	V	$12.5\text{ V} \leq V_{IN} \leq 25\text{ V}$, $1.0\text{ mA} \leq I_{OUT} \leq 40\text{ mA}$ $V_{IN} = 16\text{ V}$, $1.0\text{ mA} \leq I_{OUT} \leq 70\text{ mA}$
		9.2	—	10.8	9.5	—	10.5		
Quiescent current	I_Q	—	3.1	6.5	—	3.1	6.5	mA	$T_j = 25^\circ\text{C}$
Quiescent current change	δI_Q	—	—	1.5	—	—	1.5	mA	$T_j = 25^\circ\text{C}$ $13\text{ V} \leq V_{IN} \leq 25\text{ V}$ $1.0\text{ mA} \leq I_{OUT} \leq 40\text{ mA}$
		—	—	0.2	—	—	0.1		
Ripple rejection ratio	R_{REJ}	—	54	—	—	54	—	dB	$f = 120\text{ Hz}$, $13\text{ V} \leq V_{IN} < 24\text{ V}$, $T_j = 25^\circ\text{C}$
Temperature coefficient of output voltage	$\delta V_{OUT}/\delta T_j$	—	-0.2	—	—	-0.2	—	mV/°C	$I_{OUT} = 5\text{ mA}$
Dropout voltage	V_{DROP}	—	1.7	—	—	1.7	—	V	$T_j = 25^\circ\text{C}$

HA178L12 Electrical Characteristics
 $(V_{IN} = 19\text{ V}, I_{OUT} = 40\text{ mA}, 0^{\circ}\text{C} \leq T_j \leq 125^{\circ}\text{C}, C_{IN} = 0.33\ \mu\text{F}, C_{OUT} = 0.1\ \mu\text{F})$

Item	Symbol	HA178L12P HA178L12			HA178L12PA HA178L12A HA178L12UA			Unit	Test Conditions
		Min	Typ	Max	Min	Typ	Max		
Output voltage	V_{OUT}	11.22	12	12.78	11.5	12	12.5	V	$T_j = 25^{\circ}\text{C}$
Line regulation	δV_{OLINE}	—	120	250	—	120	250	mV	$T_j = 25^{\circ}\text{C}$ $14.5\text{ V} \leq V_{IN} \leq 27\text{ V}$ $16\text{ V} \leq V_{IN} \leq 27\text{ V}$
		—	100	200	—	100	200		
Load regulation	δV_{LOAD}	—	28.5	—	—	28.5	—	mV	$T_j = 25^{\circ}\text{C}$ $1.0\text{ mA} \leq I_{OUT} \leq 150\text{ mA}$ $1.0\text{ mA} \leq I_{OUT} \leq 100\text{ mA}$ $1.0\text{ mA} \leq I_{OUT} \leq 40\text{ mA}$
		—	20	100	—	20	100		
		—	10	50	—	10	50		
Output voltage	V_{OUT}	11.04	—	12.96	11.4	—	12.6	V	$14.5\text{ V} \leq V_{IN} \leq 27\text{ V},$ $1.0\text{ mA} \leq I_{OUT} \leq 40\text{ mA}$ $V_{IN} = 19\text{ V}, 1.0\text{ mA} \leq I_{OUT} \leq 70\text{ mA}$
		11.04	—	12.96	11.4	—	12.6		
Quiescent current	I_Q	—	3.1	6.5	—	3.1	6.5	mA	$T_j = 25^{\circ}\text{C}$
Quiescent current change	δI_Q	—	—	1.5	—	—	1.5	mA	$T_j = 25^{\circ}\text{C}$ $16\text{ V} \leq V_{IN} \leq 27\text{ V}$ $1.0\text{ mA} \leq I_{OUT} \leq 40\text{ mA}$
		—	—	0.2	—	—	0.1		
Ripple rejection ratio	R_{REJ}	—	52	—	—	52	—	dB	$f = 120\text{ Hz},$ $15\text{ V} \leq V_{IN} < 25\text{ V}, T_j = 25^{\circ}\text{C}$
Temperature coefficient of output voltage	$\delta V_{OUT}/\delta T_j$	—	-0.3	—	—	-0.3	—	mV/°C	$I_{OUT} = 5\text{ mA}$
Dropout voltage	V_{DROP}	—	1.7	—	—	1.7	—	V	$T_j = 25^{\circ}\text{C}$

HA178L00 Series

HA178L15 Electrical Characteristics

($V_{IN} = 23\text{ V}$, $I_{OUT} = 40\text{ mA}$, $0^\circ\text{C} \leq T_j \leq 125^\circ\text{C}$, $C_{IN} = 0.33\ \mu\text{F}$, $C_{OUT} = 0.1\ \mu\text{F}$)

Item	Symbol	HA178L15P HA178L15			HA178L15PA HA178L15A HA178L15UA			Unit	Test Conditions
		Min	Typ	Max	Min	Typ	Max		
Output voltage	V_{OUT}	14.03	15	15.97	14.4	15	15.6	V	$T_j = 25^\circ\text{C}$
Line regulation	δV_{OLINE}	—	130	300	—	130	300	mV	$T_j = 25^\circ\text{C}$ $17.5\text{ V} \leq V_{IN} \leq 30\text{ V}$ $20\text{ V} \leq V_{IN} \leq 30\text{ V}$
		—	110	250	—	110	250		
Load regulation	δV_{LOAD}	—	36	—	—	36	—	mV	$T_j = 25^\circ\text{C}$ $1.0\text{ mA} \leq I_{OUT} \leq 150\text{ mA}$ $1.0\text{ mA} \leq I_{OUT} \leq 100\text{ mA}$ $1.0\text{ mA} \leq I_{OUT} \leq 40\text{ mA}$
		—	25	150	—	25	150		
		—	12	75	—	12	75		
Output voltage	V_{OUT}	13.8	—	16.2	14.25	—	15.75	V	$17.5\text{ V} \leq V_{IN} \leq 30\text{ V}$, $1.0\text{ mA} \leq I_{OUT} \leq 40\text{ mA}$ $V_{IN} = 23\text{ V}$, $1.0\text{ mA} \leq I_{OUT} \leq 70\text{ mA}$
		13.8	—	16.2	14.25	—	15.75		
Quiescent current	I_Q	—	3.2	6.5	—	3.2	6.5	mA	$T_j = 25^\circ\text{C}$
Quiescent current change	δI_Q	—	—	1.5	—	—	1.5	mA	$T_j = 25^\circ\text{C}$ $20\text{ V} \leq V_{IN} \leq 30\text{ V}$ $1.0\text{ mA} \leq I_{OUT} \leq 40\text{ mA}$
		—	—	0.2	—	—	0.1		
Ripple rejection ratio	R_{REJ}	—	49	—	—	49	—	dB	$f = 120\text{ Hz}$, $18.5\text{ V} \leq V_{IN} < 28.5\text{ V}$, $T_j = 25^\circ\text{C}$
Temperature coefficient of output voltage	$\delta V_{OUT}/\delta T_j$	—	-0.5	—	—	-0.5	—	mV/°C	$I_{OUT} = 5\text{ mA}$
Dropout voltage	V_{DROP}	—	1.7	—	—	1.7	—	V	$T_j = 25^\circ\text{C}$

Characteristic Curves

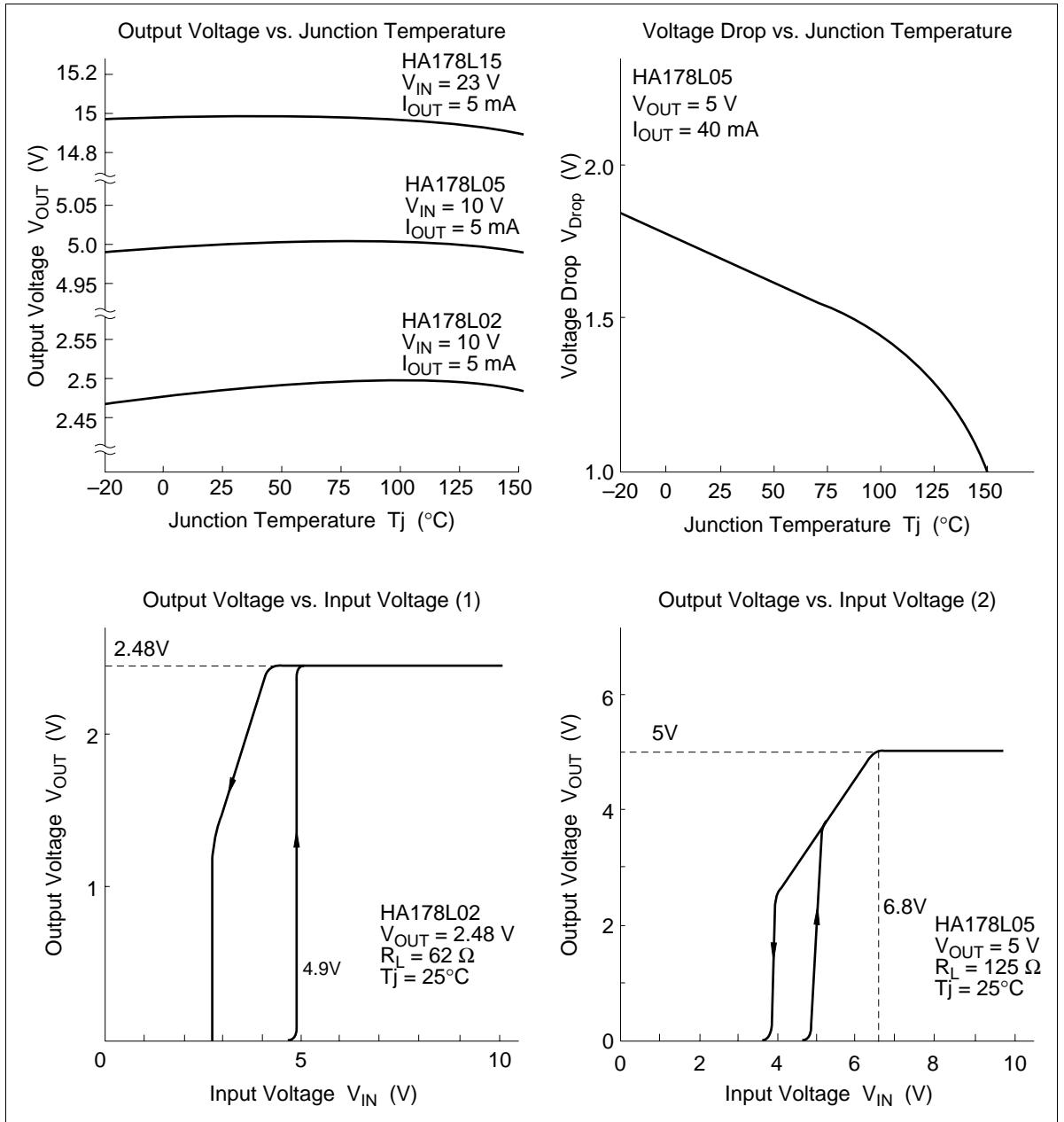

Output Voltage vs. Input Voltage (3)

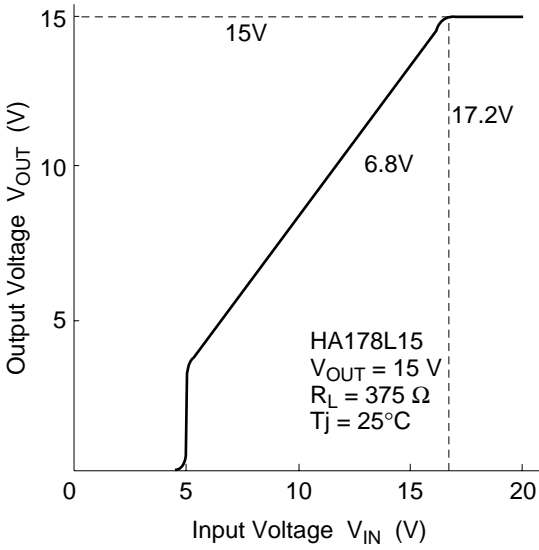

Quiescent Current vs. Input Voltage (1)

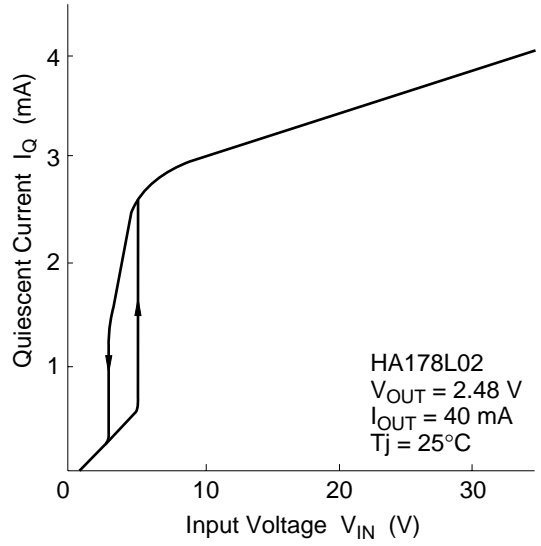

Quiescent Current vs. Input Voltage (2)

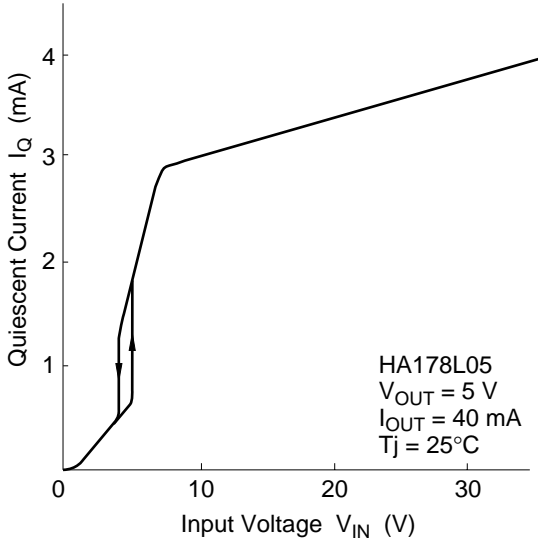

Quiescent Current vs. Input Voltage (3)

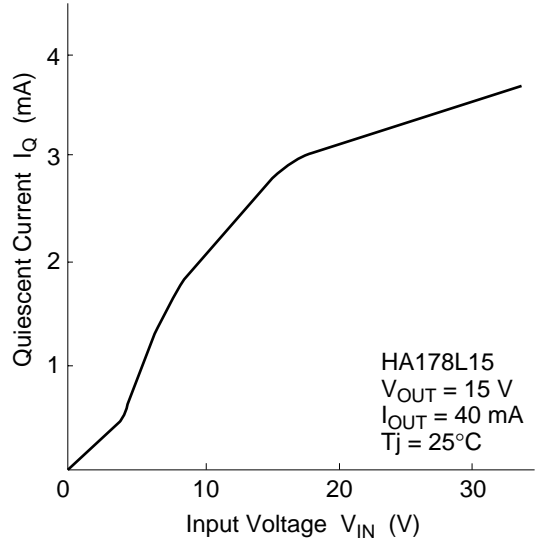

Output Voltage vs. Output Current

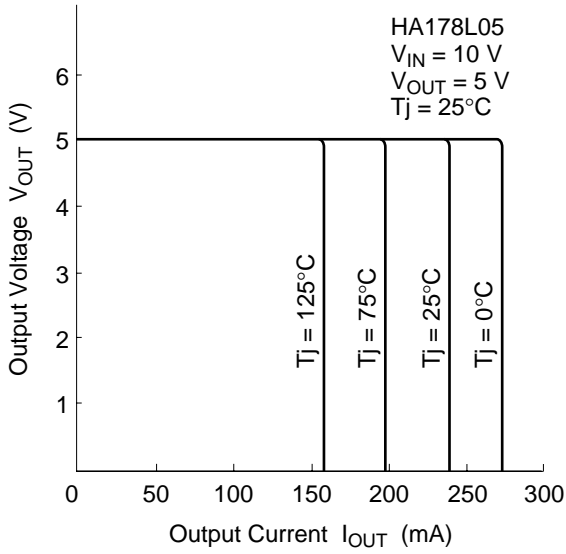

Quiescent Current vs. Junction Temperature (1)

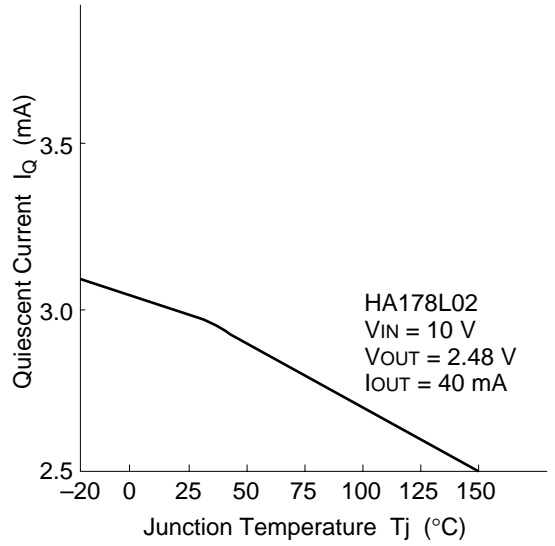

Quiescent Current vs. Junction Temperature (2)

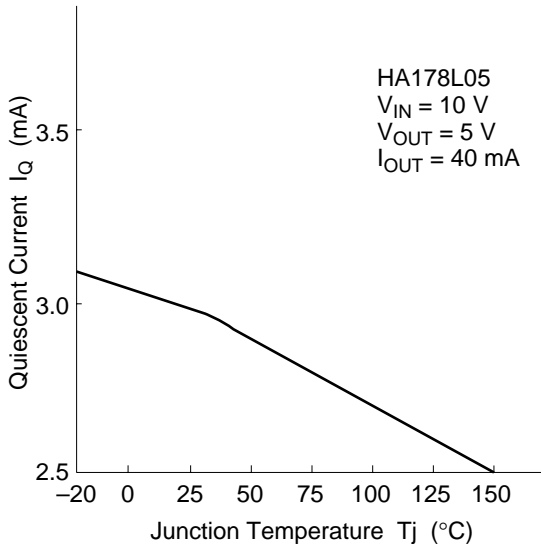

Quiescent Current vs. Junction Temperature (3)

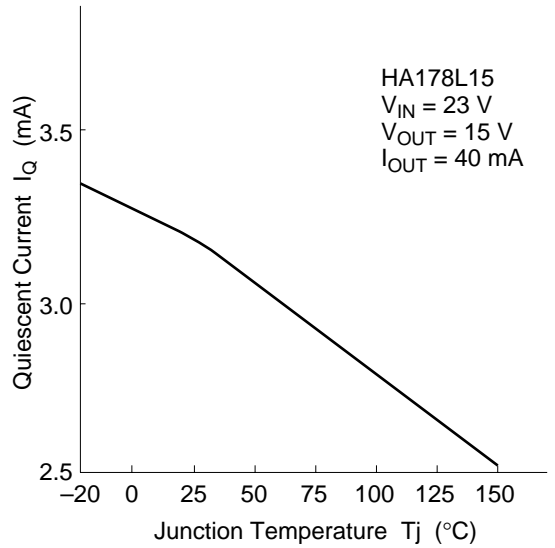

Ripple Rejection Ratio vs. Frequency (1)

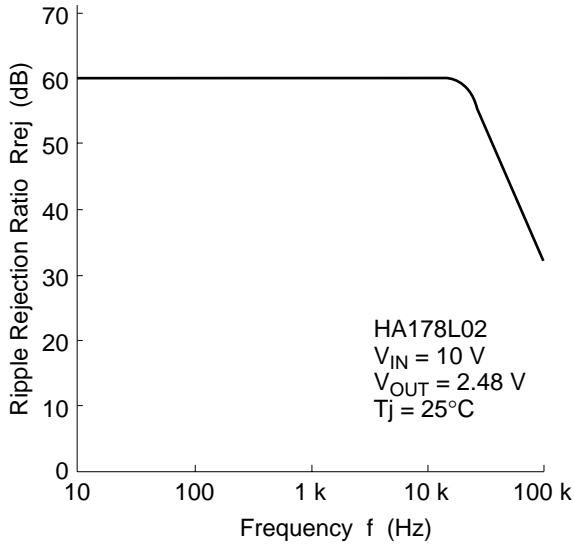

Ripple Rejection Ratio vs. Frequency (2)

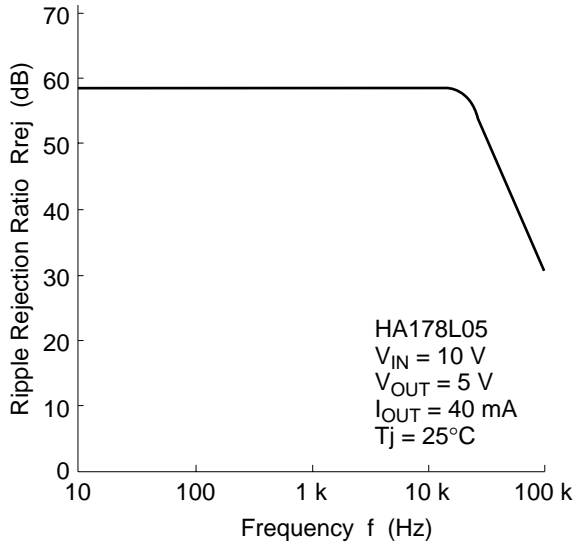

Ripple Rejection Ratio vs. Frequency (3)

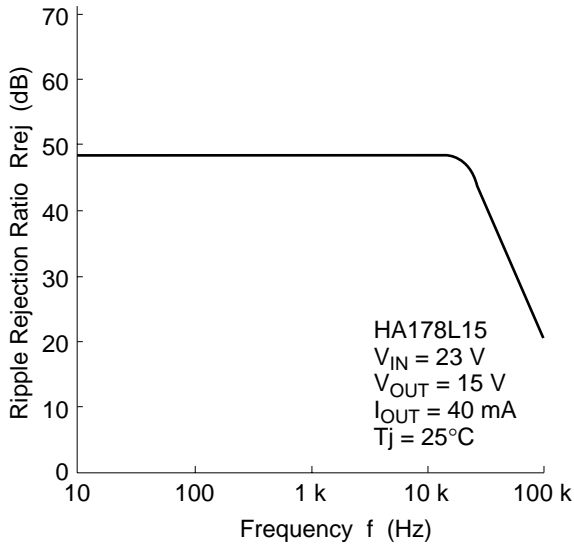

Hysteresis Voltage vs. Output Voltage

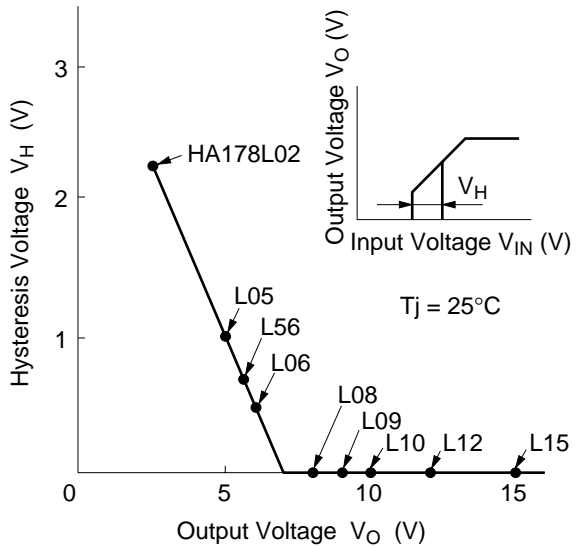

Package Dimensions

Unit: mm

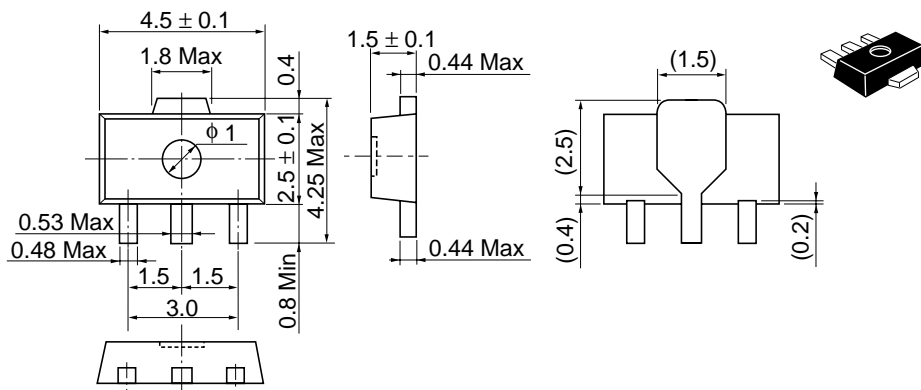

Hitachi Code	UPAK
JEDEC	—
EIAJ	Conforms
Mass (reference value)	0.050 g

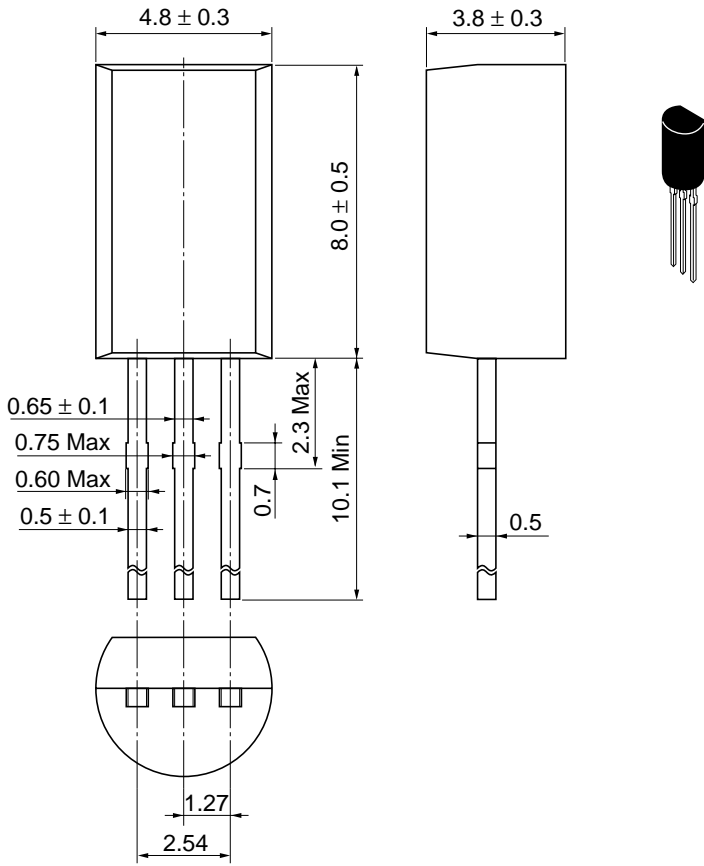

Hitachi Code	TO-92 Mod
JEDEC	—
EIAJ	Conforms
Mass (reference value)	0.35 g

Cautions

1. Hitachi neither warrants nor grants licenses of any rights of Hitachi's or any third party's patent, copyright, trademark, or other intellectual property rights for information contained in this document. Hitachi bears no responsibility for problems that may arise with third party's rights, including intellectual property rights, in connection with use of the information contained in this document.
2. Products and product specifications may be subject to change without notice. Confirm that you have received the latest product standards or specifications before final design, purchase or use.
3. Hitachi makes every attempt to ensure that its products are of high quality and reliability. However, contact Hitachi's sales office before using the product in an application that demands especially high quality and reliability or where its failure or malfunction may directly threaten human life or cause risk of bodily injury, such as aerospace, aeronautics, nuclear power, combustion control, transportation, traffic, safety equipment or medical equipment for life support.
4. Design your application so that the product is used within the ranges guaranteed by Hitachi particularly for maximum rating, operating supply voltage range, heat radiation characteristics, installation conditions and other characteristics. Hitachi bears no responsibility for failure or damage when used beyond the guaranteed ranges. Even within the guaranteed ranges, consider normally foreseeable failure rates or failure modes in semiconductor devices and employ systemic measures such as fail-safes, so that the equipment incorporating Hitachi product does not cause bodily injury, fire or other consequential damage due to operation of the Hitachi product.
5. This product is not designed to be radiation resistant.
6. No one is permitted to reproduce or duplicate, in any form, the whole or part of this document without written approval from Hitachi.
7. Contact Hitachi's sales office for any questions regarding this document or Hitachi semiconductor products.

HITACHI

Hitachi, Ltd.

Semiconductor & Integrated Circuits.
 Nippon Bldg., 2-6-2, Ohite-machi, Chiyoda-ku, Tokyo 100-0004, Japan
 Tel: Tokyo (03) 3270-2111 Fax: (03) 3270-5109

URL NorthAmerica : <http://semiconductor.hitachi.com/>
 Europe : <http://www.hitachi-eu.com/hel/ecg>
 Asia (Singapore) : <http://www.has.hitachi.com.sg/grp3/sicd/index.htm>
 Asia (Taiwan) : http://www.hitachi.com.tw/E/Product/SICD_Frame.htm
 Asia (HongKong) : <http://www.hitachi.com.hk/eng/bo/grp3/index.htm>
 Japan : <http://www.hitachi.co.jp/Sicd/indx.htm>

For further information write to:

<p>Hitachi Semiconductor (America) Inc. 179 East Tasman Drive, San Jose, CA 95134 Tel: <1> (408) 433-1990 Fax: <1> (408) 433-0223</p>	<p>Hitachi Europe GmbH Electronic components Group Dornacher Straße 3 D-85622 Feldkirchen, Munich Germany Tel: <49> (89) 9 9180-0 Fax: <49> (89) 9 29 30 00</p> <p>Hitachi Europe Ltd. Electronic Components Group. Whitebrook Park Lower Cookham Road Maidenhead Berkshire SL6 8YA, United Kingdom Tel: <44> (1628) 585000 Fax: <44> (1628) 778322</p>	<p>Hitachi Asia Pte. Ltd. 16 Collyer Quay #20-00 Hitachi Tower Singapore 049318 Tel: 535-2100 Fax: 535-1533</p> <p>Hitachi Asia Ltd. Taipei Branch Office 3F, Hung Kuo Building, No.167, Tun-Hwa North Road, Taipei (105) Tel: <886> (2) 2718-3666 Fax: <886> (2) 2718-8180</p>	<p>Hitachi Asia (Hong Kong) Ltd. Group III (Electronic Components) 7/F., North Tower, World Finance Centre, Harbour City, Canton Road, Tsim Sha Tsui, Kowloon, Hong Kong Tel: <852> (2) 735 9218 Fax: <852> (2) 730 0281 Telex: 40815 HITEC HX</p>
--	--	---	---

Copyright ' Hitachi, Ltd., 1998. All rights reserved. Printed in Japan.