

PN2369A

MMBT2369A

MMPQ2369

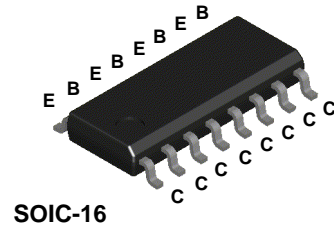
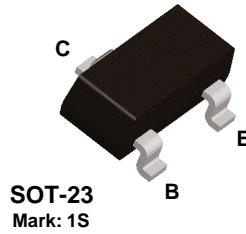
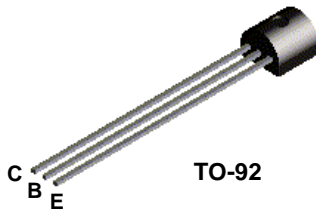

NPN Switching Transistor

This device is designed for high speed saturation switching at collector currents of 10 mA to 100 mA. Sourced from Process 21.

Absolute Maximum Ratings* TA = 25°C unless otherwise noted

Symbol	Parameter	Value	Units
V _{CEO}	Collector-Emitter Voltage	15	V
V _{CBO}	Collector-Base Voltage	40	V
V _{EBO}	Emitter-Base Voltage	4.5	V
I _C	Collector Current - Continuous	200	mA
T _J , T _{stg}	Operating and Storage Junction Temperature Range	-55 to +150	°C

*These ratings are limiting values above which the serviceability of any semiconductor device may be impaired.

NOTES:

- 1) These ratings are based on a maximum junction temperature of 150 degrees C.
- 2) These are steady state limits. The factory should be consulted on applications involving pulsed or low duty cycle operations.

Thermal Characteristics TA = 25°C unless otherwise noted

Symbol	Characteristic	Max			Units
		PN2369A	MMBT2369A*	MMPQ2369	
P _D	Total Device Dissipation	350	225	1,000	mW
	Derate above 25°C	2.8	1.8	8.0	mW/°C
R _{θJC}	Thermal Resistance, Junction to Case	125			°C/W
R _{θJA}	Thermal Resistance, Junction to Ambient Effective 4 Die Each Die	357	556		°C/W
				125	°C/W
				240	°C/W

* Device mounted on FR-4 PCB 1.6" X 1.6" X 0.06."

NPN Switching Transistor

(continued)

Electrical Characteristics

TA = 25°C unless otherwise noted

Symbol	Parameter	Test Conditions	Min	Max	Units
OFF CHARACTERISTICS					
$V_{(BR)CEO}$	Collector-Emitter Breakdown Voltage*	$I_C = 10 \text{ mA}, I_B = 0$	15		V
$V_{(BR)CES}$	Collector-Emitter Breakdown Voltage	$I_C = 10 \text{ } \mu\text{A}, V_{BE} = 0$	40		V
$V_{(BR)CBO}$	Collector-Base Breakdown Voltage	$I_C = 10 \text{ } \mu\text{A}, I_E = 0$	40		V
$V_{(BR)EBO}$	Emitter-Base Breakdown Voltage	$I_E = 10 \text{ } \mu\text{A}, I_C = 0$	4.5		V
I_{CBO}	Collector Cutoff Current	$V_{CB} = 20 \text{ V}, I_E = 0$ $V_{CB} = 20 \text{ V}, I_E = 0, T_A = 125^\circ\text{C}$		0.4 30	μA μA

ON CHARACTERISTICS

h_{FE}	DC Current Gain*	$I_C = 10 \text{ mA}, V_{CE} = 1.0 \text{ V}$ $I_C = 10 \text{ mA}, V_{CE} = 0.35 \text{ V}, T_A = -55^\circ\text{C}$ $I_C = 100 \text{ mA}, V_{CE} = 2.0 \text{ V}$	40 20 20	120	
$V_{CE(sat)}$	Collector-Emitter Saturation Voltage*	$I_C = 10 \text{ mA}, I_B = 1.0 \text{ mA}$ $I_C = 10 \text{ mA}, I_B = 1.0 \text{ mA}, T_A = 125^\circ\text{C}$ $I_C = 30 \text{ mA}, I_B = 3.0 \text{ mA}$ $I_C = 100 \text{ mA}, I_B = 10 \text{ mA}$		0.2 0.3 0.25 0.5	V V V V
$V_{BE(sat)}$	Base-Emitter Saturation Voltage	$I_C = 10 \text{ mA}, I_B = 1.0 \text{ mA}$ $I_C = 10 \text{ mA}, I_B = 1.0 \text{ mA}, T_A = -55^\circ\text{C}$ $I_C = 10 \text{ mA}, I_B = 1.0 \text{ mA}, T_A = 125^\circ\text{C}$ $I_C = 30 \text{ mA}, I_B = 3.0 \text{ mA}$ $I_C = 100 \text{ mA}, I_B = 10 \text{ mA}$	0.7 0.59	0.85 1.02	V V V V V

SMALL SIGNAL CHARACTERISTICS

C_{obo}	Output Capacitance	$V_{CB} = 5.0 \text{ V}, I_E = 0, f = 1.0 \text{ MHz}$		4.0	pF
C_{ibo}	Input Capacitance	$V_{EB} = 0.5 \text{ V}, I_C = 0, f = 1.0 \text{ MHz}$		5.0	pF
h_{fe}	Small-Signal Current Gain	$I_C = 10 \text{ mA}, V_{CE} = 10 \text{ V},$ $R_G = 2.0 \text{ k}\Omega, f = 100 \text{ MHz}$	5.0		

SWITCHING CHARACTERISTICS (except MMPQ2369)

t_s	Storage Time	$I_{B1} = I_{B2} = I_C = 10 \text{ mA}$		13	ns
t_{on}	Turn-On Time	$V_{CC} = 3.0 \text{ V}, I_C = 10 \text{ mA},$ $I_{B1} = 3.0 \text{ mA}$		12	ns
t_{off}	Turn-Off Time	$V_{CC} = 3.0 \text{ V}, I_C = 10 \text{ mA},$ $I_{B1} = 3.0 \text{ mA}, I_{B2} = 1.5 \text{ mA}$		18	ns

*Pulse Test: Pulse Width $\leq 300 \text{ } \mu\text{s}$, Duty Cycle $\leq 2.0\%$

Spice Model

NPN (Is=44.14f Xti=3 Eg=1.11 Vaf=100 Bf=78.32 Ne=1.389 Ise=91.95f Ikf=.3498 Xtb=1.5 Br=12.69m Nc=2 Isc=0 Ikr=0 Rc=.6 Cjc=2.83p Mjc=86.19m Vjc=.75 Fc=.5 Cje=4.5p Mje=.2418 Vje=.75 Tr=1.073u Tf=227.6p Itf=.3 Vtf=4 Xtf=4 Rb=10)

PN2369A / MMBT2369A / MMPQ2369

DC Typical Characteristics

DC Current Gain vs Collector Current

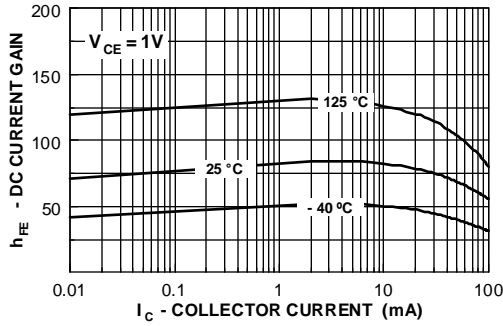

Collector-Emitter Saturation Voltage vs Collector Current

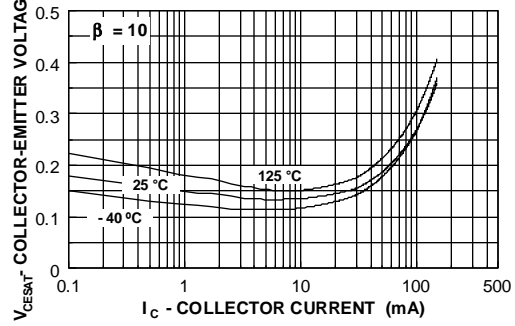

Base-Emitter Saturation Voltage vs Collector Current

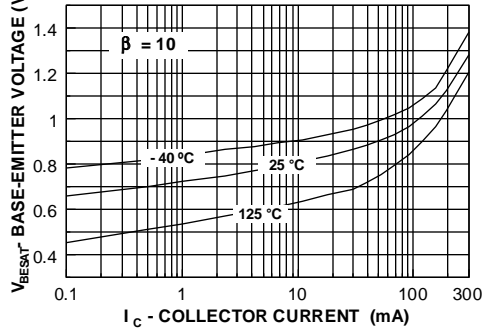

Base-Emitter ON Voltage vs Collector Current

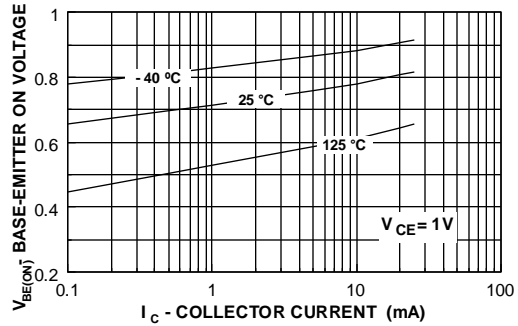

Collector-Cutoff Current vs Ambient Temperature

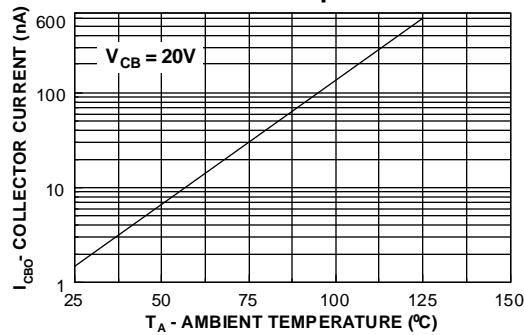

NPN Switching Transistor

(continued)

PN2369A / MMBT2369A / MMPO2369

AC Typical Characteristics

Output Capacitances vs. Reverse Bias Voltage

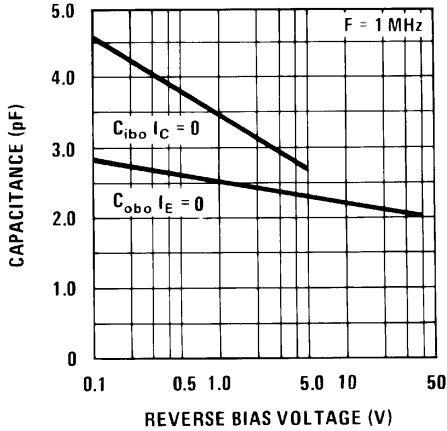

Switching Times vs. Collector Current

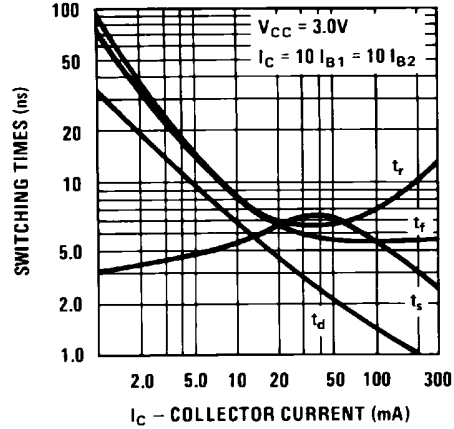

Switching Times vs. Ambient Temperature

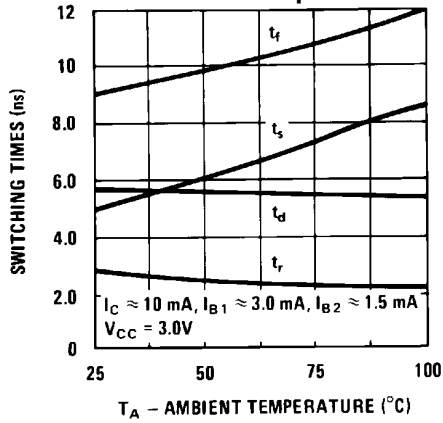

Storage Time vs. Turn On and Turn Off Base Currents

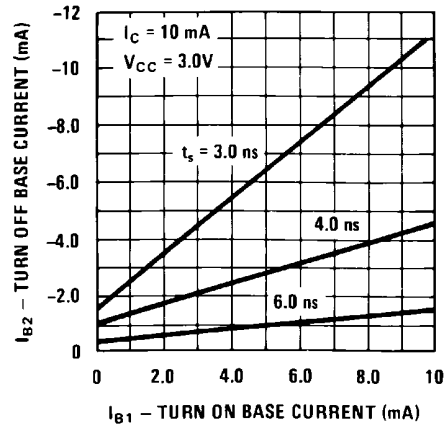

Storage Time vs. Turn On and Turn Off Base Currents

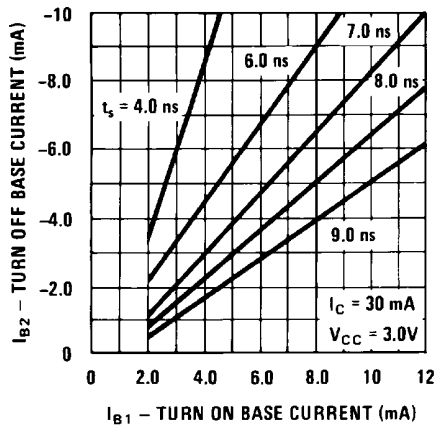

Storage Time vs. Turn On and Turn Off Base Currents

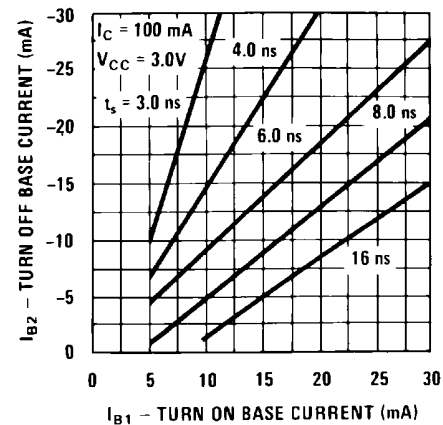

AC Typical Characteristics (continued)

Fall Time vs. Turn On and Turn Off Base Currents

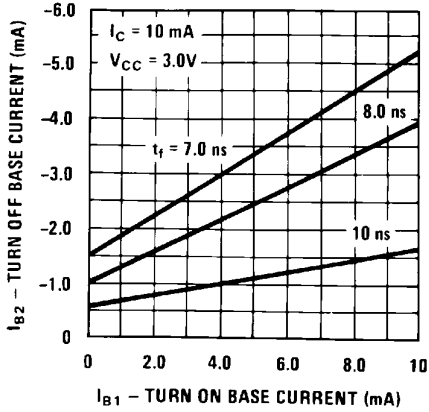

Fall Time vs. Turn On and Turn Off Base Currents

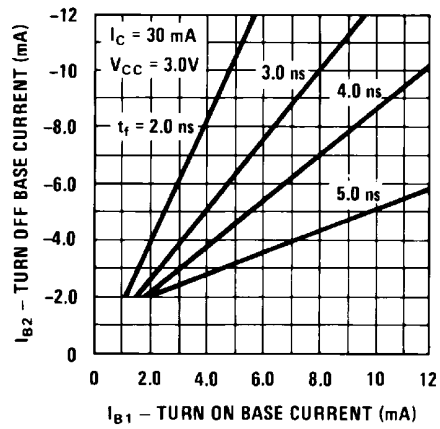

Fall Time vs. Turn On and Turn Off Base Currents

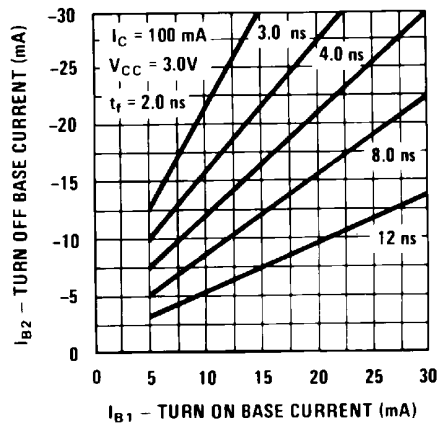

Delay Time vs. Base-Emitter OFF Voltage and Turn On Base Current

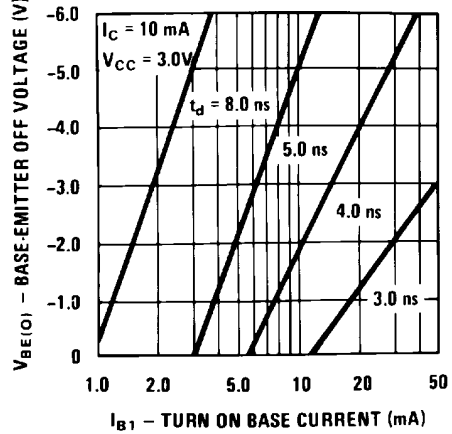

Rise Time vs. Turn On Base Current and Collector Current

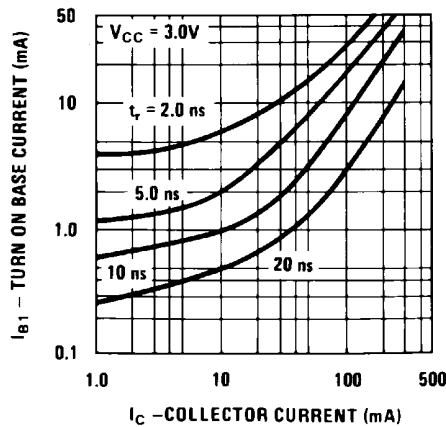

AC Typical Characteristics (continued)

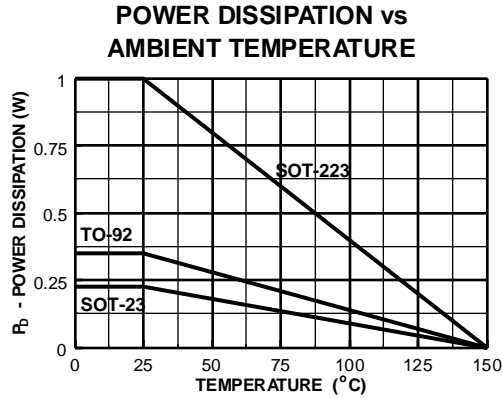

Test Circuits

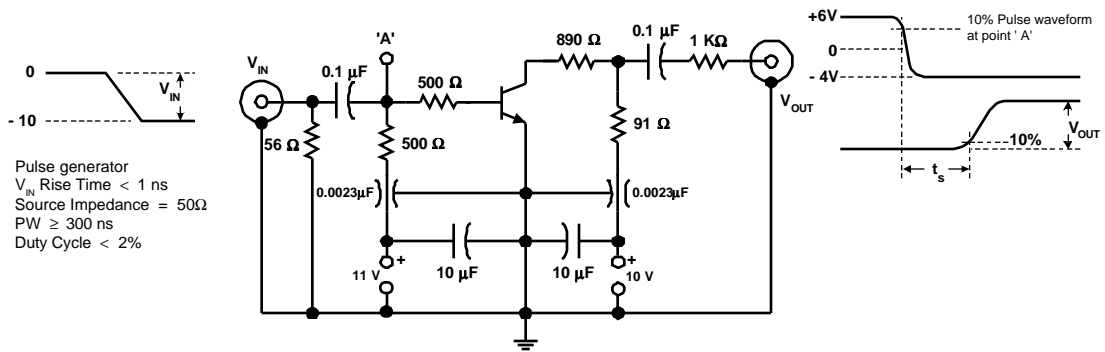

FIGURE 1: Charge Storage Time Measurement Circuit

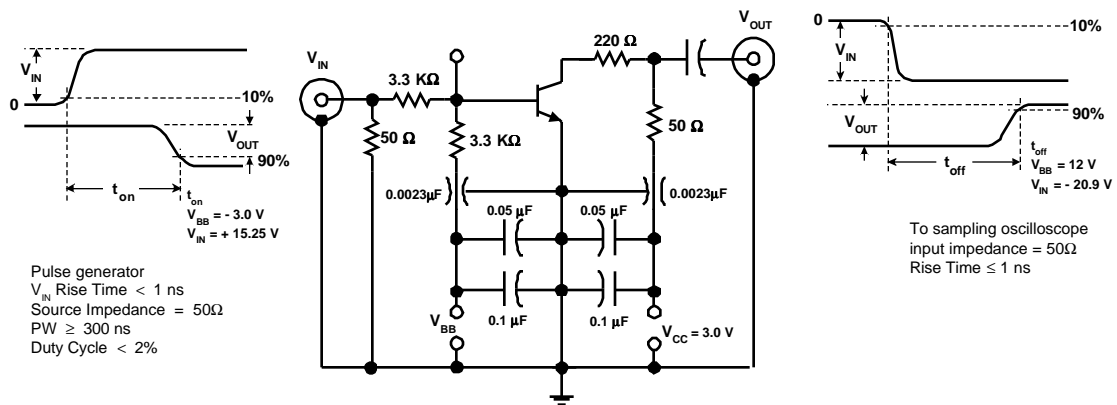

FIGURE 2: t_{ON} , t_{OFF} Measurement Circuit