

CQ92M, SCQ92M

- Polyester film/foil capacitor
- According to IEC 60384-11

TYPICAL APPLICATIONS

Coupling and decoupling.

CONSTRUCTION

Capacitor with polyester film and metal foil electrodes. Radial leads of tinned wire are electrically welded to the electrodes. Coated with epoxy resin.

TECHNICAL DATA

Rated voltage U_R, VDC		50	100	250
Rated voltage U_R, VAC		30	63	160
Capacitance, μF	CQ:	0.001 -0.47	0.001 -0.47	0.001 -0.1
	SCQ:	0.001 -0.47		
Capacitance tolerance		$\pm 10\%$, $\pm 5\%$		
Temperature range		-40 ... +85°C		
Climatic category		IEC 60068-1, 40/085/21 DIN 40040, GPD		
Test voltage		2.5 x U_R VDC for 2s		
Dissipation factor, $\tan\delta$		at +20°C: $\tan\delta \leq 0.8\%$ at 1 kHz.		
Insulation resistance		Measured at +20°C, according to IEC 60384-11.		
		Minimum values between terminals: 30 000 M Ω C \leq 0.33 μF 10 000 M Ω C > 0.33 μF		

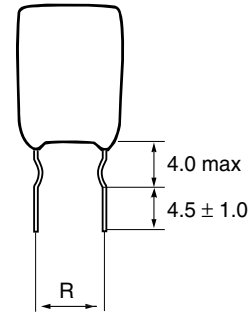
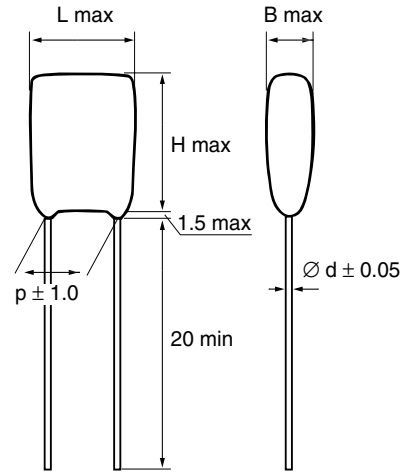

Lead diameter

SCQ92M:	d = 0.5 mm for C \leq 0.22 μF and d = 0.6 mm for C > 0.22 μF
CQ92M:	d = 0.5 mm for C \leq 0.12 μF and d = 0.6 mm for C > 0.12 μF

TYPICAL DATA

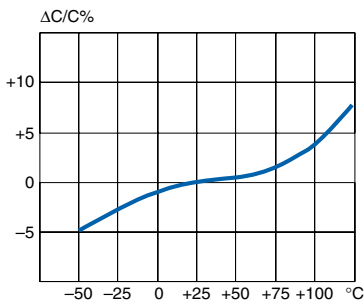

Capacitance vs.
temperature (at 1 kHz)

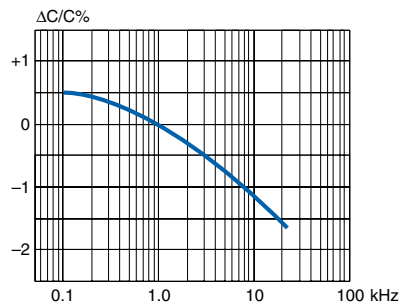

Capacitance vs.
frequency (at +23°C)

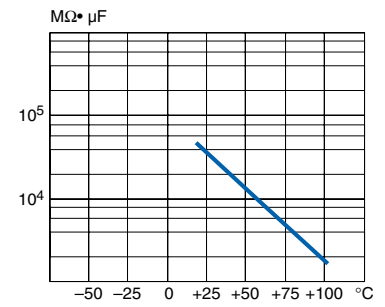

Insulation resistance vs.
temperature

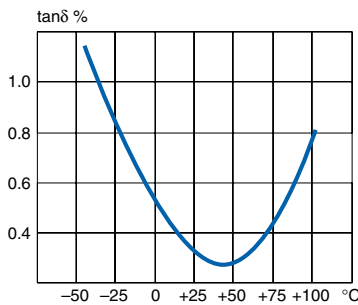

Dissipation factor vs.
temperature

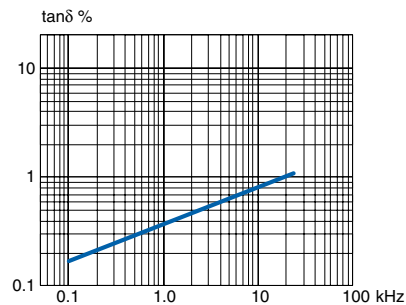

Dissipation factor vs.
frequency (at +23°C)

ENVIRONMENTAL TEST DATA

Damp heat test	Test conditions: Test criteria:	T = +40°C, RH = 93%, t = 21 days. Δ C/C ≤ 5%, tanδ after test ≤ 1.0% (1kHz) IR after test 9000 MΩ.
Endurance test	Test conditions: Test criteria:	T = +85°C, U = 1.4 × U _R , t = 1000 h. Δ C/C ≤ 5%, tanδ ≤ 1.0% (1kHz) IR after test 5000 MΩ.

ORDERING INFORMATION

See article table and pages 18 to 23 for options and article code construction.

MARKING

CQ92M

- Capacitance
- Tolerance
- Rated voltage

SCQ92M

- Capacitance
- Tolerance
- An underline under the tolerance indicates that the capacitor is rated 50V.

ARTICLE TABLE CQ92M

Capacitance μF	Max dimensions in mm					Quantity per package		Article code
	B	H	L	p	R	Bulk	Ammo	
50 VDC/30 VAC & 100VDC/63 VAC								
0.0010	3.0	11.0	5.6	3.5	5.0	1000	2000	CQ92M 102K100 TA16
0.0015	3.0	11.0	5.6	3.5	5.0	1000	2000	CQ92M 152K100 TA16
0.0022	3.0	11.0	5.6	3.5	5.0	1000	2000	CQ92M 222K100 TA16
0.0033	3.0	11.0	5.6	3.5	5.0	1000	2000	CQ92M 332K100 TA16
0.0047	3.0	11.0	5.6	3.5	5.0	1000	2000	CQ92M 472K100 TA16
0.0068	3.5	12.0	6.0	3.5	5.0	1000	2000	CQ92M 682K100 TA16
0.010	3.5	12.0	6.5	3.5	5.0	1000	2000	CQ92M 103K100 TA16
0.015	3.5	13.0	6.5	4.0	5.0	1000	2000	CQ92M 153K100 TA16
0.022	4.0	13.0	7.0	5.0	5.0	1000	2000	CQ92M 223K100 TA16
0.033	4.5	13.5	8.0	5.0	5.0	1000	2000	CQ92M 333K100 TA16
0.047	4.5	14.0	9.0	5.0	5.0	1000	1000	CQ92M 473K100 TA16
0.068	5.0	14.0	10.0	7.5	5.0	500	1000	CQ92M 683K100 TA16
0.10	6.0	14.0	11.0	7.5	5.0	500	1000	CQ92M 104K100 TA16
0.15	7.0	17.0	12.0	7.5	5.0	500		CQ92M 154K100
0.22	8.0	18.0	13.5	10.0	5.0	500		CQ92M 224K100
0.33	8.5	21.0	15.0	10.0	7.5	500		CQ92M 334K100
0.47	10.0	21.0	18.0	10.0	7.5	500		CQ92M 474K100

250 VDC/160 VAC

0.0010	3.5	12.0	6.0	3.5	5.0	1000	2000	CQ92M 102K250 TA16
0.0015	3.5	12.0	6.0	3.5	5.0	1000	2000	CQ92M 152K250 TA16
0.0022	3.5	12.0	6.0	3.5	5.0	1000	2000	CQ92M 222K250 TA16
0.0033	3.5	12.0	6.0	3.5	5.0	1000	2000	CQ92M 332K250 TA16
0.0047	3.5	12.0	6.0	3.5	5.0	1000	2000	CQ92M 472K250 TA16
0.0068	3.5	13.0	6.0	4.5	5.0	1000	2000	CQ92M 682K250 TA16
0.010	4.5	13.5	7.5	4.5	5.0	1000	2000	CQ92M 103K250 TA16
0.015	4.5	13.5	8.0	5.0	5.0	1000	2000	CQ92M 153K250 TA16
0.022	5.5	14.0	9.0	5.0	5.0	1000	2000	CQ92M 223K250 TA16
0.033	5.5	14.0	9.0	5.0	5.0	1000	1000	CQ92M 333K250 TA16
0.047	6.5	14.0	10.0	5.5	5.0	1000	1000	CQ92M 473K250 TA16
0.068	7.0	15.0	12.0	6.5	5.0	1000		CQ92M 683K250
0.10	8.0	15.0	13.0	7.5	5.0	1000		CQ92M 104K250

ARTICLE TABLE SCQ92M

Capacitance μF	Max dimensions in mm					Quantity per package		Article code
	B	H	L	p	R	Bulk	Ammo	
50 VDC/30 VAC								
0.0010	3.0	8.0	6.0	3.5	5.0	1000	2000	SCQ92M 102K50 TA16
0.0015	3.0	8.0	6.0	3.5	5.0	1000	2000	SCQ92M 152K50 TA16
0.0022	3.0	8.0	6.0	3.5	5.0	1000	2000	SCQ92M 222K50 TA16
0.0033	3.0	8.0	6.0	3.5	5.0	1000	2000	SCQ92M 332K50 TA16
0.0047	3.5	8.0	6.0	3.5	5.0	1000	2000	SCQ92M 472K50 TA16
0.0068	3.5	8.0	6.5	3.5	5.0	1000	2000	SCQ92M 682K50 TA16
0.010	3.5	8.0	6.5	3.5	5.0	1000	2000	SCQ92M 103K50 TA16
0.015	3.5	9.5	6.5	3.5	5.0	1000	2000	SCQ92M 153K50 TA16
0.022	5.0	10.0	6.5	3.5	5.0	1000	2000	SCQ92M 223K50 TA16
0.033	5.0	10.0	8.0	3.5	5.0	1000	2000	SCQ92M 333K50 TA16
0.047	5.0	10.5	8.0	5.0	5.0	1000	1000	SCQ92M 473K50 TA16
0.068	5.0	11.0	9.5	5.0	5.0	500	1000	SCQ92M 683K50 TA16
0.10	6.0	11.5	10.0	5.0	5.0	500	1000	SCQ92M 104K50 TA16
0.15	6.5	12.5	11.0	5.0	5.0	500	1000	SCQ92M 154K50 TA16
0.22	7.0	14.5	11.5	7.5	5.0	500	1000	SCQ92M 224K50 TA16
0.33	7.5	14.5	12.5	7.5	7.5	500		SCQ92M 334K50
0.47	8.5	15.0	14.5	7.5	7.5	500		SCQ92M 474K50