

Features

- Low idling current (20mA/2 channels)
- Output power 8.5W x 2 typ. ($R_L = 3\Omega$)
- High ripple rejection (60dB at steady state)
- Small pop noise at the time of power supply ON
- Thermal protector
- Adoption of SEP14H ($\Theta_{j-c} = 3^\circ\text{C/W}$) facilitates thermal design.

Maximum Ratings/ $T_a = 25^\circ\text{C}$

				unit
Maximum supply voltage	V_{CC} max		24	V
Allowable power dissipation	P_D max	With infinite heat sink	15	W
Maximum output current	I_O peak	1 channel	2.5	A
Operating temperature	T_{opr}		-20 to +75	$^\circ\text{C}$
Storage temperature	T_{stg}		-40 to +150	$^\circ\text{C}$

Operating Conditions/ $T_a = 25^\circ\text{C}$

				unit
Recommended supply voltage	V_{CC}		15	V
Operating voltage range	V_{CC}^*	P_D max must not be exceeded.	9 to 23	V
Recommended load resistance	R_L	2 channels	3	Ω

Operating Characteristics/ $T_a = 25^\circ\text{C}$, $V_{CC} = 15\text{V}$, $R_L = 3\Omega$ (2 channels), $f = 1\text{kHz}$, $R_g = 600\Omega$, See specified test circuit.

			min	typ	max	unit
Quiescent current	I_{CCO}	2 channels	10	20	30	mA
Voltage gain	VG		42	44	46	dB
Voltage gain difference	ΔVG	ch1, ch2			± 1	dB
Output power	P_O	THD = 10%	7.5	8.5		W
Total harmonic distortion	THD	$V_O = 2\text{V}$		0.15	1.0	%
Input resistance	r_i			30k		Ω
Output noise voltage	V_{NO1}	$R_g = 0$, $f = 20\text{Hz}$ to 20kHz , B.P.F		0.2	0.5	mV
	V_{NO2}	$R_g = 10\text{k}\Omega$, $f = 20\text{Hz}$ to 20kHz , B.P.F		0.3	1.0	mV
Ripple rejection	R_r		45	60		dB
Channel separation	ch sep		45	55		dB

Package Dimensions 3023A-S14HIC (unit: mm)

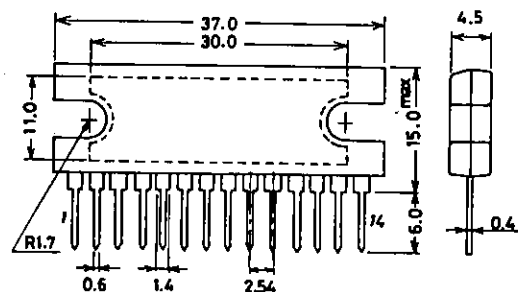

SANYO: SEP14H

Equivalent Circuit

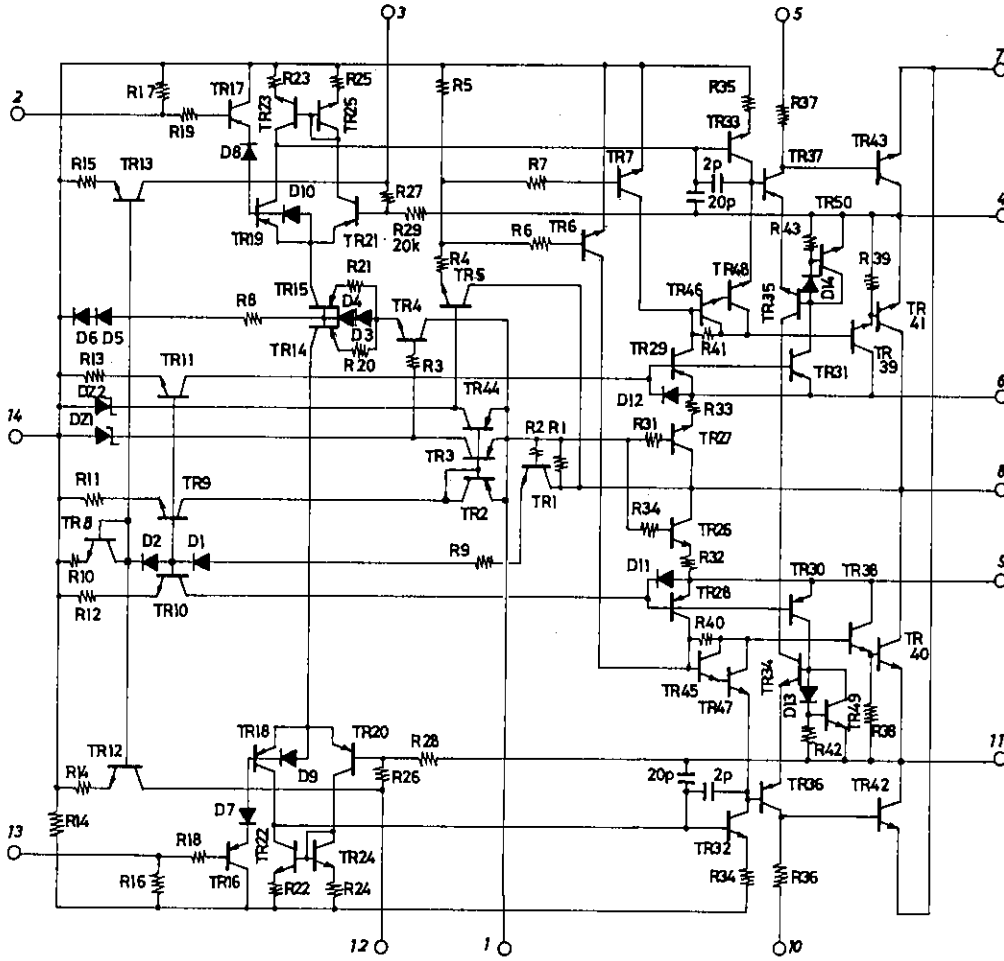

Unit (resistance: Ω , capacitance: F)

Sample Application Circuit

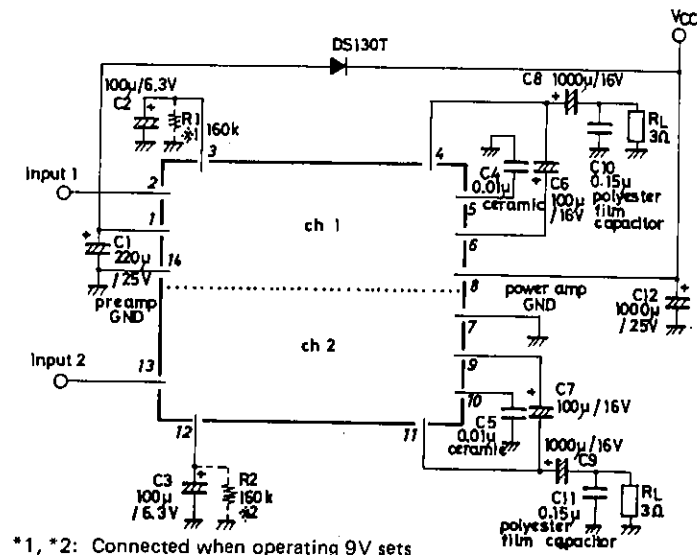

Sample Printed Circuit Pattern (Cu-foiled area)

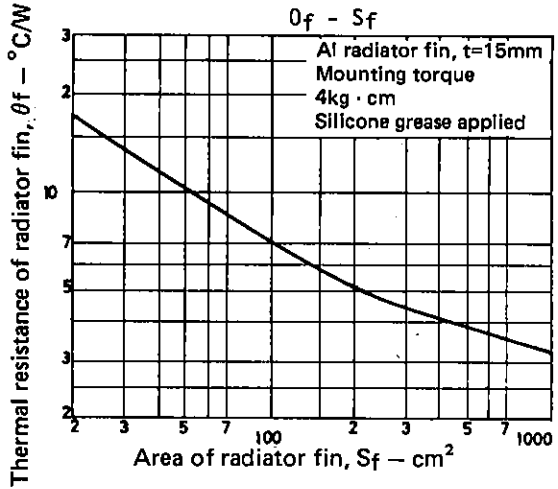
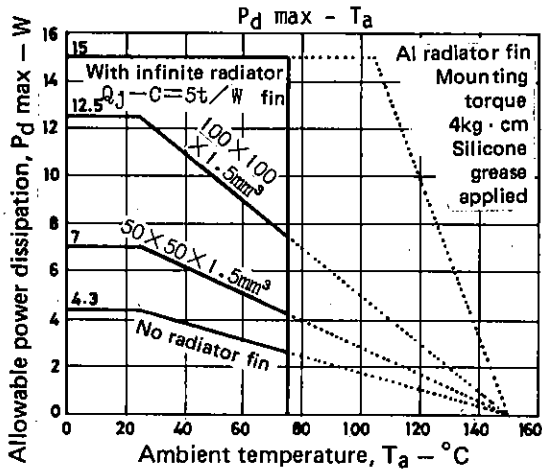
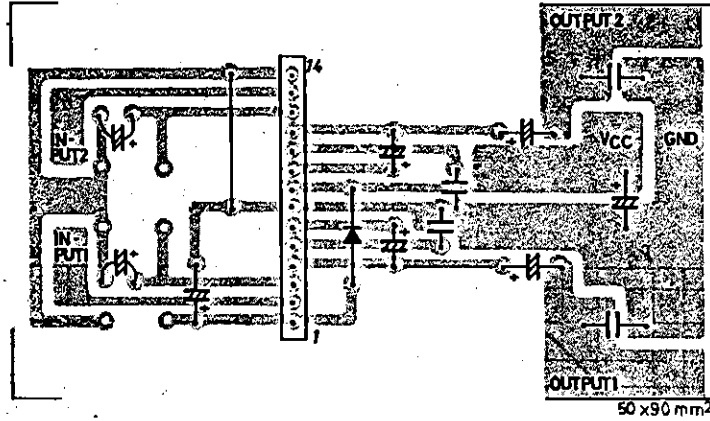

Description of external parts

- C₁:** Decoupling capacitor
Used for the ripple filter. Since the rejection effect is saturated at a certain capacity, it is meaningless to increase the capacity more than needed. This capacitor, being also used for the time constant of the pop noise preventer, affects the starting time. Too small a capacity makes the pop noise level higher. (Recommended value: 100 μ F to 330 μ F)
- C₂ (C₃):** Feedback capacitor
Since the low cutoff frequency depends on this feedback capacitor, the required bandwidth must be considered before determining the value of this feedback capacitor. This feedback capacitor also affects the starting time.
- C₄ (C₅):** Switching distortion suppressing capacitor
Used to suppress switching distortion which often appears at high frequencies in overinput mode. The recommended value is 0.01 μ F (ceramic capacitor).
- C₆ (C₇):** Bootstrap capacitor
The output at low frequencies depends on this capacitor. If the capacity is decreased, the output at low frequencies goes lower. 47 μ F min. is required. (This, however, does not apply if load R_L is light.)
- C₈ (C₉):** Output capacitor
The low cutoff frequency depends on this output capacitor. (Refer to the characteristic graph.)
- C₁₀ (C₁₁):** Oscillation blocking capacitor
Polyester film capacitor, being excellent in temperature characteristic, frequency characteristic, is used. The use of an aluminum electrolytic capacitor or ceramic capacitor may cause oscillation to occur at low temperatures.
- C₁₂:** Power source capacitor
This power source capacitor must accommodate loads (motor, etc.) in the power line or ripple in the transformer output. The recommended value is 1000 μ F to 2200 μ F.

- R₁ (R₂):** Normally, this resistor is not required. If the IC is used at V_{CC} = 9V or thereabouts, clip balance may be disturbed. This resistor can be used to correct such disturbance.
- D₁:** When a motor is started, or in similar modes, the supply voltage drops abruptly, causing the filter transistor to be saturated. This diode is a bypass diode and can be used to prevent such saturation from occurring. Whether or not to use this diode depends on the set to be made.

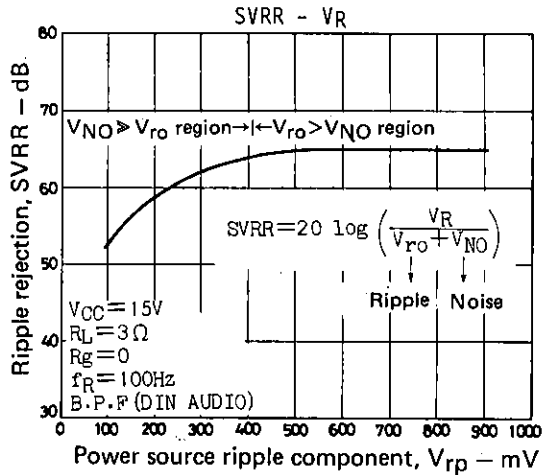
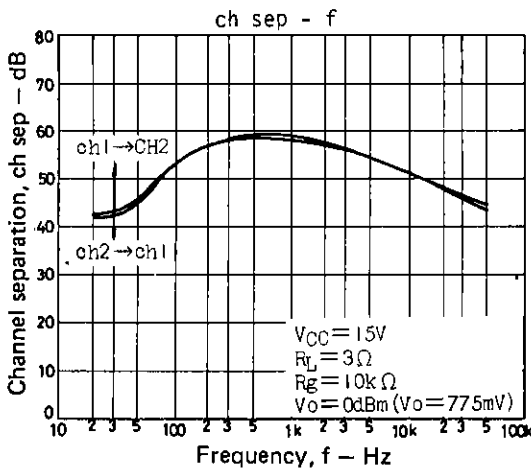
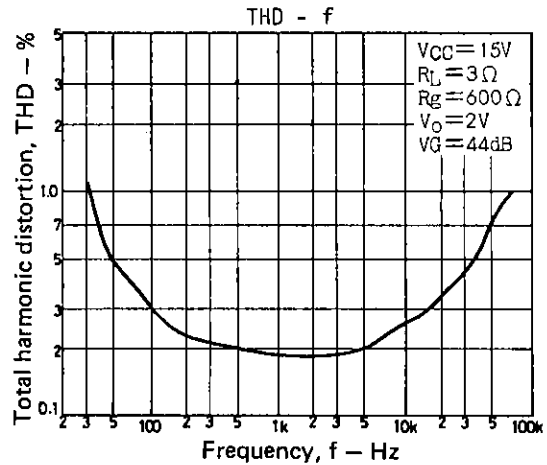
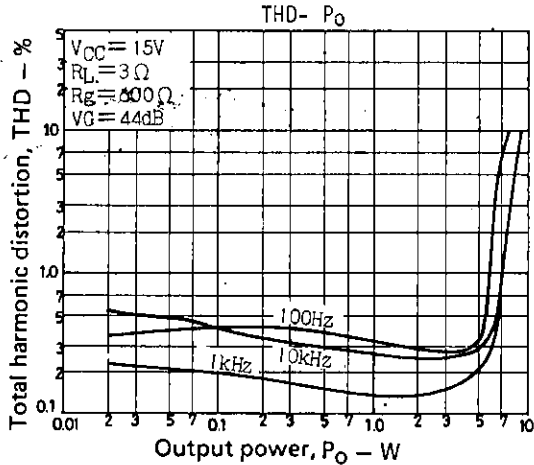
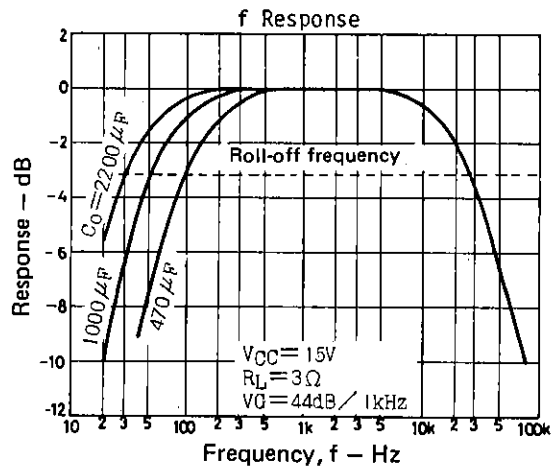
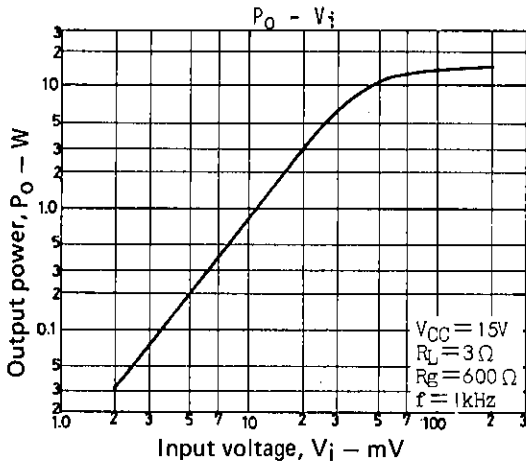

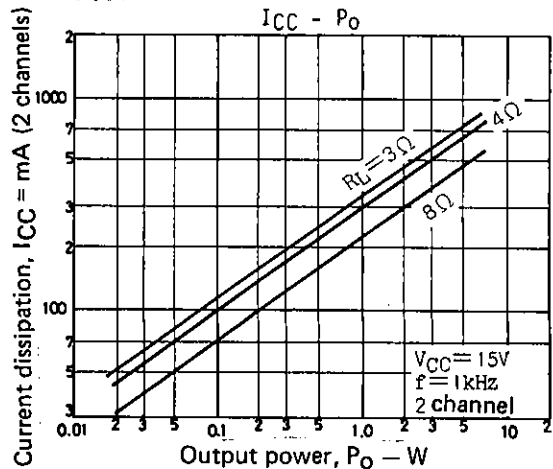
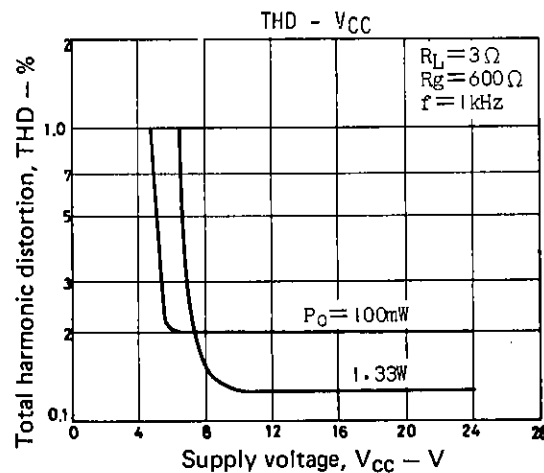
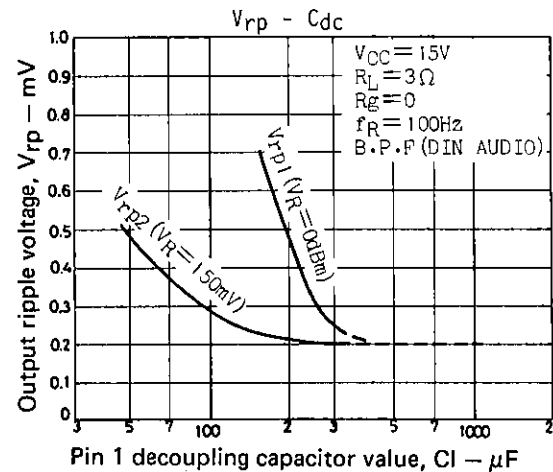
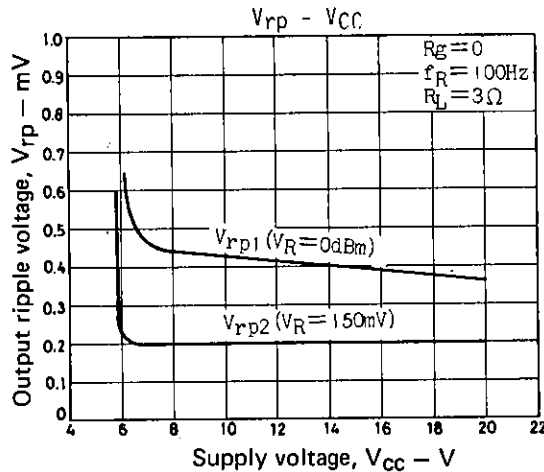
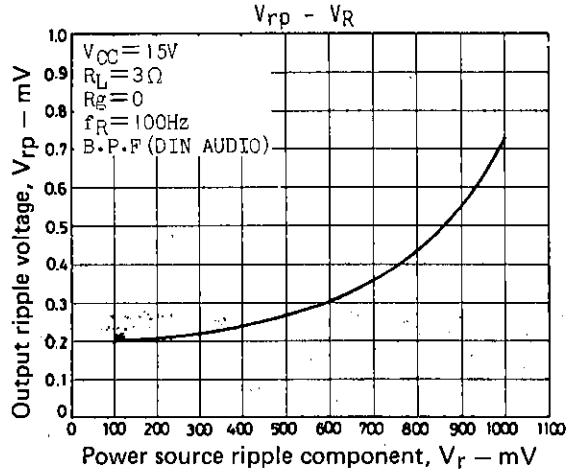
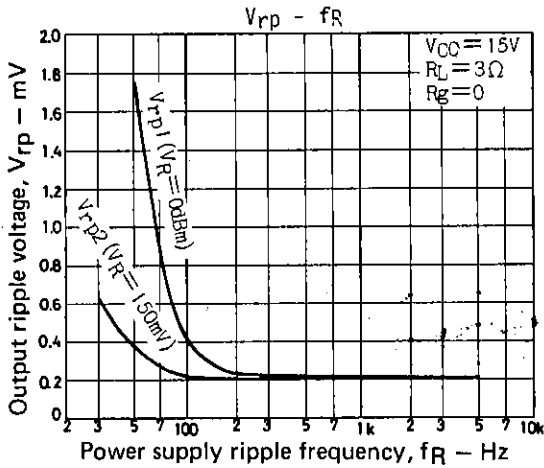
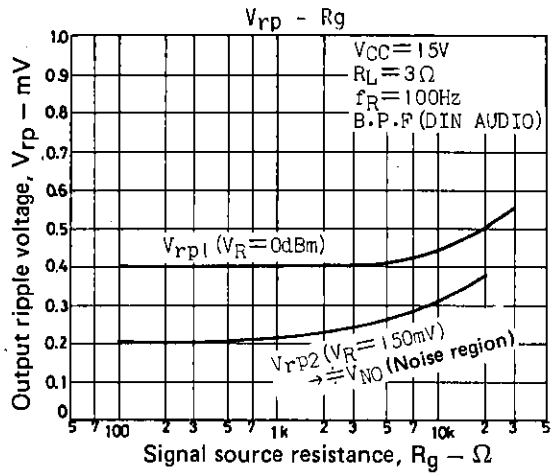
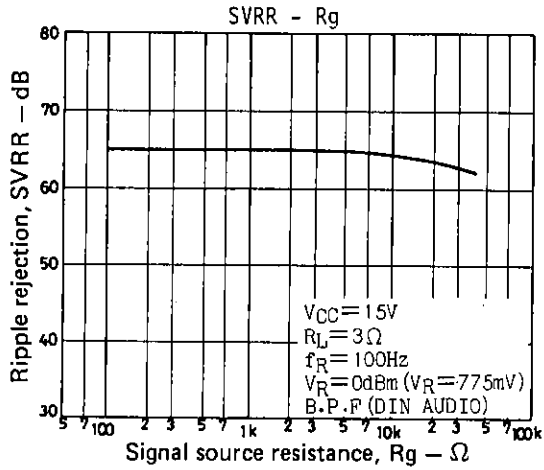

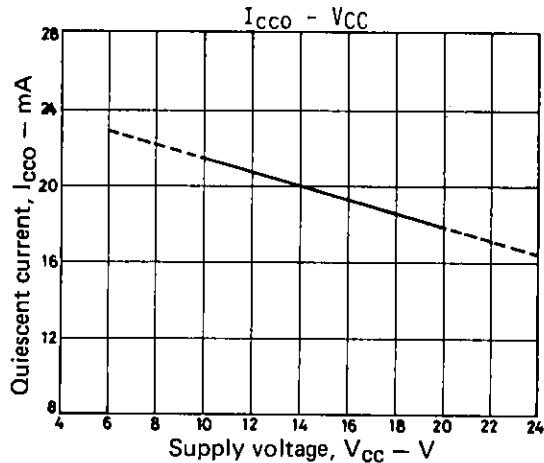
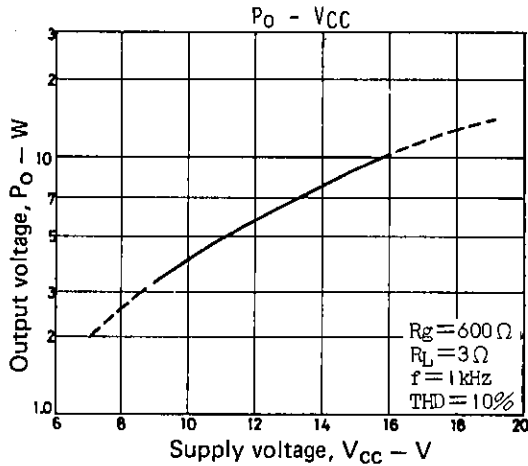
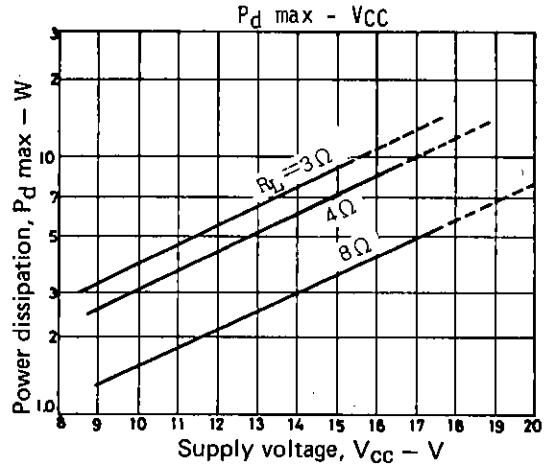
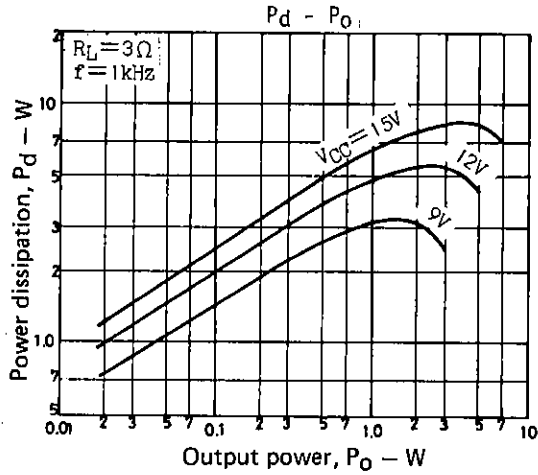

Proper cares in using IC

1. If the IC is used in the vicinity of the maximum rating, even a slight variation in conditions may cause the maximum rating to be exceeded, thereby leading to breakdown. Allow an ample margin of variation for supply voltage, etc. and use the IC in the range where the maximum rating is not exceeded.
2. Pin-to-pin short, inverted insertion
If supply voltage is applied when the space between pins is shorted, breakdown or deterioration may occur. When mounting the IC on the board or applying supply voltage, make sure that the space between pins is not shorted with solder, etc. If the IC is inserted inversely, it may be broken down momentarily because of pin 7: Power Gnd, pin 8: V_{CC} .
3. Load short
If the IC is used with the load shorted for a long time, breakdown or deterioration may occur. Be sure not to short the load.
4. Change in closed-loop gain
By connecting R_{NF} in series with pins 3, 12 (NF pin), the gain can be reduced, but the following must be noted.
 - a. If R_{NF} is connected, the ripple bypass effect brought about by the NF capacitor is lessened, leading to insufficient ripple rejection.
 - b. Do not operate at 40dB or less so that stable oscillation is maintained.
5. When the IC is used in radios or radio-cassette tape recorders, keep a good distance between IC and bar antenna. A capacitor of $0.022\mu\text{F}$ or more (polyester film capacitor) connected between pins 9 and 7 and between pins 6 and 7 acts effectively against radiation to the SW band.
6. Printed circuit board
When making the board, refer to the sample printed circuit pattern. No feedback loop must be formed between input and output and make the line thick and short so that no common resistor exists between pre-GND and power-GND.

Continued on next page.

Continued from preceding page.

7. Some plug jacks to be used for connecting to the external speaker are such that both poles are short-circuited once when connecting. In this case, the load is short-circuited, which may break down the IC.
8. Improvement in reduced voltage characteristic (Reference example).
By connecting parts as shown below, distortion-free operation can be performed at a supply voltage down to $V_{CC} = 4.5V$ or thereabouts. The capacitor of $100\mu F$ is connected to suppress pop noise.

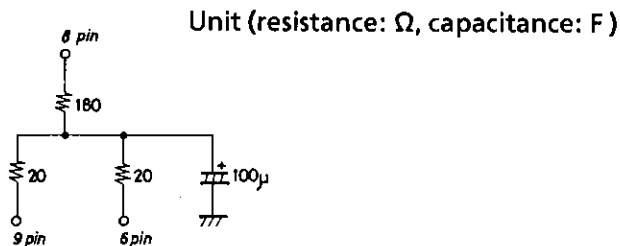

Proper cares in mounting radiator fin

1. The mounting torque is in the range of 4 to 6kg.cm.
2. The distance between screw holes of the radiator fin must coincide with the distance between screw holes of the IC. With case outline dimensions L and R referred to, the screws must be tightened with the distance between them as close to each other as possible.

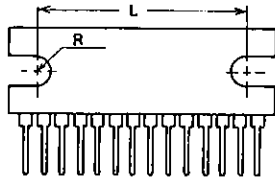

3. The screw to be used must have a head equivalent to the truss machine screw or binder machine screw defined by JIS. Washers must be also used to protect the IC case.
4. No foreign matter such as cutting particles shall exist between heat sink and radiator fin. When applying grease on the junction surface, it must be applied uniformly on the whole surface.
5. IC lead pins are soldered to the printed circuit board after the radiator fin is mounted on the IC.

- No products described or contained herein are intended for use in surgical implants, life-support systems, aerospace equipment, nuclear power control systems, vehicles, disaster/crime-prevention equipment and the like, the failure of which may directly or indirectly cause injury, death or property loss.
- Anyone purchasing any products described or contained herein for an above-mentioned use shall:
 - ① Accept full responsibility and indemnify and defend SANYO ELECTRIC CO., LTD., its affiliates, subsidiaries and distributors and all their officers and employees, jointly and severally, against any and all claims and litigation and all damages, cost and expenses associated with such use:
 - ② Not impose any responsibility for any fault or negligence which may be cited in any such claim or litigation on SANYO ELECTRIC CO., LTD., its affiliates, subsidiaries and distributors or any of their officers and employees jointly or severally.
- Information (including circuit diagrams and circuit parameters) herein is for example only; it is not guaranteed for volume production. SANYO believes information herein is accurate and reliable, but no guarantees are made or implied regarding its use or any infringements of intellectual property rights or other rights of third parties.