

PC733

AC Input Type Photocoupler

※ Lead forming type (I type) is also available. (PC733I)

■ Features

1. AC input response
2. High isolation voltage between input and output ($V_{iso} : 5\,000V_{rms}$)
3. Current transfer ratio
CTR : MIN. 15% at $I_F = \pm 1mA$, $V_{CE} = 5V$
4. Low collector dark current
($I_{CEO} : MAX. 10^{-7}A$ at $V_{CE} = 20V$)
5. TTL compatible output
6. Recognized by UL, file No. E64380

■ Applications

1. Telephone sets
2. Programmable controllers
3. System appliances, measuring instruments
4. Signal transmission between circuits of different potentials and impedances

■ Outline Dimensions

(Unit : mm)

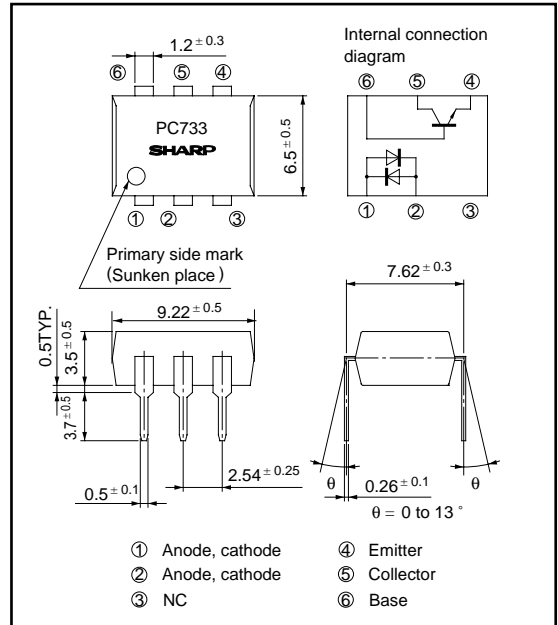

■ Absolute Maximum Ratings

($T_a = 25^\circ C$)

Parameter		Symbol	Rating	Unit
Input	Forward current	I_F	± 50	mA
	*1 Peak forward current	I_{FM}	± 1	A
	Power dissipation	P	70	mW
Output	Collector-emitter voltage	V_{CEO}	35	V
	Emitter-collector voltage	V_{ECO}	6	V
	Collector-base voltage	V_{CBO}	35	V
	Emitter-base voltage	V_{EBO}	6	V
	Collector current	I_C	50	mA
	Collector power dissipation	P_C	150	mW
	Total power dissipation	P_{tot}	170	mW
*2 Isolation voltage	V_{iso}	5 000	Vrms	
Operating temperature	T_{opr}	- 25 to + 100	$^\circ C$	
Storage temperature	T_{stg}	- 40 to + 125	$^\circ C$	
*3 Soldering temperature	T_{sol}	260	$^\circ C$	

*1 Pulse width $\leq 100\mu s$, Duty ratio : 0.001

*2 40 to 60% RH, AC for 1 minute

*3 For 10 seconds

Electro-optical Characteristics

($T_a = 25^\circ\text{C}$)

Parameter		Symbol	Conditions	MIN.	TYP.	MAX.	Unit	
Input	Forward voltage	V_F	$I_F = \pm 20\text{mA}$	-	1.2	1.4	V	
	Peak forward voltage	V_{FM}	$I_{FM} = \pm 0.5\text{A}$	-	-	3.0	V	
	Terminal capacitance	C_t	$V = 0, f = 1\text{kHz}$	-	50	400	pF	
Output	Collector dark current	I_{CEO}	$V_{CE} = 20\text{V}, I_F = 0$	-	-	10^{-7}	A	
Transfer characteristics	Current transfer ratio	CTR	$I_F = \pm 1\text{mA}, V_{CE} = 5\text{V}$	15	-	300	%	
	Collector-emitter saturation voltage	$V_{CE(sat)}$	$I_F = \pm 20\text{mA}, I_C = 1\text{mA}$	-	0.1	0.2	V	
	Isolation resistance	R_{ISO}	DC500V, 40 to 60% RH	5×10^{10}	10^{11}	-	Ω	
	Floating capacitance	C_f	$V = 0, f = 1\text{MHz}$	-	0.6	1.0	pF	
	Cut-off frequency	Response time	f_c	$V_{CE} = 5\text{V}, I_C = 2\text{mA}, R_L = 100\Omega, -3\text{dB}$	15	80	-	kHz
					t_r	t_f	$V_{CE} = 2\text{V}, I_C = 2\text{mA}$	-
$R_L = 100\Omega$	-	3	18	μs				

Fig. 1 Forward Current vs. Ambient Temperature

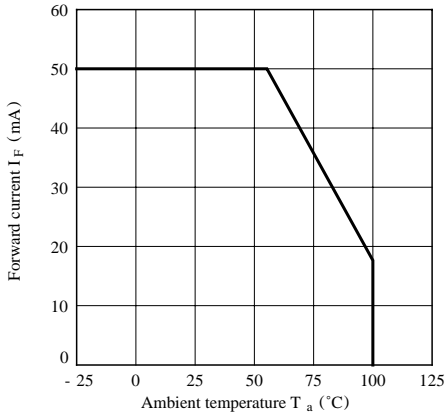

Fig. 2 Diode Power Dissipation vs. Ambient Temperature

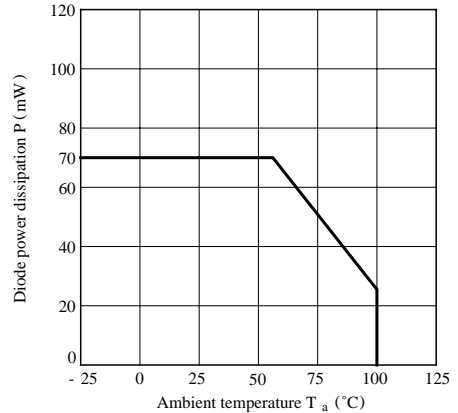

Fig. 3 Collector Power Dissipation vs. Ambient Temperature

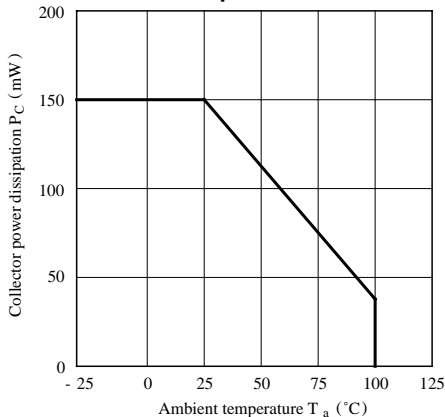

Fig. 4 Power Dissipation vs. Ambient Temperature

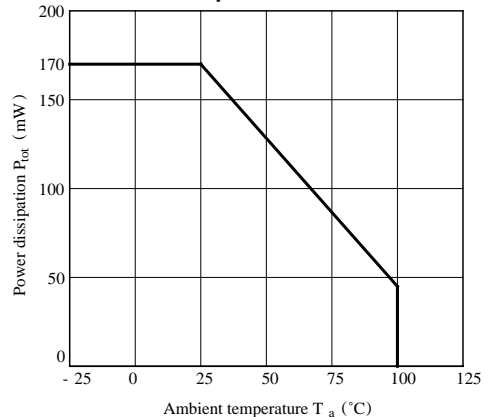

Fig. 5 Peak Forward Current vs. Duty Ratio

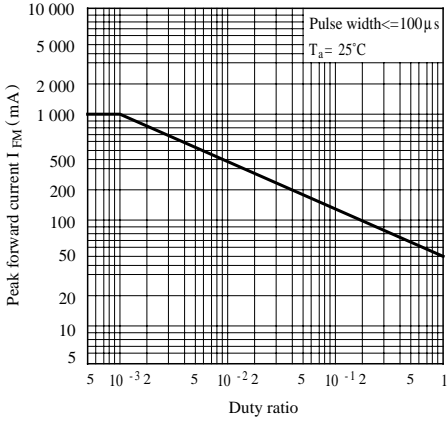

Fig. 6 Forward Current vs. Forward Voltage

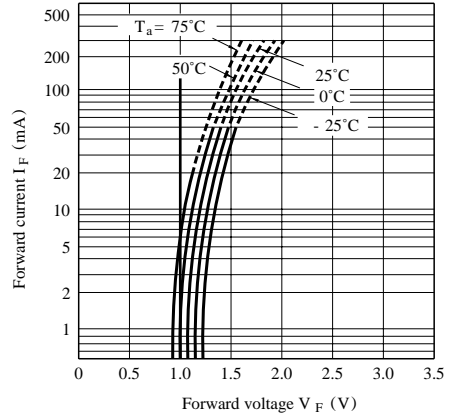

Fig. 7 Current Transfer Ratio vs. Forward Current

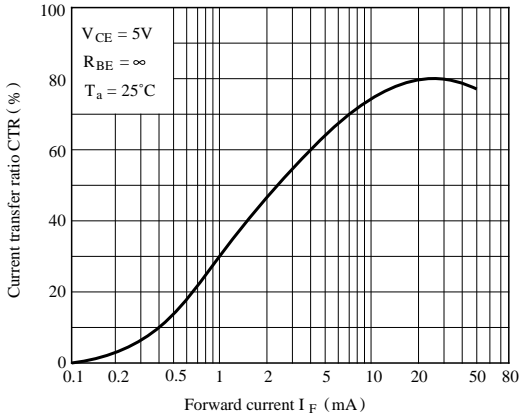

Fig. 8 Collector Current vs. Collector-emitter Voltage

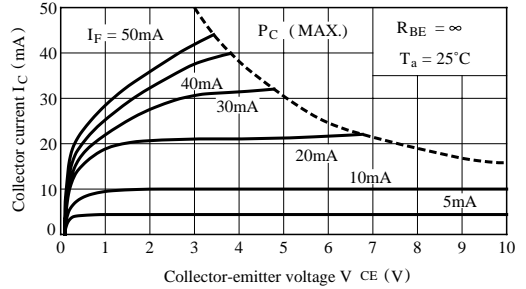

Fig. 9 Relative Current Transfer Ratio vs. Ambient Temperature

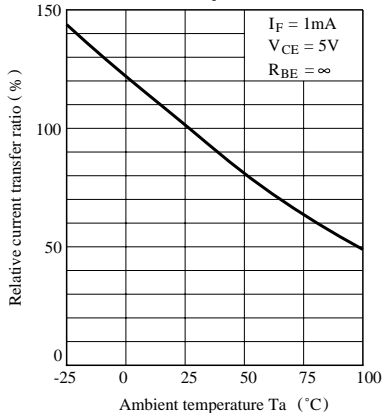

Fig.10 Collector-emitter Saturation Voltage vs. Ambient Temperature

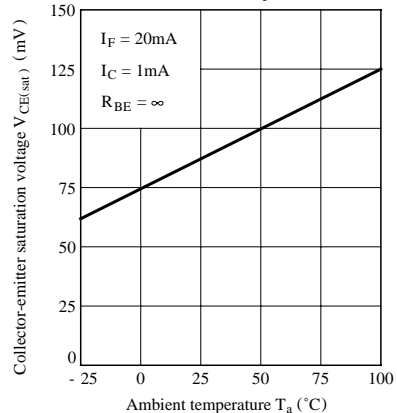

Fig.11-a Collector Dark Current vs. Ambient Temperature

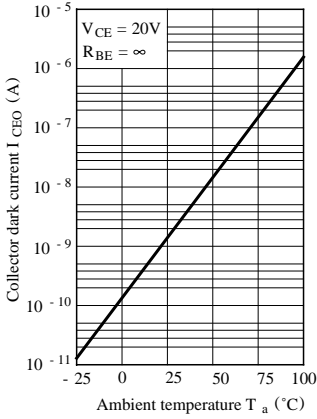

Fig.11-b Collector-base Dark Current vs. Ambient Temperature

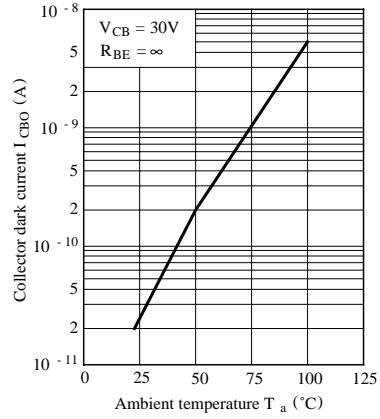

Fig.12 Response Time vs. Load Resistance

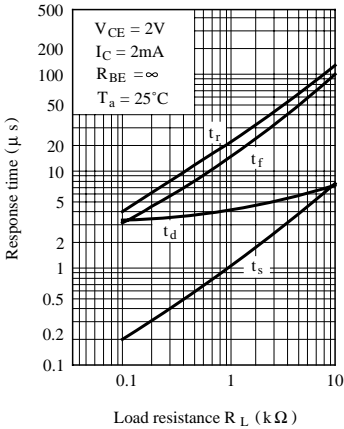
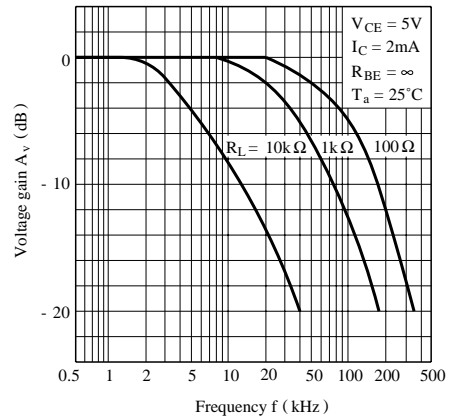
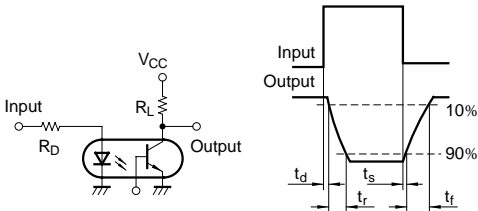

Fig.13 Frequency Response



Test Circuit for Response Time



Test Circuit for Frequency Response

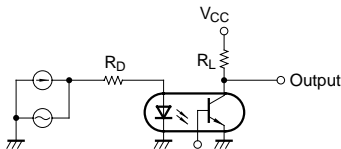

Fig.14 Collector-emitter Saturation Voltage vs. Forward Current

