

General Description

Utilizing Analogic Tech's state-of-the-art TrenchDMOS[®] process, the AHK6030L sets a new standard in current handling capability and efficiency for surface mount power MOSFETs.

Gate charge and $R_{DS(ON)}$ have been optimized and package inductance minimized to provide high efficiency for DC-DC converters.

Applications

- DC-DC converters for CPU's
- High Current Load Switch

Features

PWMSwitch™

- $V_{DS(MAX)} = 30V$
- $I_{D(MAX)}^{(a)} = 44 A @ 25^{\circ}C$
- $I_{APP(MAX)} = 17A$ in typical computer application
- Low Gate Charge
- Low $R_{DS(ON)}$:
 13.5 mΩ (max), 9.5 mΩ (typ) @ $V_{GS} = 10V$
 20 mΩ (max), 14 mΩ (typ) @ $V_{GS} = 4.5V$

DPAK-L Package

DPAK Package

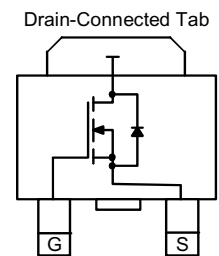
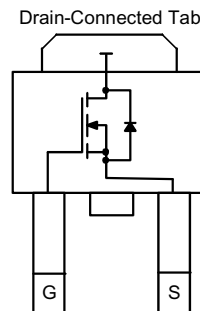

Absolute Maximum Ratings (T_A=25°C unless otherwise noted)

Symbol	Description	Value	Units	
V_{DS}	Drain-Source Voltage	30	V	
V_{GS}	Gate-Source Voltage	±20		
I_D	Continuous Drain Current @ T _J =150°C ^(a)	±44	A	
I_{DM}	Pulsed Drain Current ^(a)	±52		
I_S	Continuous Source Current (Source-Drain Diode) ^(a)	23		
P_D	Maximum Power Dissipation ^(a)	T _A = 25°C	39	W
		T _A = 70°C	25	
T _J , T _{STG}	Operating Junction and Storage Temperature Range	-55 to 150	°C	

Thermal Resistance			
$R_{\theta JA}$	Maximum Junction-to-Ambient ^(a)	96	°C/W
$R_{\theta JC}$	Maximum Junction-to-Case ^(a)	3.2	°C/W

Advanced Analogic Technologies, Inc.

1250 Oakmead Pkwy, Suite 310, Sunnyvale, CA 94086
 (408)524-9684 Fax (408)524-9689

Electrical Characteristics (T_J=25°C unless otherwise noted)

Symbol	Description	Conditions	Min	Typ	Max	Units
DC Characteristics						
B _{VDS}	Drain-Source Breakdown Voltage	V _{GS} =0V, I _D =250μA	30			V
R _{DS(ON)}	Drain-Source ON-Resistance	V _{GS} =10V, I _D =10A		9.5	13.5	mΩ
		V _{GS} =4.5V, I _D =5A		14	20	
I _{D(ON)}	On-State Drain Current	V _{GS} =10V, V _{DS} =5V (Pulsed)	56			A
V _{GS(th)}	Gate Threshold Voltage	V _{GS} =V _{DS} , I _D =250μA	1.0			V
I _{GSS}	Gate-Body Leakage Current	V _{GS} =±20V, V _{DS} =0V			±100	nA
I _{DSS}	Drain Source Leakage Current	V _{GS} =0V, V _{DS} =30V			1	μA
		V _{GS} =0V, V _{DS} =30V, T _A =70°C			25	
g _{fs}	Forward Transconductance	V _{DS} =15V, I _D =10A		19		S
Dynamic Characteristics						
Q _G	Total Gate Charge	V _{DS} =15V, I _D =15A, V _{GS} =10V		36	52	nC
Q _{GS}	Gate-Source Charge			7		nC
Q _{GD}	Gate-Drain Charge			6		nC
t _{D(ON)}	Turn-ON Delay	V _{DD} =15V, V _{GS} =10V, I _D =15A, R _G =6Ω		17	30	ns
t _R	Turn-ON Rise Time			11	20	ns
t _{D(OFF)}	Turn-OFF Delay			48	80	ns
t _F	Turn-OFF Fall Time			36	64	ns
Source-Drain Diode Characteristics						
V _{SD}	Source-Drain Forward Voltage	V _{GS} =0, I _S =28A		1	1.5	V
I _S	Continuous Diode Current				23	A

Notes:

- (a) Based on thermal dissipation from junction to case. R_{θJC} + R_{θCA} = R_{θJA} where the case thermal reference is defined as the solder mounting surface of the drain pins. R_{θJC} is guaranteed by design, however R_{θCA} is determined by the PCB design. Package current is limited to 26A DC.
- (b) With minimum copper pads on 1 x 1 inch FR4 board.

Typical Characteristics

Output Characteristics

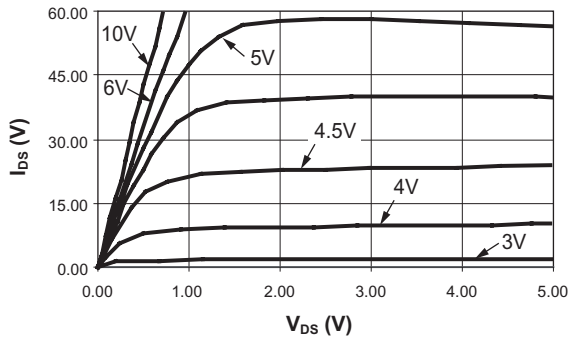

Transfer Characteristics

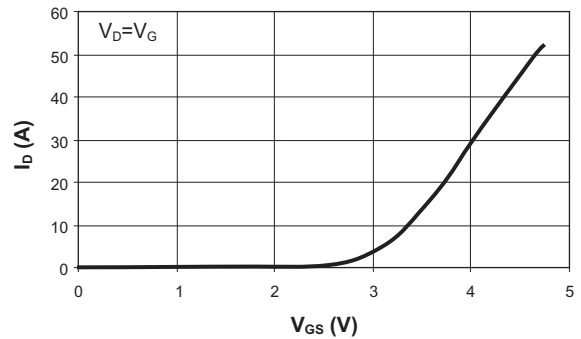

Normalized On-Resistance vs. Drain Current

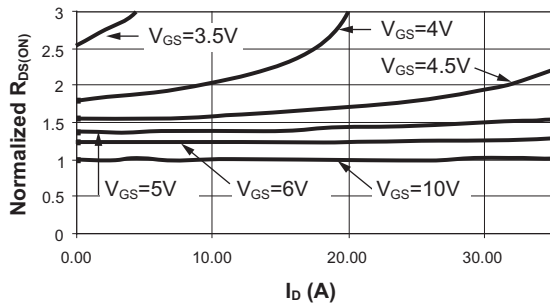

On-Resistance vs. Gate to Source Voltage

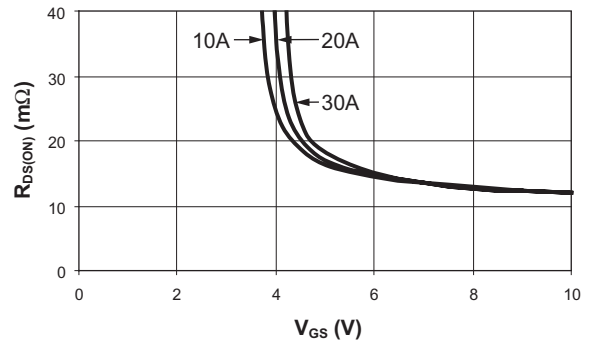

Gate Charge

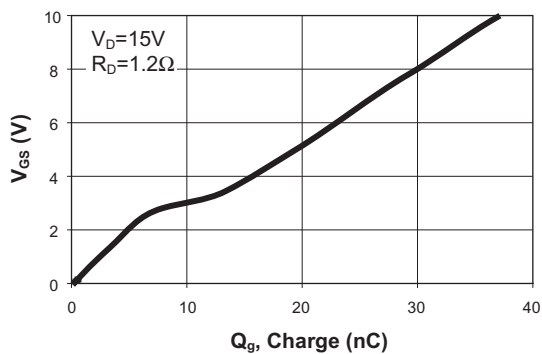

Source-Drain Diode Forward Voltage

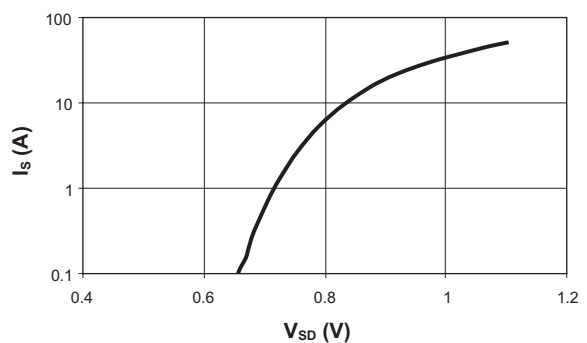

Ordering Information

Package	Marking	Part Number			
		Bulk	MPQ	Tape and Reel	MPQ
TO-252 (DPAK)	6030L	N/A	N/A	AHK6030LINY-T1	2100

Package Information

TO-252 (DPAK)

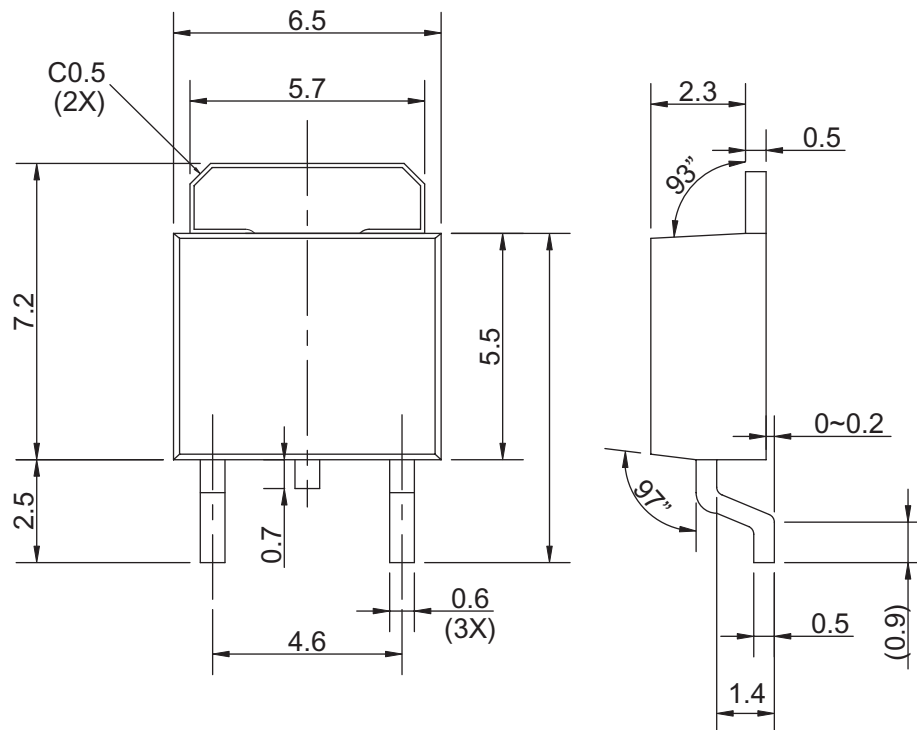

Advanced Analogic Technologies, Inc.

1250 Oakmead Pkwy, Suite 310, Sunnyvale, CA 94086
 (408)524-9684 Fax (408)524-9689