

HIGH CURRENT SWITCHING APPLICATION.
INTERFACE CIRCUIT AND DRIVER CIRCUIT APPLICATION.

FEATURES

- With Built-in Bias Resistors.
- Simplify Circuit Design.
- Reduce a Quantity of Parts and Manufacturing Process.
- High Output Current : 800mA.

EQUIVALENT CIRCUIT

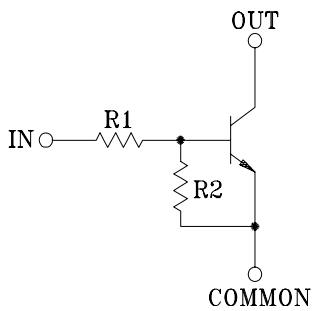

TYPE NO.	R1(kΩ)	R2(kΩ)
KRC241S	1	1
KRC242S	2.2	2.2
KRC243S	4.7	4.7
KRC244S	10	10
KRC245S	1	10
KRC246S	2.2	10

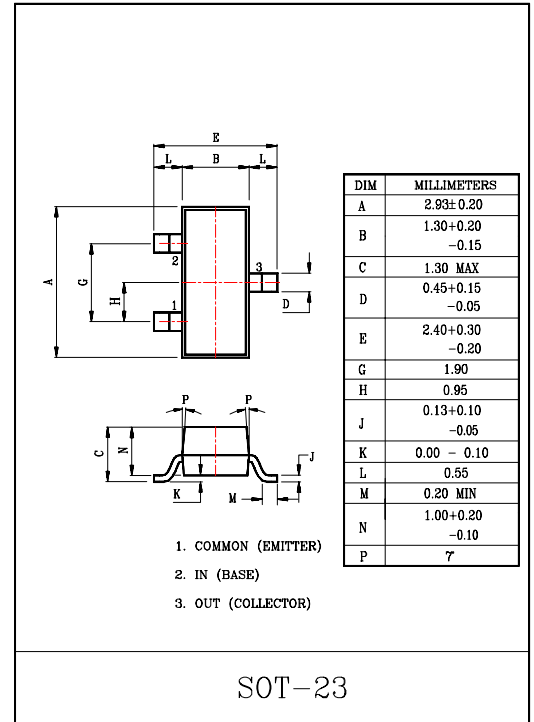

MAXIMUM RATINGS(Ta=25°C)

CHARACTERISTIC		SYMBOL	RATING	UNIT
Output Voltage	KRC241S ~ 246S	V _O	50	V
Input Voltage	KRC241S	V _I	10, -10	V
	KRC242S		12, -10	
	KRC243S		20, -10	
	KRC244S		30, -10	
	KRC245S		10, -5	
	KRC246S		12, -6	
Output Current	KRC241S ~ 246S	I _O	800	mA
Power Dissipation		P _D	200	mW
Junction Temperature		T _j	150	°C
Storage Temperature Range		T _{stg}	-55~150	°C

MARK SPEC

TYPE	KRC241S	KRC242S	KRC243S	KRC244S	KRC245S	KRC246S
MARK	NQ	NR	NS	NT	NU	NV

Marking

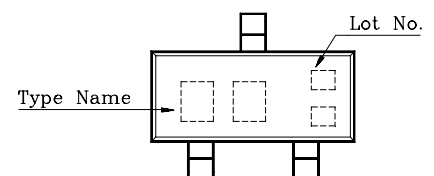

KRC241S ~ KRC246S

ELECTRICAL CHARACTERISTICS (T_a=25°C)

CHARACTERISTIC		SYMBOL	TEST CONDITION	MIN.	TYP.	MAX.	UNIT
Output Cut-off Current	KRC241S~246S	I _{O(OFF)}	V _O =30V, V _I =0	-	-	10	μA
DC Current Gain	KRC241S	G _I	V _O =5V, I _O =50mA	33	-	-	
	KRC242S			39	-	-	
	KRC243S			47	-	-	
	KRC244S			56	-	-	
	KRC245S			56	-	-	
	KRC246S			56	-	-	
Output Voltage	KRC241S~246S	V _{O(ON)}	I _O =50mA, I _I =2.5mA	-	0.1	0.3	V
Input Voltage (ON)	KRC241S	V _{I(ON)}	V _O =0.3V, I _O =20mA	-	-	3.0	V
	KRC242S			-	-	3.0	
	KRC243S			-	-	3.0	
	KRC244S			-	-	3.0	
	KRC245S			-	-	3.0	
	KRC246S			-	-	2.0	
Input Voltage (OFF)	KRC241S~244S	V _{I(OFF)}	V _O =5V, I _O =0.1mA	0.5	-	-	V
	KRC245S~246S			0.3	-	-	
Transition Frequency	KRC241S~246S	f _T *	V _O =10V, I _O =5mA, f=100MHz	-	200	-	MHz
Input Current	KRC241S	I _I	V _I = 5V	-	-	7.2	mA
	KRC242S			-	-	3.8	
	KRC243S			-	-	1.8	
	KRC244S			-	-	0.88	
	KRC245S			-	-	7.2	
	KRC246S			-	-	3.6	

Note : *Characteristic of Transistor Only

KRC241S ~ KRC246S

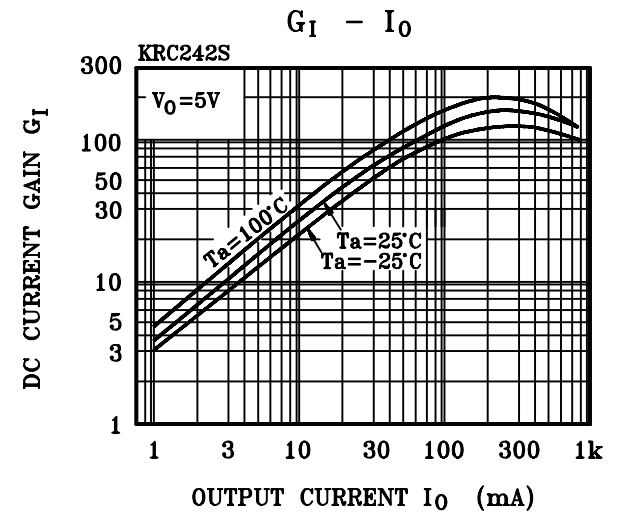
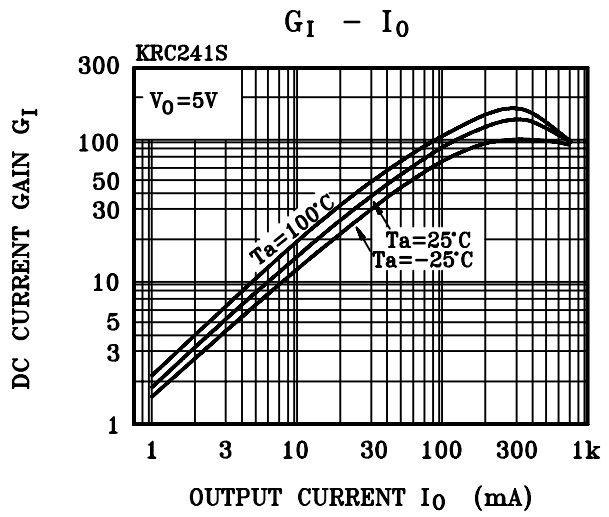
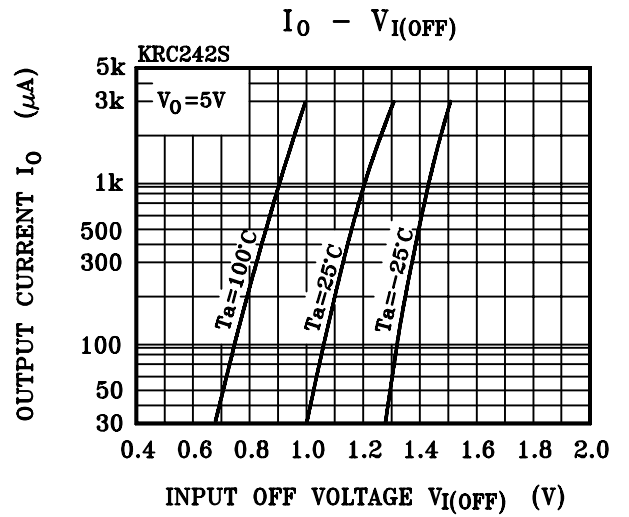
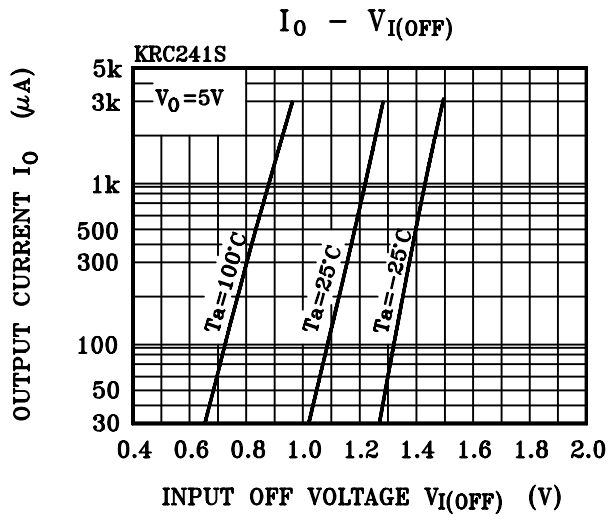
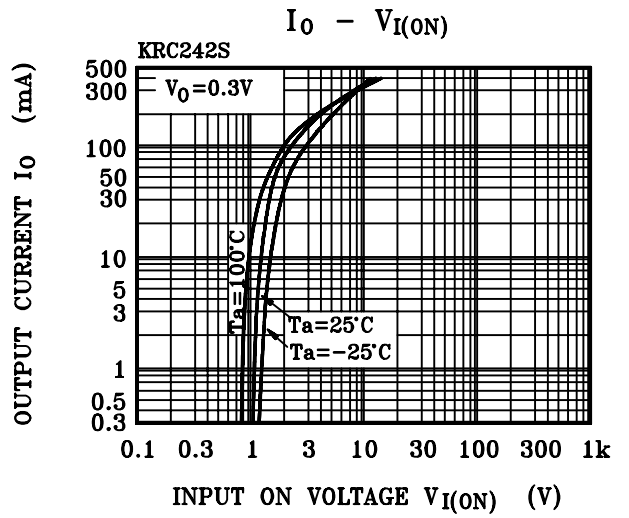
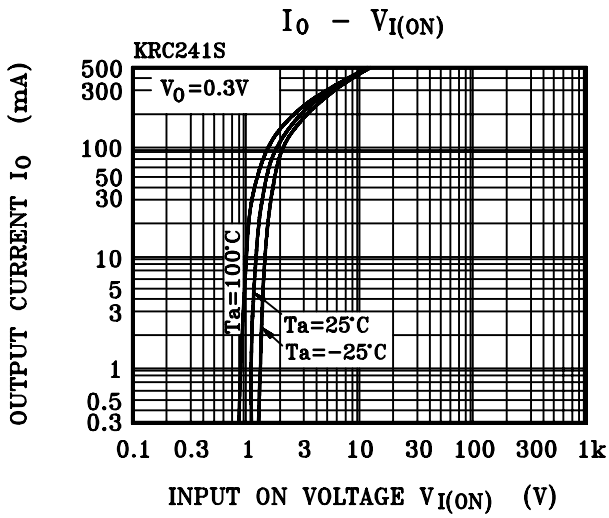

KRC241S ~ KRC246S

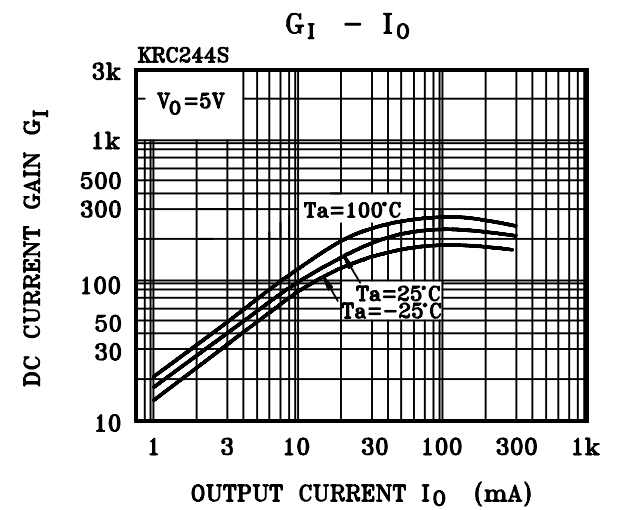
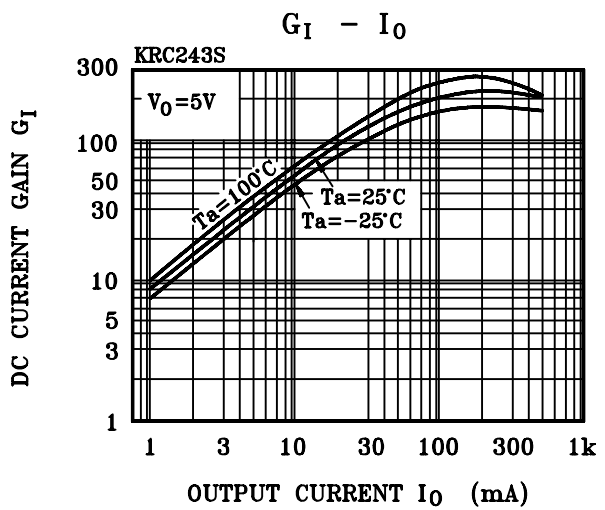
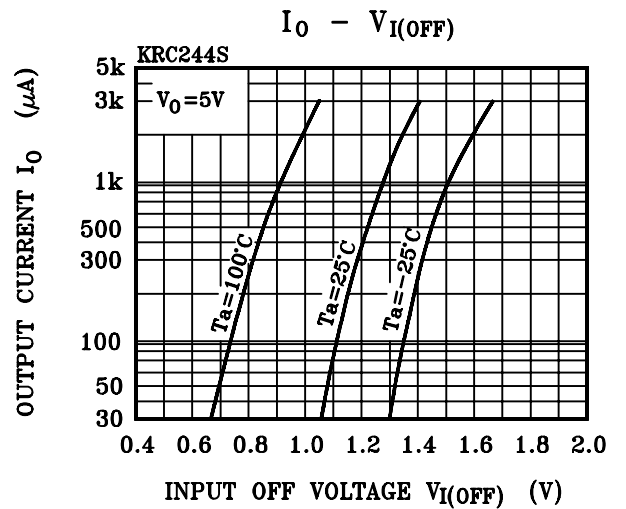
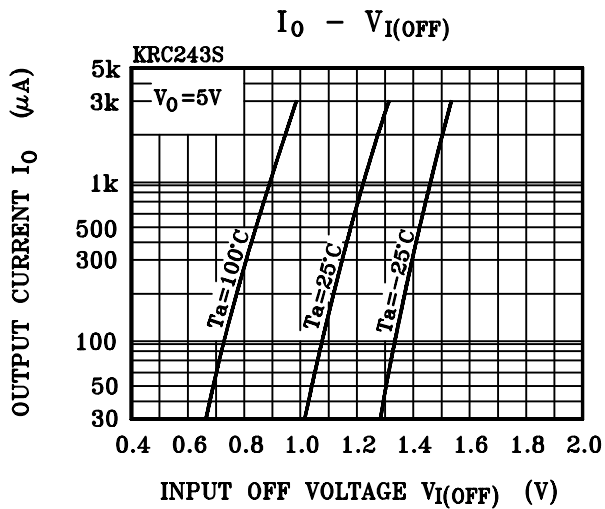
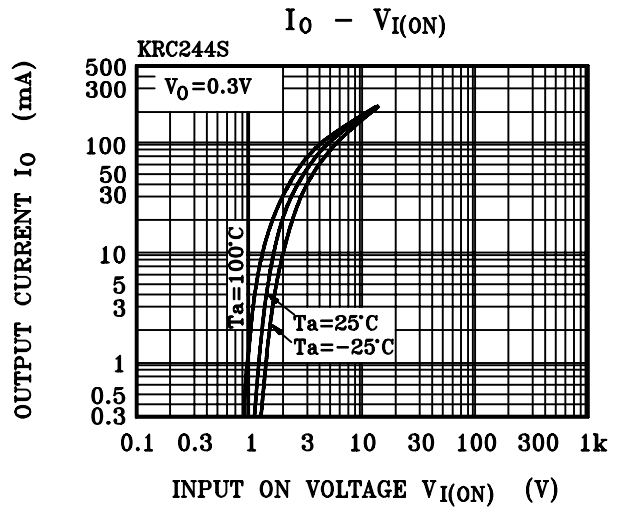
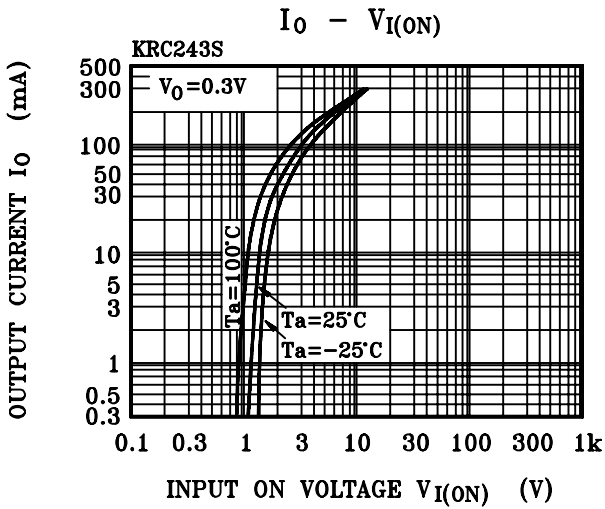

KRC241S ~ KRC246S

