

- $V_{DS}$  600 V
- $I_D$  0.080 A
- $R_{DS(on)}$  60  $\Omega$
- N channel
- Depletion mode
- High dynamic resistance
- Available grouped in  $V_{GS(th)}$

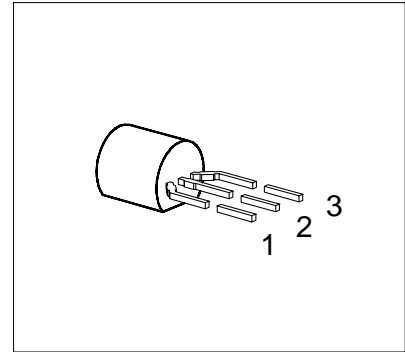

Type	Ordering Code	Tape and Reel Information	Pin Configuration			Marking	Package
			1	2	3		
BSS 135	Q67000-S237	E6325: 2000 pcs/carton; Ammopack	G	D	S	SS135	TO-92

### Maximum Ratings

Parameter	Symbol	Values	Unit
Drain-source voltage	$V_{DS}$	600	V
Drain-gate voltage, $R_{GS} = 20 \text{ k}\Omega$	$V_{DGR}$	600	
Gate-source voltage	$V_{GS}$	$\pm 14$	
Gate-source peak voltage, aperiodic	$V_{gs}$	$\pm 20$	
Continuous drain current, $T_A = 42 \text{ }^\circ\text{C}$	$I_D$	0.080	A
Pulsed drain current, $T_A = 25 \text{ }^\circ\text{C}$	$I_{D \text{ puls}}$	0.24	
Max. power dissipation, $T_A = 25 \text{ }^\circ\text{C}$	$P_{tot}$	1.0	W
Operating and storage temperature range	$T_j, T_{stg}$	$-55 \dots +150$	$^\circ\text{C}$
Thermal resistance, chip-ambient (without heat sink)	$R_{thJA}$	$\leq 125$	K/W
DIN humidity category, DIN 40 040	–	E	–
IEC climatic category, DIN IEC 68-1	–	55/150/56	–

## Electrical Characteristics

at  $T_j = 25\text{ °C}$ , unless otherwise specified.

Parameter	Symbol	Values			Unit
		min.	typ.	max.	

### Static Characteristics

Drain-source breakdown voltage $V_{GS} = -3\text{ V}$ , $I_D = 0.25\text{ mA}$	$V_{(BR)DSS}$	600	–	–	V
Gate threshold voltage $V_{DS} = 3\text{ V}$ , $I_D = 1\text{ mA}$	$V_{GS(th)}$	– 1.8	– 1.5	– 0.7	
Drain-source cutoff current $V_{DS} = 600\text{ V}$ , $V_{GS} = -3\text{ V}$ $T_j = 25\text{ °C}$ $T_j = 125\text{ °C}$	$I_{DSS}$	–	–	100 200	nA μA
Gate-source leakage current $V_{GS} = 20\text{ V}$ , $V_{DS} = 0$	$I_{GSS}$	–	10	100	nA
Drain-source on-resistance $V_{GS} = 0\text{ V}$ , $I_D = 0.01\text{ A}$	$R_{DS(on)}$	–	40	60	Ω

### Dynamic Characteristics

Forward transconductance $V_{DS} \geq 2 \times I_D \times R_{DS(on)max}$ , $I_D = 0.01\text{ A}$	$g_{fs}$	0.01	0.04	–	S
Input capacitance $V_{GS} = -3\text{ V}$ , $V_{DS} = 25\text{ V}$ , $f = 1\text{ MHz}$	$C_{iss}$	–	110	150	pF
Output capacitance $V_{GS} = -3\text{ V}$ , $V_{DS} = 25\text{ V}$ , $f = 1\text{ MHz}$	$C_{oss}$	–	8	12	
Reverse transfer capacitance $V_{GS} = -3\text{ V}$ , $V_{DS} = 25\text{ V}$ , $f = 1\text{ MHz}$	$C_{rss}$	–	3	5	
Turn-on time $t_{on}$ , ( $t_{on} = t_{d(on)} + t_r$ ) $V_{DD} = 30\text{ V}$ , $V_{GS} = -3\text{ V} \dots + 5\text{ V}$ , $R_{GS} = 50\text{ Ω}$ , $I_D = 0.2\text{ A}$	$t_{d(on)}$	–	4	6	ns
	$t_r$	–	10	15	
Turn-off time $t_{off}$ , ( $t_{off} = t_{d(off)} + t_f$ ) $V_{DD} = 30\text{ V}$ , $V_{GS} = -3\text{ V} \dots + 5\text{ V}$ , $R_{GS} = 50\text{ Ω}$ , $I_D = 0.2\text{ A}$	$t_{d(off)}$	–	15	20	
	$t_f$	–	20	30	

## Electrical Characteristics (cont'd)

at  $T_j = 25\text{ °C}$ , unless otherwise specified.

Parameter	Symbol	Values			Unit
		min.	typ.	max.	

### Reverse Diode

Continuous reverse drain current $T_A = 25\text{ °C}$	$I_S$	–	–	0.080	A
Pulsed reverse drain current $T_A = 25\text{ °C}$	$I_{SM}$	–	–	0.240	
Diode forward on-voltage $I_F = 0.16\text{ A}$ , $V_{GS} = 0$	$V_{SD}$	–	0.80	1.30	V

$V_{GS(th)}$ Grouping	Symbol	Limit Values		Unit	Test Condition
		min.	max.		
Range of $V_{GS(th)}$	$\Delta V_{GS(th)}$	–	0.15	V	–
Threshold voltage selected in groups <sup>1)</sup> :	$V_{GS(th)}$				$V_{DS1} = 0.2\text{ V};$ $V_{DS2} = 3\text{ V};$ $I_D = 1\text{ mA}$
P		– 0.95	– 0.80	V	
R		– 1.08	– 0.93	V	
S		– 1.21	– 1.06	V	
T		– 1.34	– 1.19	V	
U		– 1.47	– 1.32	V	
V		– 1.60	– 1.45	V	
W		– 1.73	– 1.58	V	

- 1) A specific group cannot be ordered separately.  
Each reel only contains transistors from one group.

**Characteristics**

at  $T_j = 25\text{ }^\circ\text{C}$ , unless otherwise specified.

**Total power dissipation  $P_{\text{tot}} = f(T_A)$**

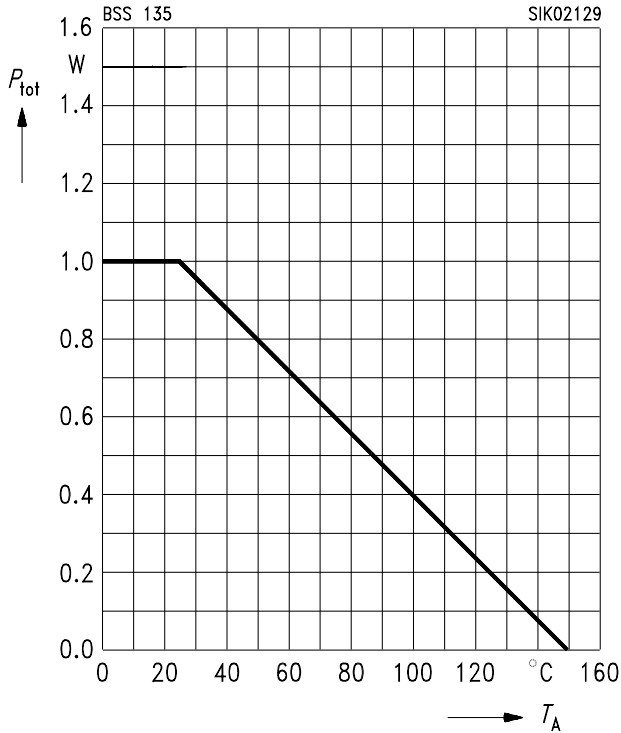

**Safe operating area  $I_D = f(V_{DS})$**

parameter:  $D = 0.01, T_C = 25\text{ }^\circ\text{C}$

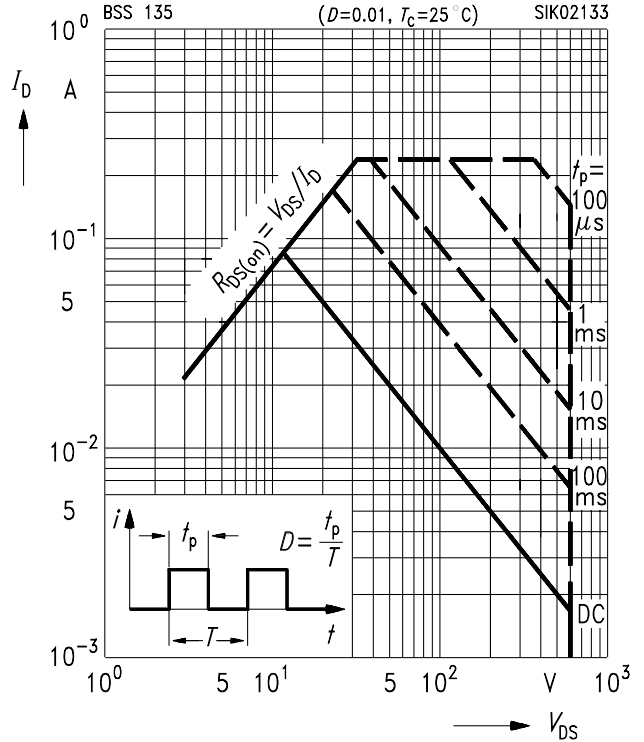

**Typ. output characteristics  $I_D = f(V_{DS})$**

parameter:  $t_p = 80\text{ }\mu\text{s}$

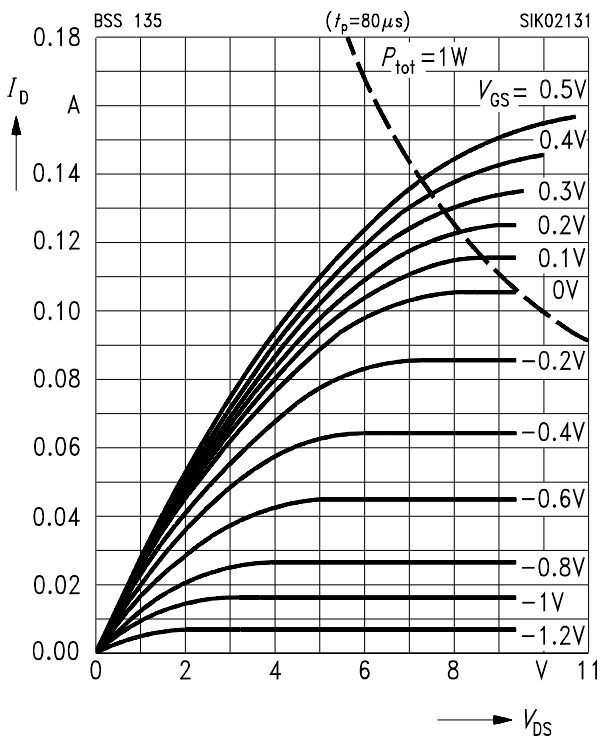

**Typ. drain-source on-resistance  $R_{DS(on)} = f(I_D)$**

parameter:  $V_{GS}$

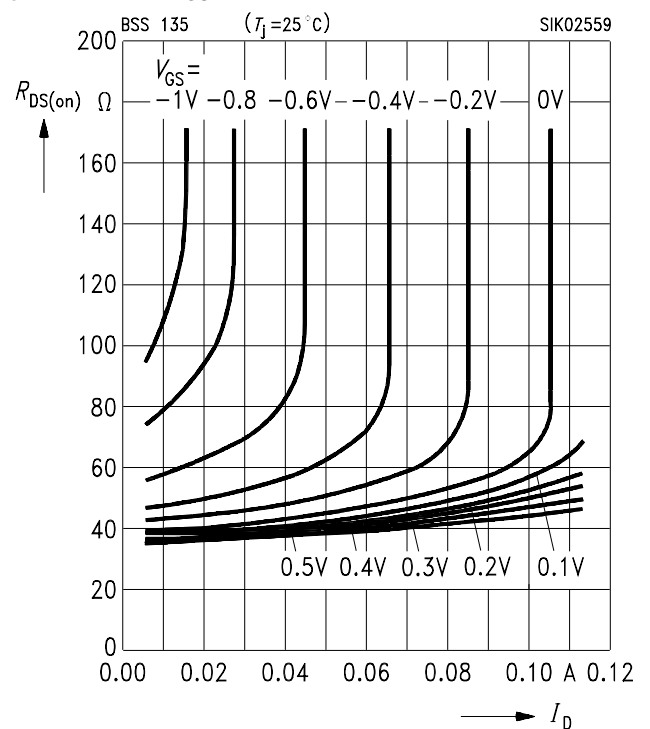

**Typ. transfer characteristics**  $I_D = f(V_{GS})$   
 parameter:  $t_p = 80 \mu s$ ,  $V_{DS} \geq 2 \times I_D \times R_{DS(on)max}$ .

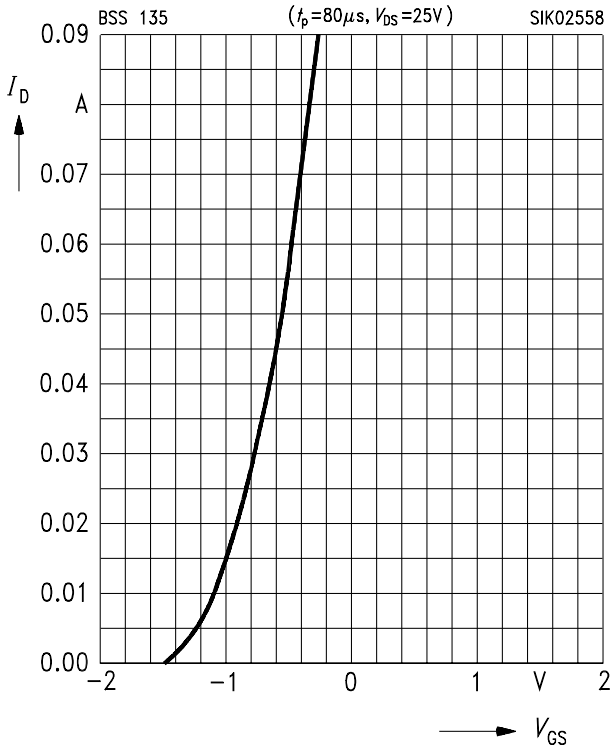

**Typ. forward transconductance**  $g_{fs} = f(I_D)$   
 parameter:  $V_{DS} \geq 2 \times I_D \times R_{DS(on)max}$ ,  $t_p = 80 \mu s$

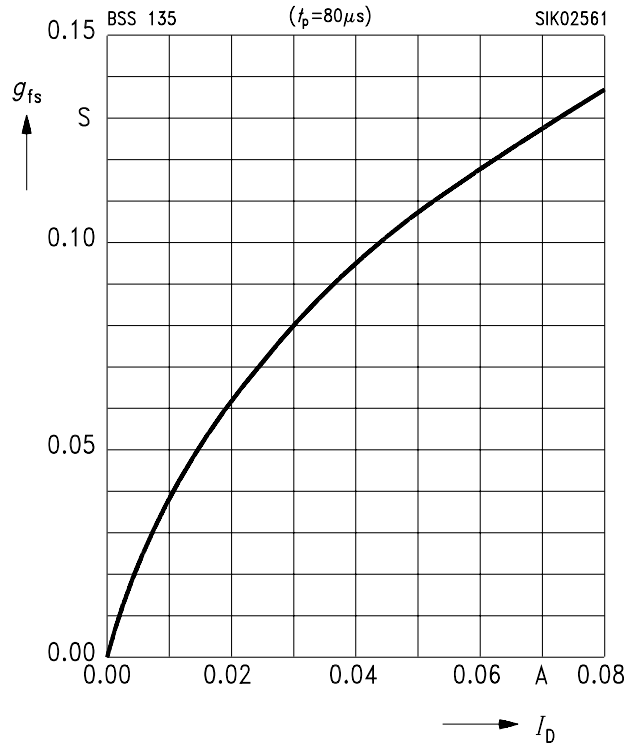

**Drain-source on-resistance**  
 $R_{DS(on)} = f(T_j)$   
 parameter:  $I_D = 0.01 A$ ,  $V_{GS} = 0 V$ , (spread)

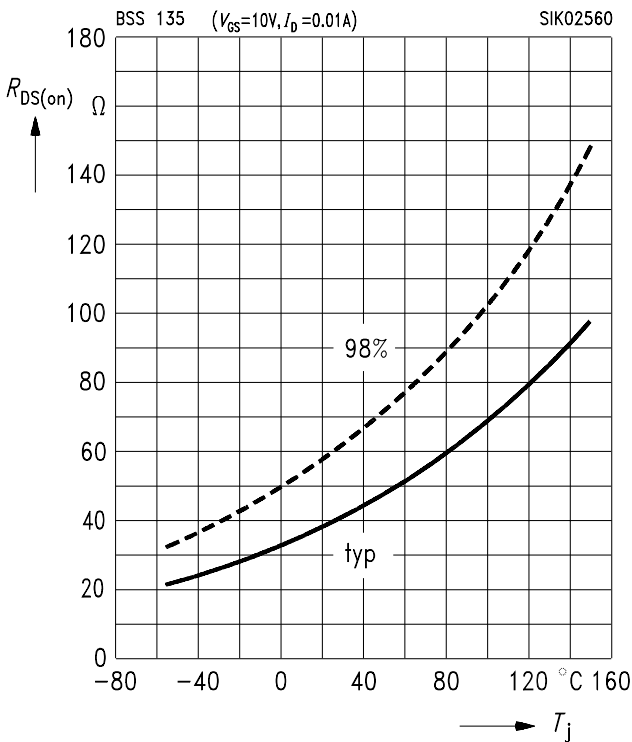

**Typ. capacitances**  $C = f(V_{DS})$   
 parameter:  $V_{GS} = 0 V$ ,  $f = 1 MHz$

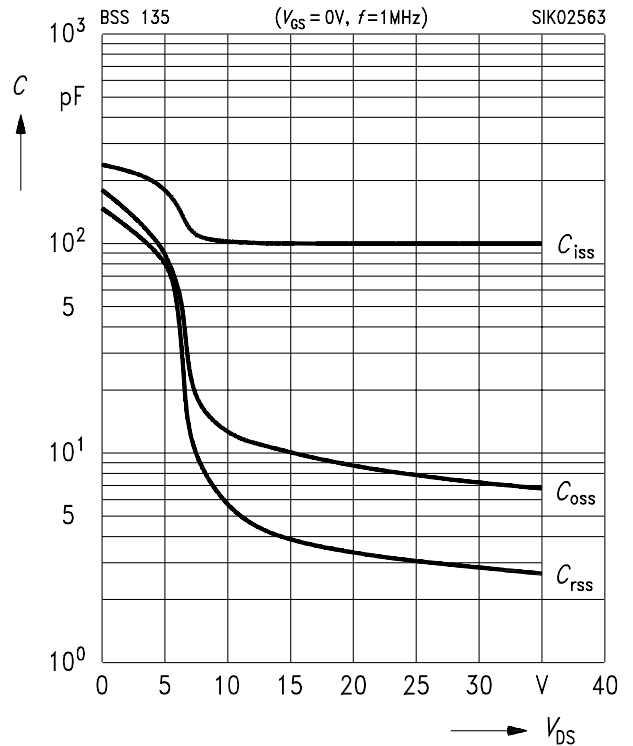

**Gate threshold voltage  $V_{GS(th)} = f(T_j)$**

parameter:  $V_{DS} = 3\text{ V}$ ,  $I_D = 1\text{ mA}$ , (spread)

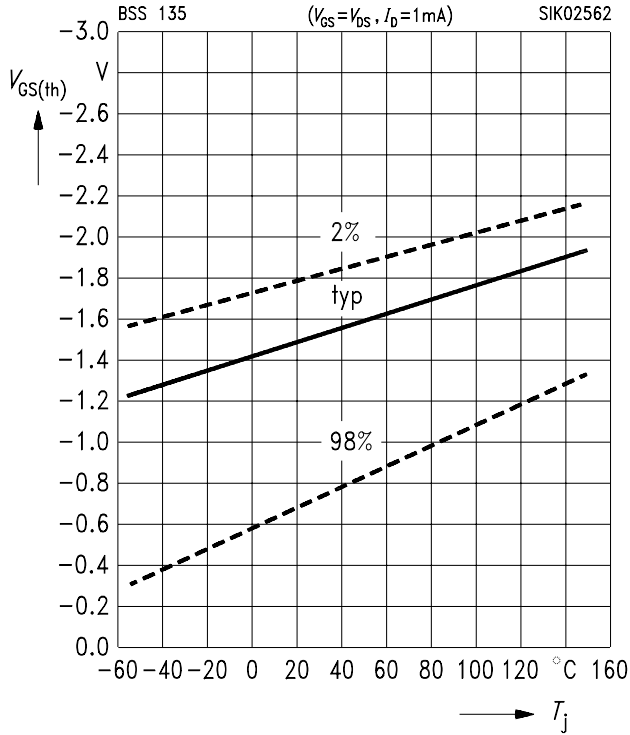

**Forward characteristics of reverse diode  $I_F = f(V_{SD})$**

parameter:  $t_p = 80\ \mu\text{s}$ ,  $T_j$ , (spread)

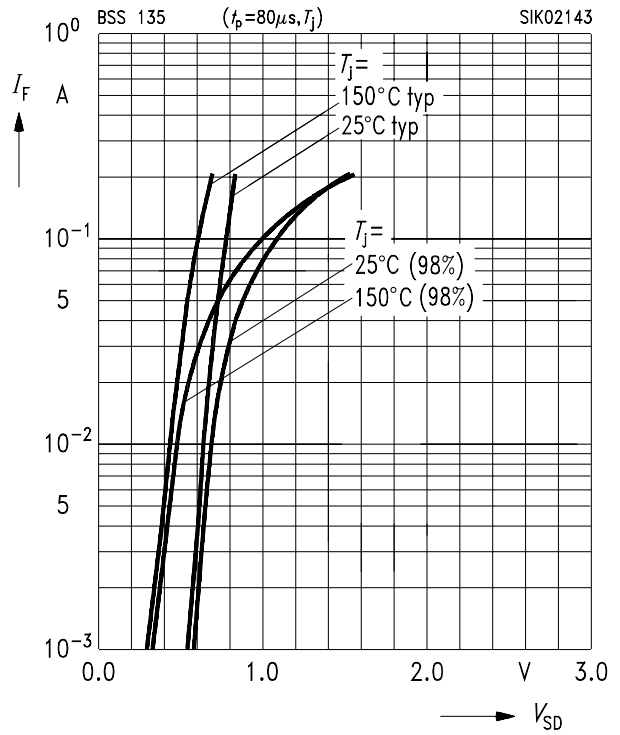

**Drain current  $I_D = f(T_A)$**

parameter:  $V_{GS} \geq 3\text{ V}$

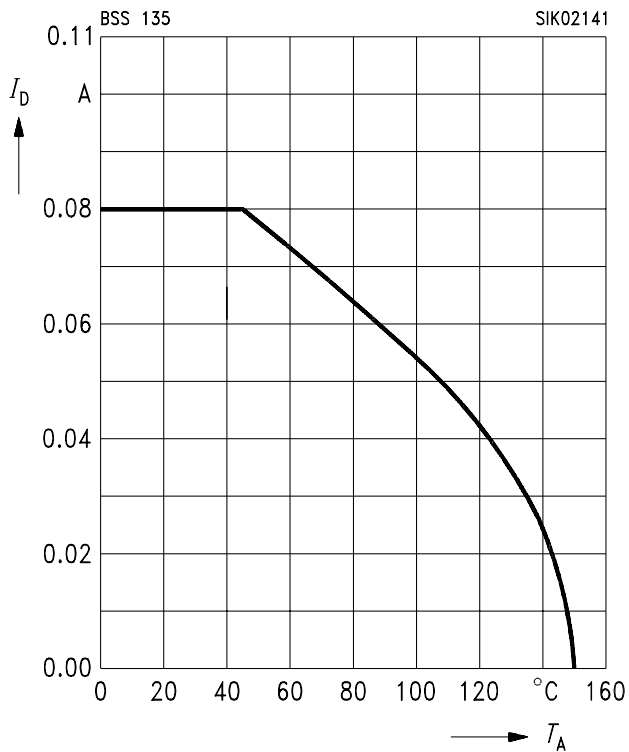

**Drain-source breakdown voltage**

$V_{(BR)DSS} = b \times V_{(BR)DSS}(25\text{ °C})$

