

## LSH 6355P

### 5 AMP DC-TO-DC MICROCONVERTER

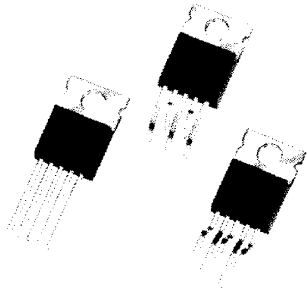

#### FEATURES

- Complete DC-to-DC converter
- 70% minimum efficiency
- 70kHz switching frequency
- Programmable output voltage from 5 to 27 Volts
- Preset output voltage of 5.05 Volts  $\pm 1.5\%$
- Current limit and thermal shutdown

#### DESCRIPTION

The LSH 6355P switching regulator is a micro-hybrid circuit designed for use in step-down applications requiring accurate output voltages over combined variations of line, load and temperature. This unique product greatly simplifies switching power supply design. The LSH 6355P micro-converter includes a switching regulator, catch diode and compensation network within a TO-220 style package. Just add a choke and two capacitors to obtain an efficient DC-to-DC converter for 5 Volts at 5 Amps. To increase the output voltage, simply add a programming resistor. The current limit and thermal shutdown features of the LSH 6355P fully protect the device against overstress conditions.

#### ABSOLUTE MAXIMUM RATINGS

PARAMETER	SYMBOL	MAXIMUM	UNITS
Input Voltage	$V_{IN}$	35	Volts
Power Dissipation	$P_D$	Internally Limited	Watts
Thermal Resistance Junction to Case	$\theta_{JC}$	4.5	$^{\circ}C/W$
Operating Junction and Storage Temperature Range	$T_J$ $T_{STG}$	- 25 to 125	$^{\circ}C$
Lead Temperature (Soldering, 10 Seconds)	$T_{LEAD}$	260	$^{\circ}C$

#### DEVICE SELECTION GUIDE

DEVICE	LEAD CONFIGURATION
LSH 6355P	straight in-line
LSH 6355PV	vertical staggered
LSH 6355PH	horizontal staggered

#### BLOCK DIAGRAM

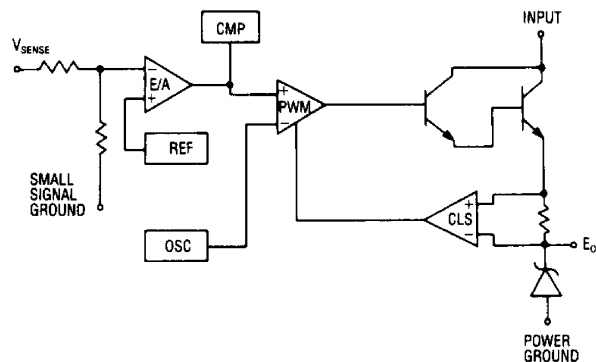

The LSH 6355P TO-220 style plastic package is available in three options to accommodate various mounting requirements. Available lead formations are straight in-line, staggered for vertical mount and staggered for horizontal mount.

## ELECTRICAL CHARACTERISTICS

Input test conditions are as follows:  $V_{IN} = 24\text{VDC}$ ,  $V_O = 5\text{VDC}$ ,  
 $I_O = 5\text{A}$ ,  $T_J = 25^\circ\text{C}$ , unless otherwise specified.

Parameter	Symbol	Test Conditions			Test Limits			Units
		$V_{IN}$	$I_O$	$T_J$	Minimum	Typical	Maximum	
Output Voltage <sup>1</sup>	$V_O$	12V to 35V	0A 0.5A to 5A	-25 to 125°C	4.97 4.80	5.05	5.13 5.30	Volts
Line Regulation <sup>1</sup>	$REG_{(LINE)}$	12V to 35V				90		mV
Load Regulation <sup>1</sup>	$REG_{(LOAD)}$		0.5A to 5A			45		mV
System Efficiency	$\eta$			-25 to 125°C	70	75		%
Switching Frequency	$f_{SX}$		50mA		58	70	86	kHz
Quiescent Current	$I_Q$	35V	0A			18	30	mA
Peak Current Limit Threshold	$I_{CL}$			-25 to 125°C	5.5		9	Amps
Output Noise and Ripple	$V_N$	$30V + 5V_{pk-pk}$ <sup>4</sup>				50		$mV_{pk-pk}$
Turn On Overshoot			0.5A to 5A			0		mV
Unit Step Load Change			0A to 5A 5A to 0.05A			0 250 <sup>2</sup>		mV $mV_{pk}$
Programming Resistance <sup>3</sup>		12V to 35V		-25 to 125°C		0.2		Volts/k $\Omega$

<sup>(1)</sup>Low duty cycle, pulse testing with Kelvin connections required.

<sup>(2)</sup>10mS duration.

<sup>(3)</sup> $V_O$  programming above 5.05V to 27V.

<sup>(4)</sup>120 Hz input ripple.

## TYPICAL APPLICATION

### DC-TO-DC STEP-DOWN CONVERTER<sup>1,2</sup>

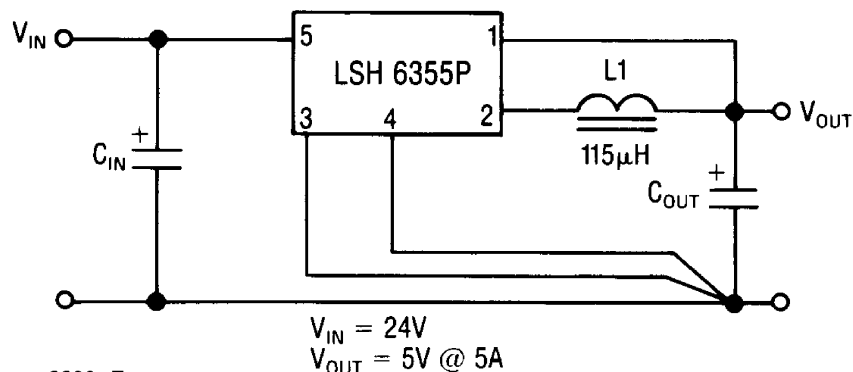

<sup>1</sup>  $C_{IN} = 470\mu\text{F}$ ;  $C_{OUT} = 2200\mu\text{F}$

<sup>2</sup> For output voltages above 5V, add programming resistor between Pin 1 and  $V_{OUT}$ .

## OPERATIONAL DATA

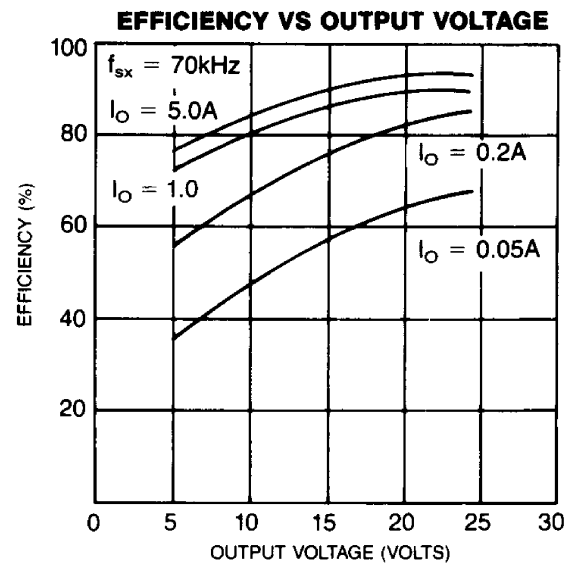
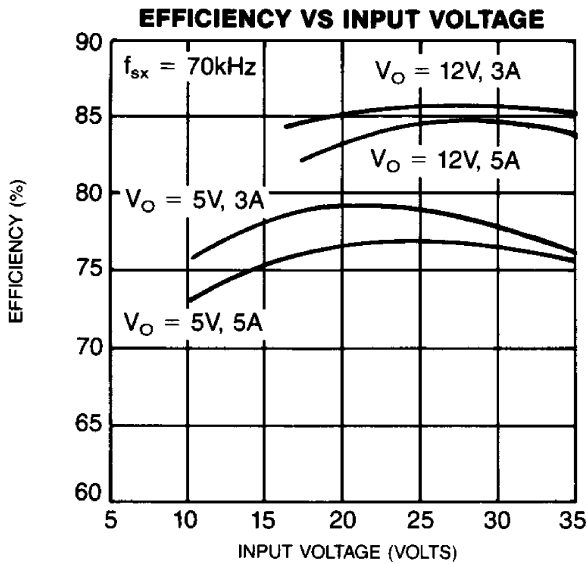
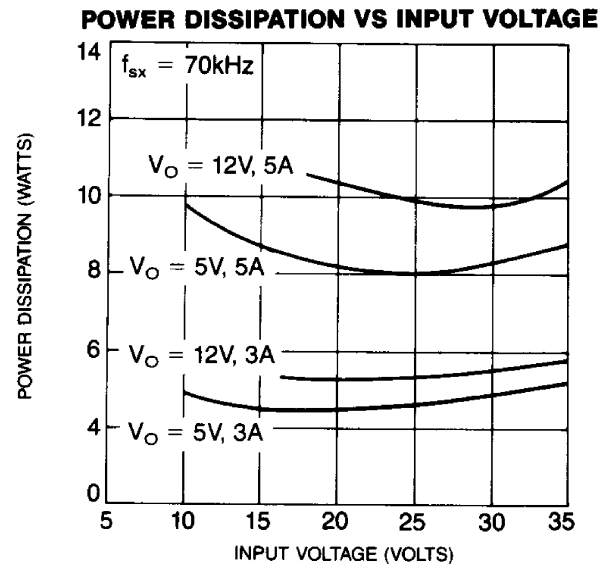
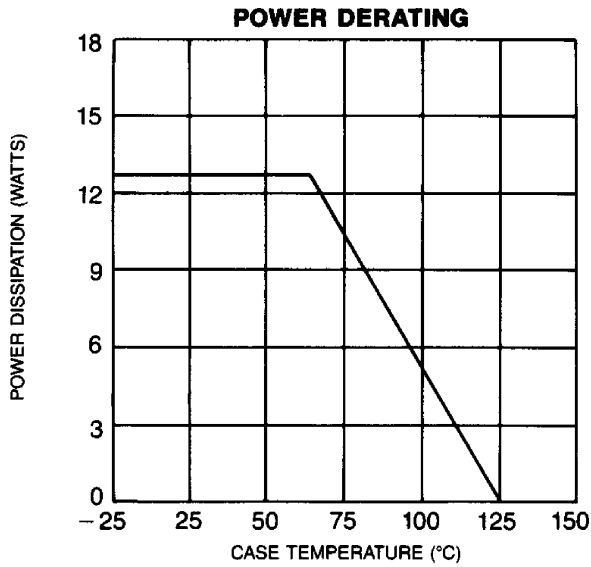

# LSH 6355P

## DEVICE OUTLINE

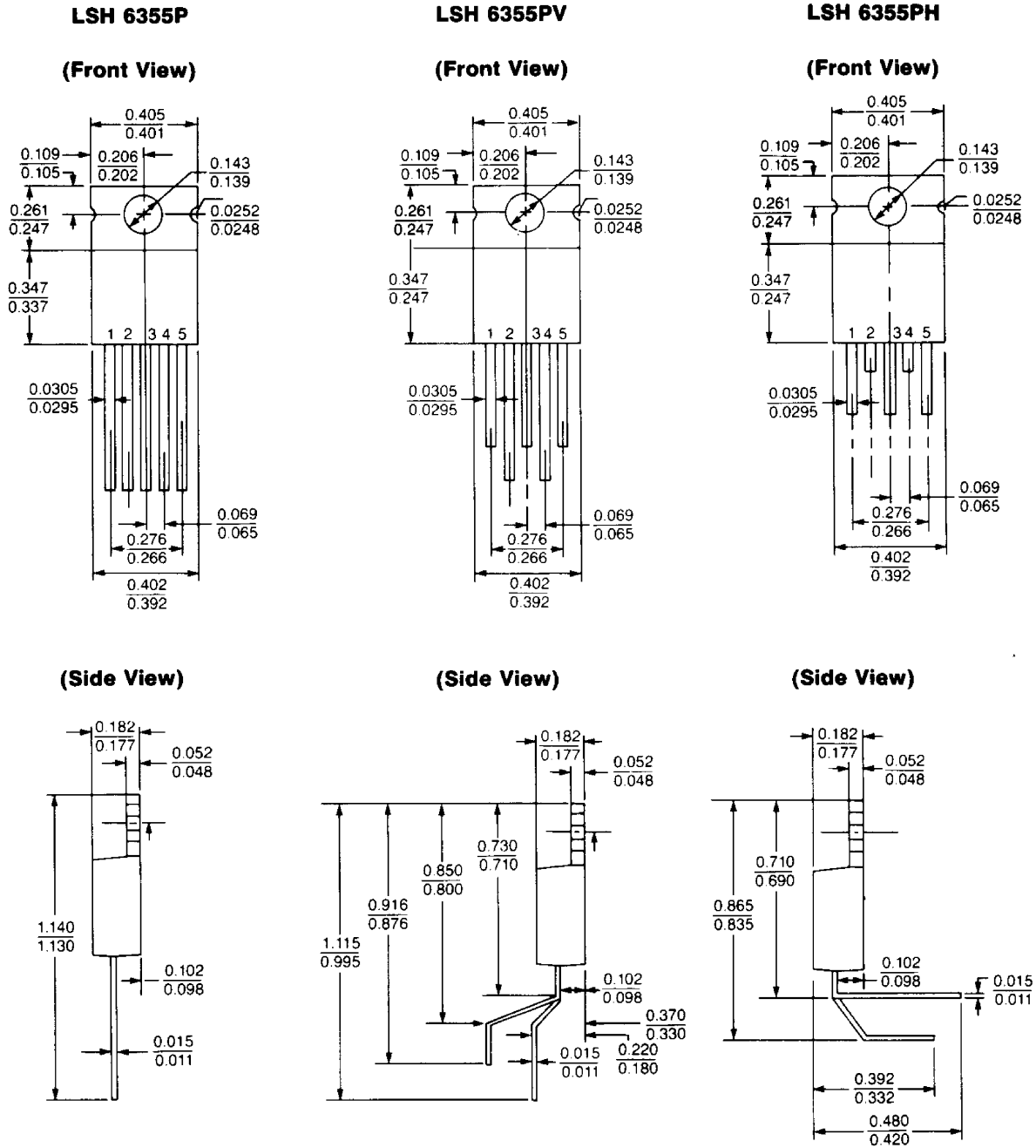

- |   |   |                            |
|---|---|----------------------------|
| 1 | — | $V_{SENSE}$                |
| 2 | — | $E_O$                      |
| 3 | — | Small Signal Ground        |
| 4 | — | Power Ground               |
| 5 | — | Input                      |
|   |   | Tab is Small Signal Ground |