

9097250 TOSHIBA (DISCRETE/OPTO)

56C 07966 D 7-33-13

SILICON NPN TRIPLE DIFFUSED MESA TYPE

**2SD1428**

COLOR TV HORIZONTAL OUTPUT APPLICATIONS.

## FEATURES:

- High Voltage :  $V_{CBO}=1500V$
- Low Saturation Voltage :  $V_{CE(sat)}=5V(\text{Max.})$  ( $I_C=5A$ ,  $I_B=1A$ )
- High Speed :  $t_f=1.0\mu s(\text{Max.})$
- Built-in Damper Type
- Glass Passivated Collector-Base Junction

MAXIMUM RATINGS ( $T_c=25^\circ C$ )

CHARACTERISTIC	SYMBOL	RATING	UNIT
Collector-Base Voltage	$V_{CBO}$	1500	V
Collector-Emitter Voltage	$V_{CEO}$	600	V
Emitter-Base Voltage	$V_{EBO}$	5	V
Collector Current	$I_C$	6	A
Emitter Current	$I_E$	-6	A
Collector Power Dissipation ( $T_c=25^\circ C$ )	$P_C$	80	W
Junction Temperature	$T_j$	150	$^\circ C$
Storage Temperature Range	$T_{stg}$	-55 ~ 150	$^\circ C$

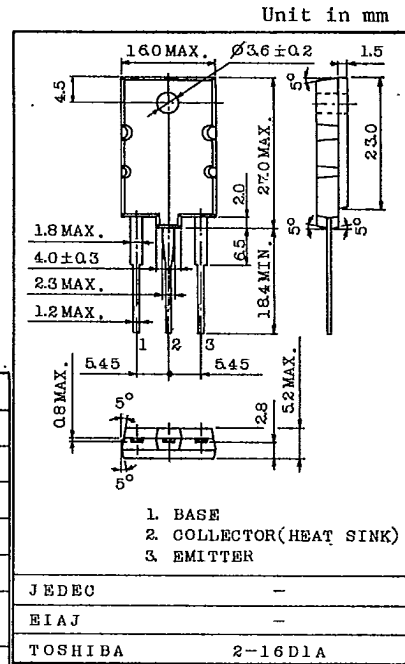

## EQUIVALENT CIRCUIT

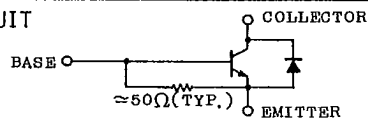
ELECTRICAL CHARACTERISTICS ( $T_c=25^\circ C$ )

CHARACTERISTIC	SYMBOL	TEST CONDITION	MIN.	TYP.	MAX.	UNIT
Collector Cut-off Current	$I_{CBO}$	$V_{CB}=500V$ , $I_E=0$	-	-	10	$\mu A$
Emitter-Base Breakdown Voltage	$V_{(BR)EBO}$	$I_E=200mA$ , $I_C=0$	5	-	-	V
DC Current Gain	$h_{FE}$	$V_{CE}=5V$ , $I_C=1A$	8	12	-	
Collector-Emitter Saturation Voltage	$V_{CE(sat)}$	$I_C=5A$ , $I_B=1A$	-	3	5	V
Base-Emitter Saturation Voltage	$V_{BE(sat)}$	$I_C=5A$ , $I_B=1A$	-	-	1.5	V
Forward Voltage (Damper Diode)	$-V_F$	$I_F=6A$	-	1.6	2.0	V
Transition Frequency	$f_T$	$V_{CE}=10V$ , $I_C=0.1A$	-	3	-	MHz
Collector Output Capacitance	$C_{ob}$	$V_{CB}=10V$ , $I_E=0$ , $f=1MHz$	-	165	-	pF
Fall Time (Fig.)	$t_f$	$I_{CP}=5A$ , $I_{Bl}(\text{end})=1A$	-	0.5	1.0	$\mu s$

TOSHIBA CORPORATION

# 2SD1428

Fig.  $t_f$  TEST CIRCUIT

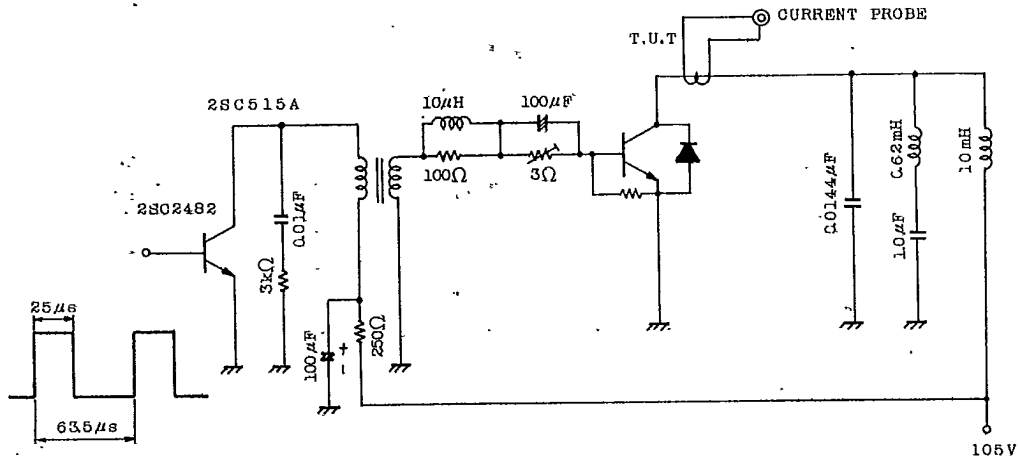

BASE CURRENT

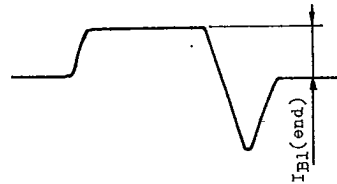

COLLECTOR CURRENT

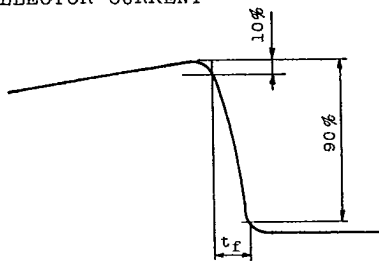

TOSHIBA CORPORATION

2SD1428

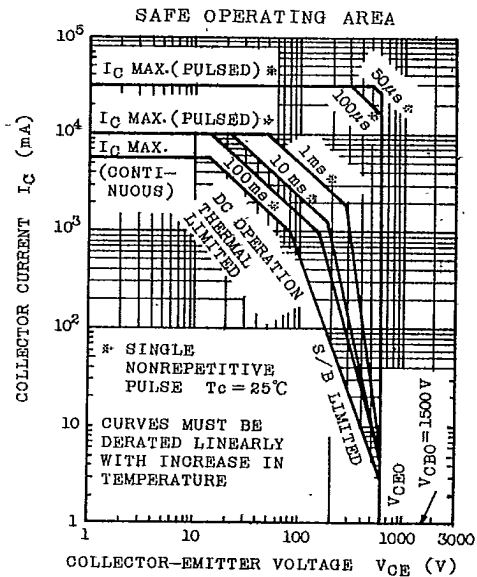
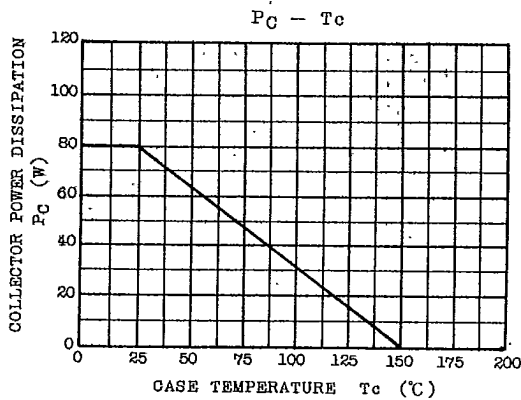
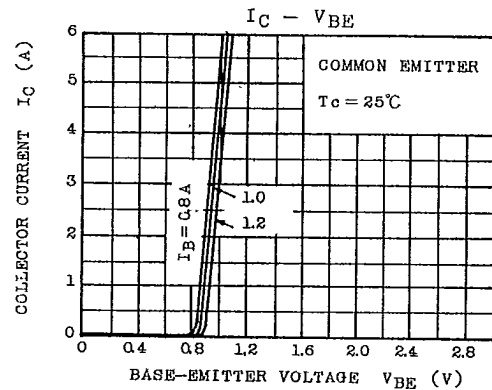
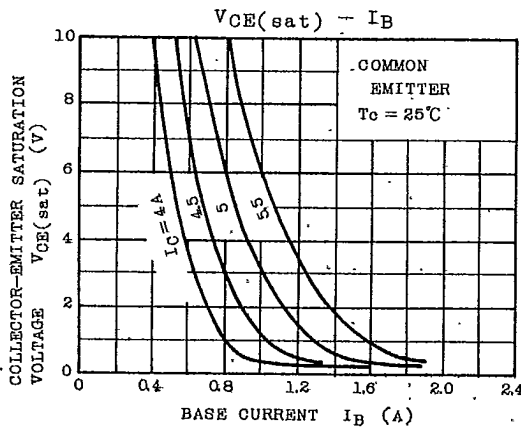
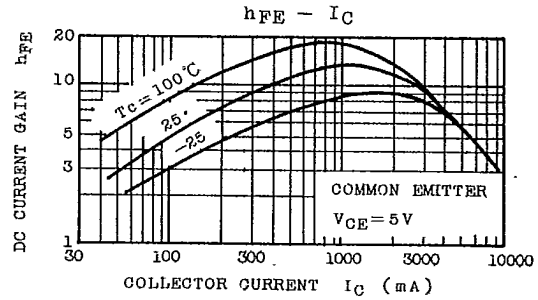
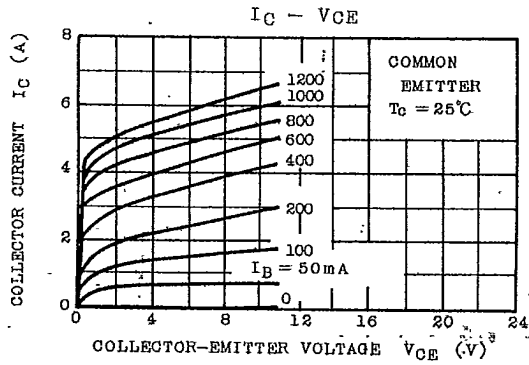

TOSHIBA CORPORATION