



# 70HF(R) SERIES

**POWER RECTIFIER**

**Reverse Voltage - 100 to 1600 Volts**

**Forward Current - 70.0 Amperes**

## Features

- High surge current capability
- Designed for a wide range of applications
- Stud cathode and stud anode version
- Leaded version available
- Types up to 1600V  $V_{RRM}$

## Typical Applications

- Battery charges
- Converters
- Power supplies
- Machine tool controls



case style  
DO-203AB (DO-5)

## Mechanical Data

- **Case:** DO-203AB(DO-5)
- **Polarity:** Selection available
- **Weight:** 17 grams

## Major Ratings and Characteristics

Parameters		70HF(R)		Units
		10 to 120	140 to 160	
$I_{F(AV)}$		70	70	Amps
	@ $T_C$	140	110	$^{\circ}C$
$I_{F(RMS)}$		110		Amps
$I_{FSM}$	@50Hz	1200		Amps
	@60Hz	1250		Amps
$I^2t$	@50Hz	7100		$A^2s$
	@60Hz	6540		$A^2s$
$V_{RRM}$	range	100 to 1200	1400 to 1600	Volts
$T_J$	range	-65 to 180	-65 to 150	$^{\circ}C$

# ELECTRICAL SPECIFICATIONS

## Voltage Ratings

Type number	Voltage Code	$V_{RRM}$ maximum repetitive peak reverse voltage Volts	$V_{RSM}$ maximum non-repetitive peak reverse voltage Volts	$V_{R(BR)}$ minimum avalanche voltage Volts <sup>(1)</sup>	$I_{RRM}$ max. @ $T_J=T_J$ max. mA
70HF(R)	10	100	200	-	15
	20	200	300	-	
	40	400	500	500	
	60	600	720	725	9
	80	800	960	950	
	100	1000	1200	1150	
	120	1200	1440	1350	4.5
	140	1400	1650	1550	
	160	1600	1900	1750	

(1) Avalanche version only available from  $V_{RRM}$  400V to 1600V.

## Forward Conduction

Parameter		70HF(R)		Units	Conditions		
		10 to 120	140 to 160				
$I_{F(AV)}$	Max. average forward current @ Case temperature	70	70	Amps	180° conduction, half sine wave		
		140	110	°C			
$I_{F(RMS)}$	Max. RMS forward current	110		Amps			
$I_{FSM}$	Max. peak, one-cycle forward, non-repetitive surge current	1200		Amps	t=10ms	No voltage reapplied	Sinusoidal half wave Initial $T_J=T_J$ max.
		1250			t=8.3ms		
		1000			t=10ms	100% $V_{RRM}$ reapplied	
		1050			t=8.3ms		
$I^2t$	Maximum $I^2t$ for fusing	7100		A <sup>2</sup> S	t=10ms	No voltage reapplied	
		6450			t=8.3s		
		5000			t=10ms	100% $V_{RRM}$ reapplied	
		4550			t=8.3ms		
$V_{FM}$	Max. forward voltage drop	1.35		Volts	$I_{pk}=220A, T_J=25°C, t_p=400\mu s$ rectangular wave		

## Thermal and Mechanical Specifications

Parameter	70HF(R)		Units	Conditions
	10 to 120	140 to 160		
T <sub>J</sub> Max. junction operating temperature range	-65 to 180	-65 to 150	°C	
T <sub>stg</sub> Max. storage temperature range	-65 to 180	-65 to 150		
R <sub>thJC</sub> Max. thermal resistance, junction to case	0.45		K/W	DC operation
R <sub>thCS</sub> Max. thermal resistance, case to heatsink	0.25			Mounting surface, smooth, flat and greased
T Max. allowed mounting torque 10%	2.3-2.4		Nm	Not lubricated threads
	20-30		lbf-in	
wt approximate weight	17 (0.6)		g(oz)	
Case style	DO-203AB (DO-5)			See Outline Table

### Ordering information Table

Device Code:     70    HF    R    160    M  
                               1        2        3        4        5

1. 70 - Standard device
2. HF - Standard diode
3. None - stud normal polarity (cathode to stud)  
       R - stud reverse polarity (Anode to stud)
4. Voltage code: cade x 10=V<sub>RRM</sub>
5. None - stud base DO-203AB (DO-5) 1/4" 28 UNF-2A  
       M - stud base DO-203AB (DO-5) M6x1

# Outlines Table

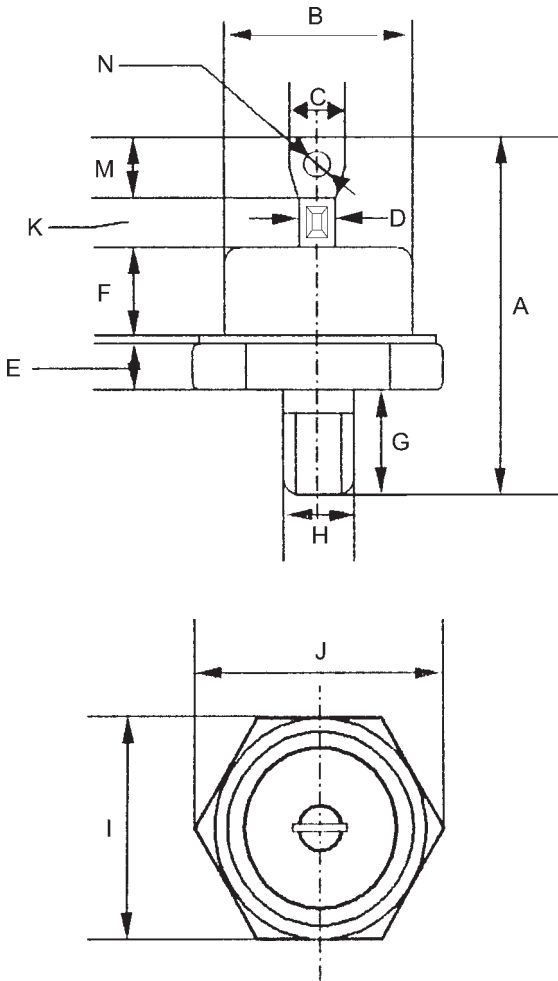

## 70HF(R)

Case Style DO-203AB(DO-5)

All dimenions in millimeters(inches)

DIMENSIONS			
DIM	inches	mm	Note
A		34.06	
B		12.83	
C		6.48	
D		3.68	
E		3.30	
F		5.92	
G		11.10	
H		5.84	
I		17.27	
J		19.05	
K		5.38	
M		7.42	
N		φ 3.8	

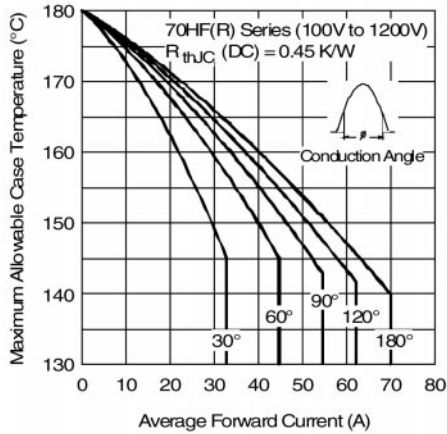

Fig. 1 - Current Ratings Characteristics

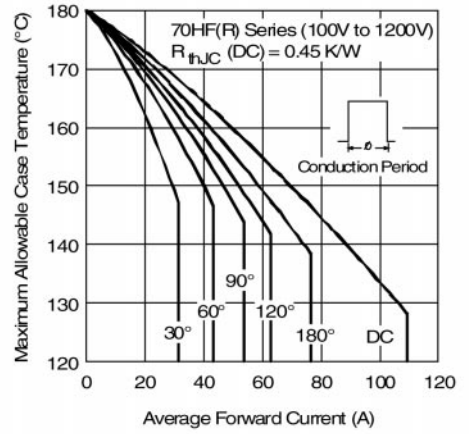

Fig. 2 - Current Ratings Characteristics

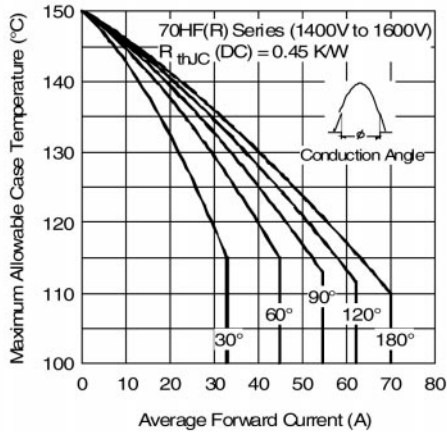

Fig. 3 - Current Ratings Characteristics

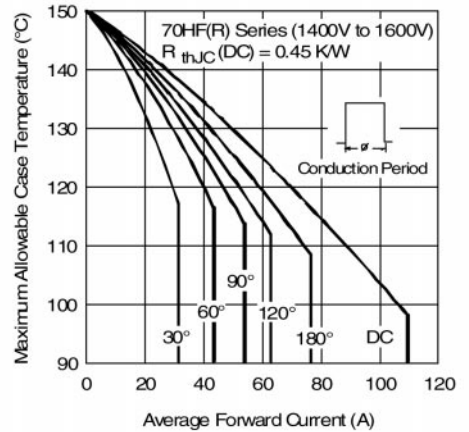

Fig. 4 - Current Ratings Characteristics

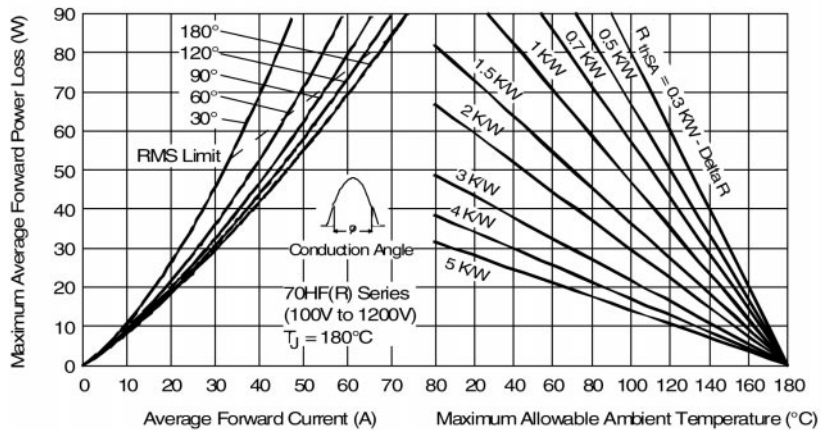

Fig. 5 - Forward Power Loss Characteristics

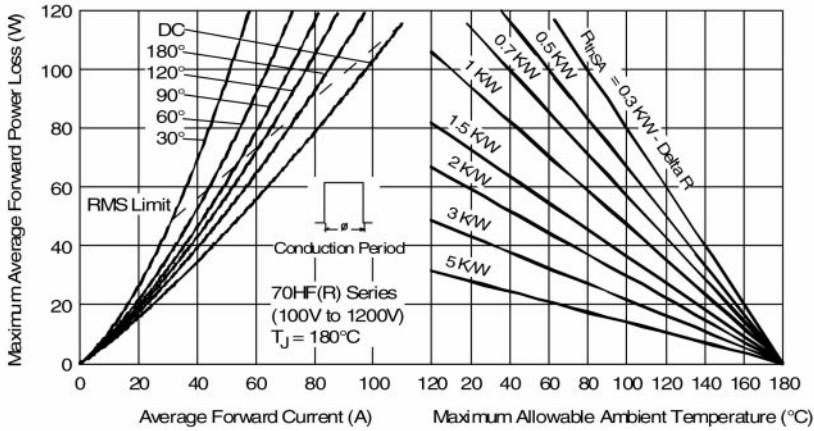

Fig. 6 - Forward Power Loss Characteristics

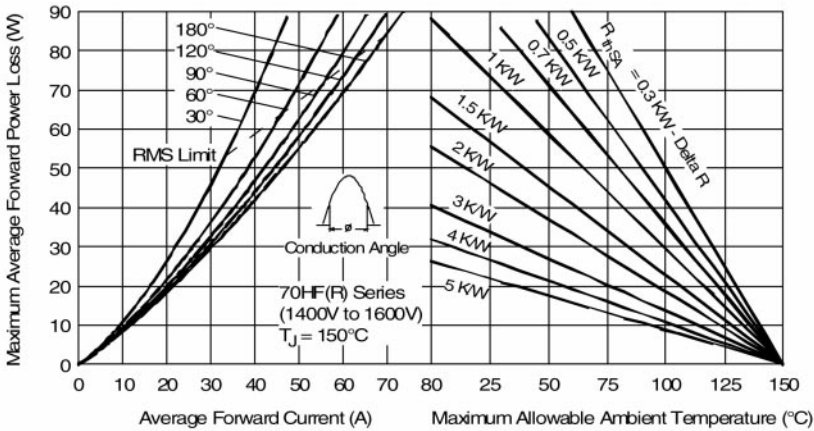

Fig. 7 - Forward Power Loss Characteristics

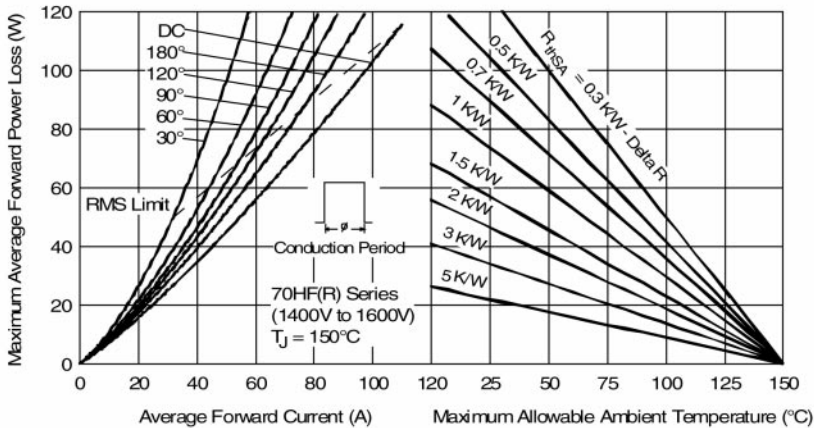

Fig. 8 - Forward Power Loss Characteristics

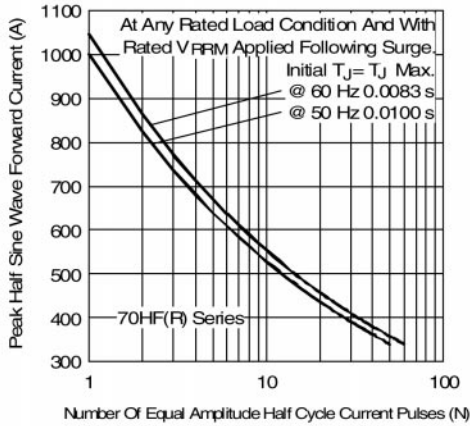

Fig. 9 - Maximum Non-Repetitive Surge Current

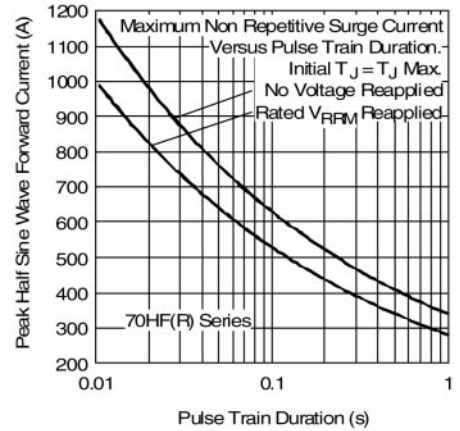

Fig. 10 - Maximum Non-Repetitive Surge Current

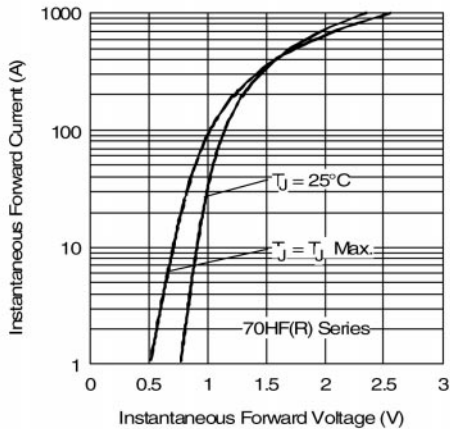

Fig. 11 - Forward Voltage Drop Characteristics

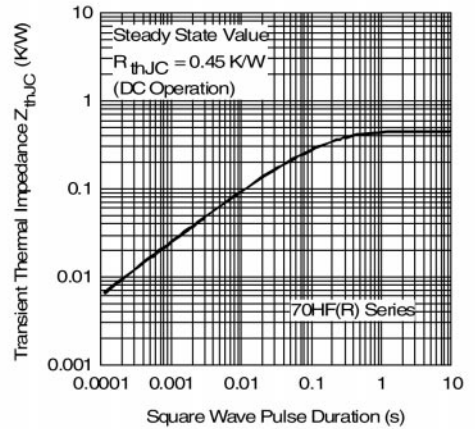

Fig. 12 - Thermal Impedance  $Z_{thJC}$  Characteristics