

FEATURES

Easy to Use
Low Cost Solution
Higher Performance than Two or Three Op Amp Design
Unity Gain with No External Resistor
Optional Gains with One External Resistor
 (Gain Range 2 to 1000)
Wide Power Supply Range (± 2.6 V to ± 15 V)
Available in 8-Lead PDIP and SOIC
Low Power, 1.5 mA max Supply Current

GOOD DC PERFORMANCE

0.15% Gain Accuracy ($G = 1$)
125 μ V max Input Offset Voltage
1.0 μ V/ $^{\circ}$ C max Input Offset Drift
5 nA max Input Bias Current
66 dB min Common-Mode Rejection Ratio ($G = 1$)

NOISE

12 nV/ $\sqrt{\text{Hz}}$ @ 1 kHz Input Voltage Noise
0.60 μ V p-p Noise (0.1 Hz to 10 Hz, $G = 10$)

EXCELLENT AC CHARACTERISTICS

800 kHz Bandwidth ($G = 10$)
10 μ s Settling Time to 0.1% @ $G = 1-100$
1.2 V/ μ s Slew Rate

APPLICATIONS

Transducer Interface
Low Cost Thermocouple Amplifier
Industrial Process Controls
Difference Amplifier
Low Cost Data Acquisition

CONNECTION DIAGRAM

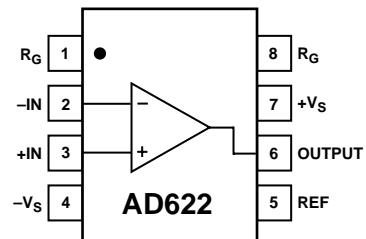

PRODUCT DESCRIPTION

The AD622 is a low cost, moderately accurate instrumentation amplifier that requires only one external resistor to set any gain between 2 and 1,000. Or for a gain of 1, no external resistor is required. The AD622 is a complete difference or subtracter amplifier "system" while providing superior linearity and common-mode rejection by incorporating precision laser trimmed resistors.

The AD622 replaces low cost, discrete, two or three op amp instrumentation amplifier designs and offers good common-mode rejection, superior linearity, temperature stability, reliability, and board area consumption. The low cost of the AD622 eliminates the need to design discrete instrumentation amplifiers to meet stringent cost targets. While providing a lower cost solution, it also provides performance and space improvements.

REV. C

Information furnished by Analog Devices is believed to be accurate and reliable. However, no responsibility is assumed by Analog Devices for its use, nor for any infringements of patents or other rights of third parties which may result from its use. No license is granted by implication or otherwise under any patent or patent rights of Analog Devices.

AD622—SPECIFICATIONS (typical @ +25°C, $V_S = \pm 15$ V, and $R_L = 2$ k Ω unless otherwise noted)

Model	Conditions	AD622			Units
		Min	Typ	Max	
GAIN	$G = 1 + (50.5 \text{ k}/R_G)$				
Gain Range		1		1000	
Gain Error ¹	$V_{OUT} = \pm 10$ V				
G = 1			0.05	0.15	%
G = 10			0.2	0.50	%
G = 100			0.2	0.50	%
G = 1000			0.2	0.50	%
Nonlinearity,	$V_{OUT} = \pm 10$ V				
G = 1–1000	$R_L = 10$ k Ω		10		ppm
G = 1–100	$R_L = 2$ k Ω		10		ppm
Gain vs. Temperature	Gain = 1			10	ppm/°C
	Gain >1 ¹			–50	ppm/°C
VOLTAGE OFFSET	(Total RTI Error = $V_{OSI} + V_{OSO}/G$)				
Input Offset, V_{OSI}	$V_S = \pm 5$ V to ± 15 V		60	125	μ V
Average TC	$V_S = \pm 5$ V to ± 15 V			1.0	μ V/°C
Output Offset, V_{OSO}	$V_S = \pm 5$ V to ± 15 V		600	1500	μ V
Average TC	$V_S = \pm 5$ V to ± 15 V			15	μ V/°C
Offset Referred to the Input vs. Supply (PSR)	$V_S = \pm 5$ V to ± 15 V				
G = 1		80	100		dB
G = 10		95	120		dB
G = 100		110	140		dB
G = 1000		110	140		dB
INPUT CURRENT					
Input Bias Current			2.0	5.0	nA
Average TC			3.0		pA/°C
Input Offset Current			0.7	2.5	nA
Average TC			2.0		pA/°C
INPUT					
Input Impedance					
Differential			10 2		G Ω pF
Common-Mode			10 2		G Ω pF
Input Voltage Range ²	$V_S = \pm 2.6$ V to ± 5 V	$-V_S + 1.9$		$+V_S - 1.2$	V
Over Temperature		$-V_S + 2.1$		$+V_S - 1.3$	V
	$V_S = \pm 5$ V to ± 18 V	$-V_S + 1.9$		$+V_S - 1.4$	V
Over Temperature		$-V_S + 2.1$		$+V_S - 1.4$	V
Common-Mode Rejection Ratio DC to 60 Hz with 1 k Ω Source Imbalance	$V_{CM} = 0$ V to ± 10 V				
G = 1		66	78		dB
G = 10		86	98		dB
G = 100		103	118		dB
G = 1000		103	118		dB
OUTPUT					
Output Swing	$R_L = 10$ k Ω , $V_S = \pm 2.6$ V to ± 5 V	$-V_S + 1.1$		$+V_S - 1.2$	V
Over Temperature		$-V_S + 1.4$		$+V_S - 1.3$	V
	$V_S = \pm 5$ V to ± 18 V	$-V_S + 1.2$		$+V_S - 1.4$	V
Over Temperature		$-V_S + 1.6$		$+V_S - 1.5$	V
Short Current Circuit			± 18		mA

Model	Conditions	AD622			Units	
		Min	Typ	Max		
DYNAMIC RESPONSE						
Small Signal –3 dB Bandwidth	10 V Step					
G = 1			1000		kHz	
G = 10			800		kHz	
G = 100			120		kHz	
G = 1000			12		kHz	
Slew Rate				1.2	V/μs	
Settling Time to 0.1%						
G = 1–100			10	μs		
NOISE						
Voltage Noise, 1 kHz	$Total\ RTI\ Noise = \sqrt{(e_{ni}^2) + (e_{no}/G)^2}$					
Input, Voltage Noise, e_{ni}			12		nV/√Hz	
Output, Voltage Noise, e_{no}			72		nV/√Hz	
RTI, 0.1 Hz to 10 Hz	f = 1 kHz					
G = 1			4.0		μV p-p	
G = 10			0.6		μV p-p	
G = 100–1000			0.3		μV p-p	
Current Noise				100	fA/√Hz	
0.1 Hz to 10 Hz			10	pA p-p		
REFERENCE INPUT						
R_{IN}	$V_{IN+}, V_{REF} = 0$		20		kΩ	
I_{IN}			+50	+60	μA	
Voltage Range			– $V_S + 1.6$		+ $V_S - 1.6$	V
Gain to Output				1 ± 0.0015		
POWER SUPPLY						
Operating Range ³	$V_S = \pm 2.6\text{ V to } \pm 18\text{ V}$	±2.6		±18	V	
Quiescent Current			0.9	1.3	mA	
Over Temperature			1.1	1.5	mA	
TEMPERATURE RANGE						
For Specified Performance			–40 to +85		°C	

NOTES

¹Does not include effects of external resistor R_G .²One input grounded. G = 1.³This is defined as the same supply range that is used to specify PSR.

Specifications subject to change without notice.

AD622

ABSOLUTE MAXIMUM RATINGS¹

Supply Voltage	±18 V
Internal Power Dissipation ²	650 mW
Input Voltage (Common Mode)	±V _S
Differential Input Voltage	±25 V
Output Short Circuit Duration	Indefinite
Storage Temperature Range (N, R)	-65°C to +125°C
Operating Temperature Range	
AD622A	-40°C to +85°C
Lead Temperature Range	
(Soldering 10 seconds)	+300°C

NOTES

¹Stresses above those listed under Absolute Maximum Ratings may cause permanent damage to the device. This is a stress rating only; functional operation of the device at these or any other conditions above those indicated in the operational section of this specification is not implied. Exposure to absolute maximum rating conditions for extended periods may affect device reliability.

²Specification is for device in free air:

8-Lead Plastic Package: $\theta_{JA} = 95^{\circ}\text{C}/\text{Watt}$

8-Lead SOIC Package: $\theta_{JA} = 155^{\circ}\text{C}/\text{Watt}$

CAUTION

ESD (electrostatic discharge) sensitive device. Electrostatic charges as high as 4000 V readily accumulate on the human body and test equipment and can discharge without detection. Although the AD622 features proprietary ESD protection circuitry, permanent damage may occur on devices subjected to high energy electrostatic discharges. Therefore, proper ESD precautions are recommended to avoid performance degradation or loss of functionality.



ORDERING GUIDE

Model	Temperature Range	Package Option*
AD622AN	-40°C to +85°C	N-8
AD622AR	-40°C to +85°C	SO-8
AD622AR-REEL	-40°C to +85°C	13" Reel
AD622AR-REEL7	-40°C to +85°C	7" Reel

*N = Plastic DIP, SO = Small Outline.

Typical Characteristics (@ +25°C, V_S = ±15 V, R_L = 2 kΩ, unless otherwise noted)

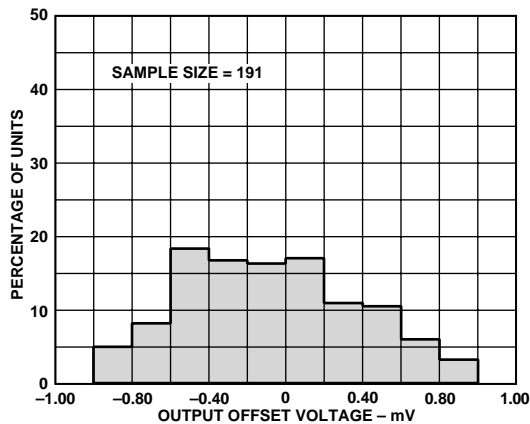

Figure 1. Typical Distribution of Output Offset Voltage

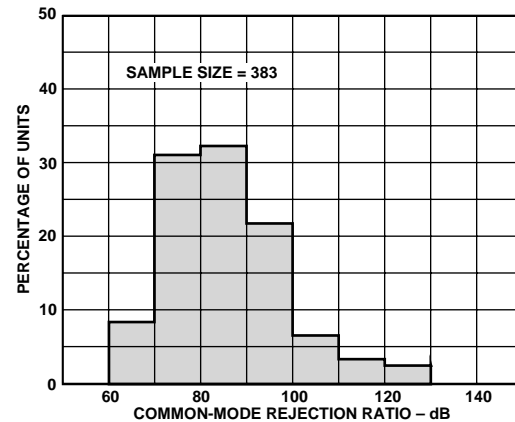

Figure 2. Typical Distribution of Common-Mode Rejection

Typical Characteristics (@ +25°C, $V_S = \pm 15\text{ V}$, $R_L = 2\text{ k}\Omega$, unless otherwise noted)

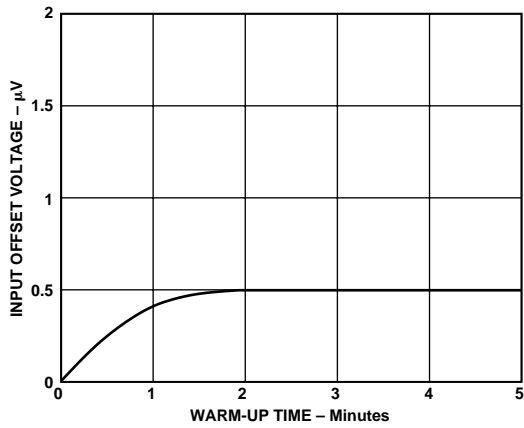

Figure 3. Change in Input Offset Voltage vs. Warm-Up Time

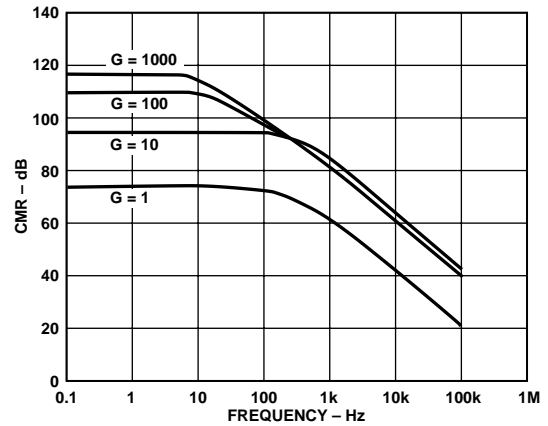

Figure 6. CMR vs. Frequency, RTI, Zero to 1 kΩ Source Imbalance

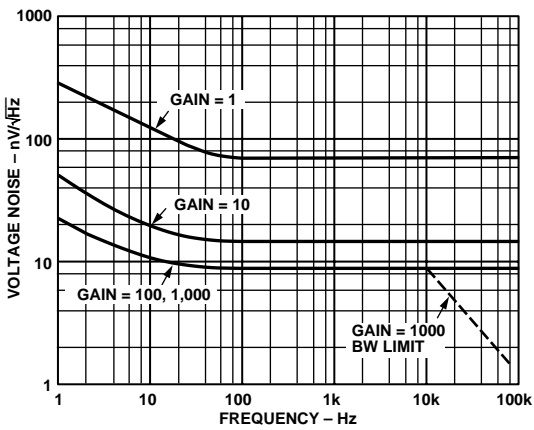

Figure 4. Voltage Noise Spectral Density vs. Frequency, (G = 1–1000)

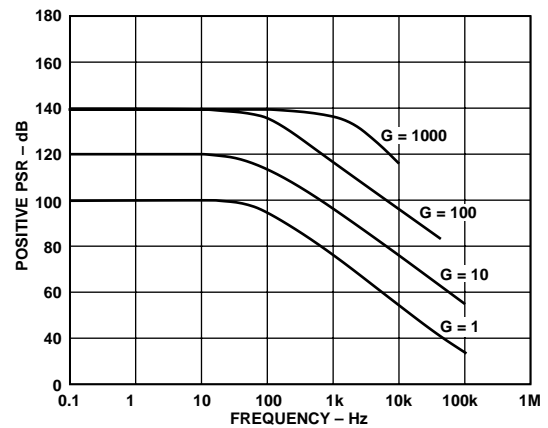

Figure 7a. Positive PSR vs. Frequency, RTI (G = 1–1000)

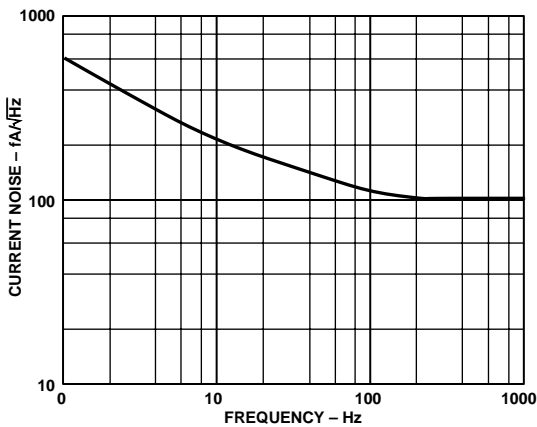

Figure 5. Current Noise Spectral Density vs. Frequency

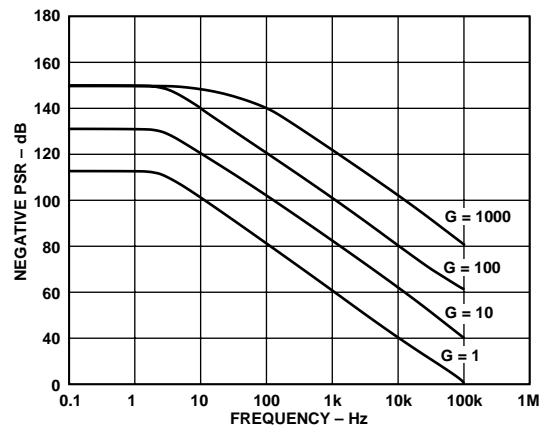

Figure 7b. Negative PSR vs. Frequency, RTI (G = 1–1000)

AD622—Typical Characteristics (@ +25°C, $V_S = \pm 15\text{ V}$, $R_L = 2\text{ k}\Omega$, unless otherwise noted)

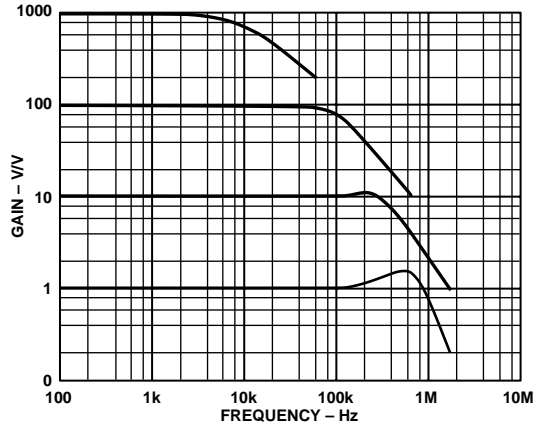

Figure 8. Gain vs. Frequency

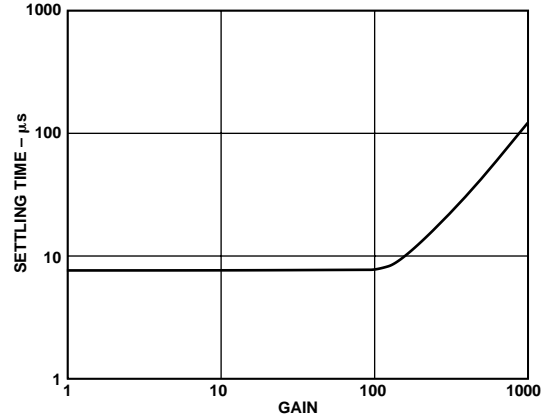

Figure 11. Settling Time to 0.1% vs. Gain, for a 10 V Step

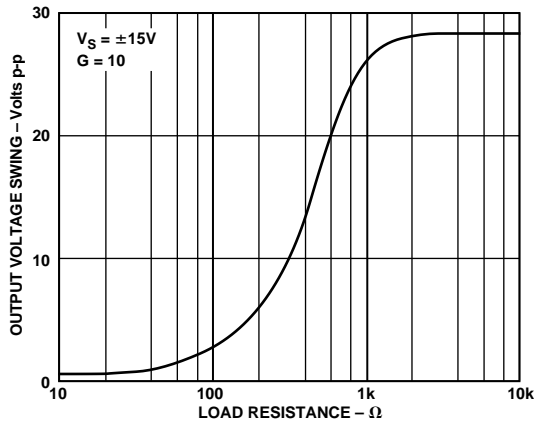

Figure 9. Output Voltage Swing vs. Load Resistance

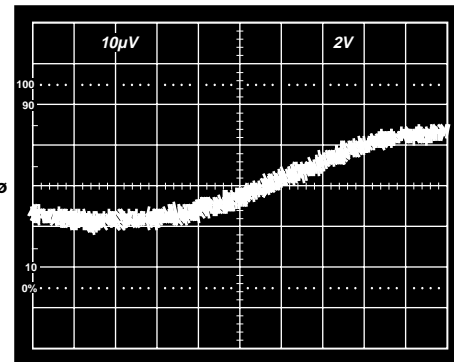

Figure 12. Gain Nonlinearity, $G = 1$, $R_L = 10\text{ k}\Omega$ ($20\text{ }\mu\text{V} = 2\text{ ppm}$)

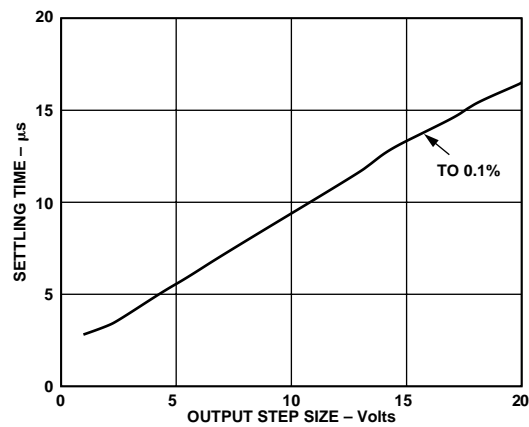

Figure 10. Settling Time vs. Step Size ($G = 1$)

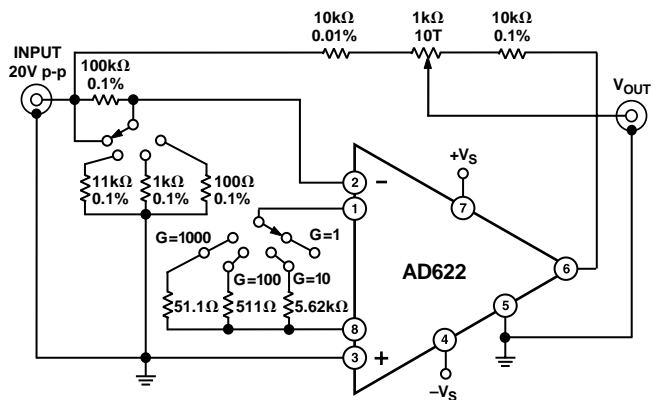

Figure 13. Settling Time Test Circuit

THEORY OF OPERATION

The AD622 is a monolithic instrumentation amplifier based on a modification of the classic three op-amp approach. Absolute value trimming allows the user to program gain *accurately* (to 0.5% at $G = 100$) with only one resistor. Monolithic construction and laser wafer trimming allow the tight matching and tracking of circuit components, thus insuring its performance.

The input transistors Q1 and Q2 provide a single differential-pair bipolar input for high precision. Feedback through the Q1-A1-R1 loop and the Q2-A2-R2 loop maintains constant collector current of the input devices Q1, Q2 thereby impressing the input voltage across the external gain-setting resistor R_G . This creates a differential gain from the inputs to the A1/A2 outputs given by $G = (R_1 + R_2)/R_G + 1$. The unity-gain subtracter A3 removes any common-mode signal, yielding a single-ended output referred to the REF pin potential.

The value of R_G also determines the transconductance of the preamp stage. As R_G is reduced for larger gains, the transconductance increases asymptotically to that of the input transistors. This has three important advantages: (a) Open-loop gain is boosted for increasing programmed gain, thus reducing gain-related errors. (b) The gain-bandwidth product (determined by C1, C2 and the preamp transconductance) increases with programmed gain, thus optimizing frequency response. (c) The input voltage noise is reduced to a value of $12 \text{ nV}/\sqrt{\text{Hz}}$, determined mainly by the collector current and base resistance of the input devices.

The internal gain resistors, R1 and R2, are trimmed to an absolute value of $25.25 \text{ k}\Omega$, allowing the gain to be programmed accurately with a single external resistor.

Make vs. Buy: A Typical Application Error Budget

The AD622 offers a cost and performance advantages over discrete “two op-amp” instrumentation amplifier designs along with smaller size and less components. In a typical application shown in Figure 14, a gain of 10 is required to receive and amplify a 0–20 mA signal from the AD694 current transmitter. The current is converted to a voltage in a 50Ω shunt. In applications where transmission is over long distances, line impedance can be significant so that differential voltage measurement is essential. Where there is no connection between the ground returns of transmitter and receiver, there must be a dc path from each input to ground, implemented in this case using two $1 \text{ k}\Omega$ resistors. The error budget detailed in Table I shows how to calculate the effect various error sources have on circuit accuracy.

The AD622 provides greater accuracy at lower cost. The higher cost of the “homebrew” circuit is dominated in this case by the matched resistor network. One could also realize a “homebrew” design using cheaper discrete resistors which would be either trimmed or hand selected to give high common-mode rejection. This level of common-mode rejection would however degrade significantly over temperature due to the drift mismatch of the discrete resistors.

Note that for the homebrew circuit, the LT1013 specification for noise has been multiplied by $\sqrt{2}$. This is because a “two op-amp” type instrumentation amplifier has two op amps at its inputs, both contributing to the overall noise.

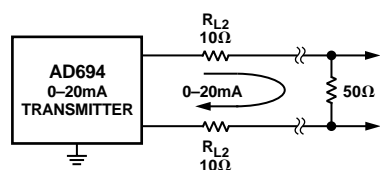

0–20 mA Current Loop
with 50Ω Shunt Impedance

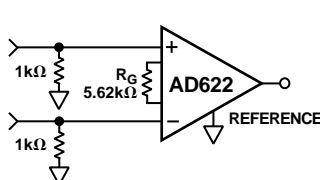

AD622 Monolithic
Instrumentation Amplifier,
 $G = 9.986$

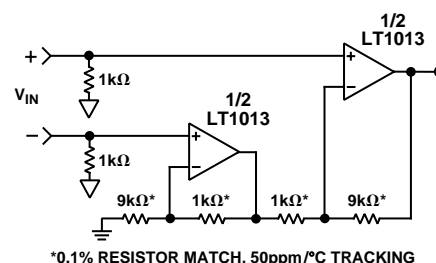

“Homebrew” In Amp, $G = 10$

Figure 14. Make vs. Buy

Table I. Make vs. Buy Error Budget

Error Source	AD622 Circuit Calculation	“Homebrew” Circuit Calculation	Total Error in ppm Relative to 1 V FS AD622	Total Error in ppm Relative to 1 V FS Homebrew
ABSOLUTE ACCURACY at T_A = +25°C				
Total RTI Offset Voltage, μV	250 μV + 1500 μV/10	800 μV × 2	400	1600
Input Offset Current, nA	2.5 nA × 1 kΩ	15 nA × 1 kΩ	2.5	15
CMR, dB	86 dB → 50 ppm × 0.5 V	(0.1% Match × 0.5 V)/10 V	25	50
Total Absolute Error			427.5	1665
DRIFT TO +85°C				
Gain Drift, ppm/°C	(50 ppm + 5 ppm) × 60°C	(50 ppm)/°C × 60°C	3300	3000
Total RTI Offset Voltage, μV/°C	(2 μV/°C + 15 μV/°C/10) × 60°C	9 μV/°C × 2 × 60°C	210	1080
Input Offset Current, pA/°C	2 pA/°C × 1 kΩ × 60°C	155 pA/°C × 1 kΩ × 60°C	0.12	9.3
Total Drift Error			3510.12	4089.3
RESOLUTION				
Gain Nonlinearity, ppm of Full Scale	10 ppm	20 ppm	10	20
Typ 0.1 Hz–10 Hz Voltage Noise, μV p-p	0.6 μV p-p	0.55 μV p-p × √2	0.6	0.778
Total Resolution Error			10.6	20.778
Grand Total Error			3948	5575

GAIN SELECTION

The AD622’s gain is resistor programmed by R_G, or more precisely, by whatever impedance appears between Pins 1 and 8. The AD622 is designed to offer gains as close as possible to popular integer values using standard 1% resistors. Table II shows required values of R_G for various gains. Note that for G = 1, the R_G pins are unconnected (R_G = ∞). For any arbitrary gain R_G can be calculated by using the formula

$$R_G = \frac{50.5 \text{ k}\Omega}{G - 1}$$

To minimize gain error avoid high parasitic resistance in series with R_G, and to minimize gain drift, R_G should have a low TC—less than 10 ppm/°C for the best performance.

Table II. Required Values of Gain Resistors

Desired Gain	1% Std Table Value of R _G , Ω	Calculated Gain
2	51.1 k	1.988
5	12.7 k	4.976
10	5.62 k	9.986
20	2.67 k	19.91
33	1.58 k	32.96
40	1.3 k	39.85
50	1.02 k	50.50
65	787	65.17
100	511	99.83
200	255	199.0
500	102	496.1
1000	51.1	989.3

INPUT AND OUTPUT OFFSET VOLTAGE

The low errors of the AD622 are attributed to two sources, input and output errors. The output error is divided by G when referred to the input. In practice, the input errors dominate at high gains and the output errors dominate at low gains. The total V_{OS} for a given gain is calculated as:

$$\text{Total Error RTI} = \text{input error} + (\text{output error}/G)$$

$$\text{Total Error RTO} = (\text{input error} \times G) + \text{output error}$$

REFERENCE TERMINAL

The reference terminal potential defines the zero output voltage and is especially useful when the load does not share a precise ground with the rest of the system. It provides a direct means of injecting a precise offset to the output, with an allowable range of 2 V within the supply voltages. Parasitic resistance should be kept to a minimum for optimum CMR.

INPUT PROTECTION

The AD622 features 400 Ω of series thin film resistance at its inputs, and will safely withstand input overloads of up to ± 25 V or ± 60 mA for up to an hour. This is true for all gains and power on and off, which is particularly important since the signal source and amplifier may be powered separately. For continuous input overload, the current should not exceed 6 mA ($I_{IN} \leq V_{IN}/400 \Omega$). For input overloads beyond the supplies, clamping the inputs to the supplies (using a diode such as an IN4148) will reduce the required resistance, yielding lower noise.

RF INTERFERENCE

The circuit of Figure 15 is recommended for AD622 series in-amps and provides good RFI suppression at the expense of reducing the (differential) bandwidth. In addition, this RC input network also provides additional input overload protection (see input protection section). Resistors $R1$ and $R2$ were selected to be high enough in value to isolate the circuit's input from capacitors $C1$ – $C3$, but without significantly increasing the circuit's noise.

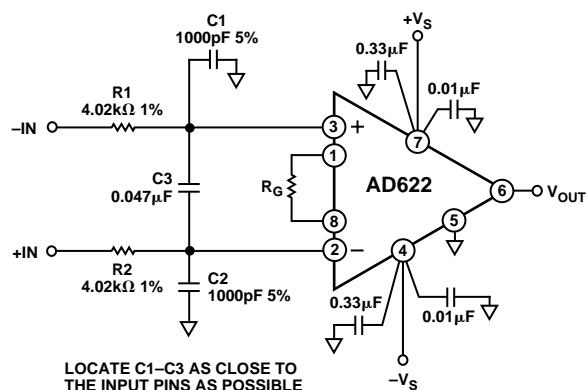

Figure 15. RFI Suppression Circuit for AD622 Series In-Amps

$R1/R2$ and $C1/C2$ form a bridge circuit whose output appears across the in-amp's input pins. Any mismatch between the $C1/R1$ and $C2/R2$ time constant will unbalance the bridge and reduce common-mode rejection. $C3$ insures that any RF signals are common mode (the same on both in-amp inputs) and are not applied differentially.

This low pass network has a -3 dB BW equal to: $1/(2\pi (R1 + R2) (C3 + C1 + C2))$. Using a $C3$ value of 0.047 μF as shown, the -3 dB signal BW of this circuit is approximately 400 Hz.

When operating at a gain of 1000, the typical dc offset shift over a frequency range of 1 Hz to 20 MHz will be less than 1.5 μV RTI and the circuit's RF signal rejection will be better than 71 dB. At a gain of 100, the dc offset shift is well below 1 mV RTI and RF rejection better than 70 dB.

The 3 dB signal bandwidth of this circuit may be increased to 900 Hz by reducing resistors $R1$ and $R2$ to 2.2 k Ω . The performance is similar to that using 4 k Ω resistors, except that the circuitry preceding the in-amp must drive a lower impedance load.

This circuit should be built using a PC board with a ground plane on both sides. All component leads should be made as short as possible. Resistors $R1$ and $R2$ can be common 1% metal film units but capacitors $C1$ and $C2$ need to be $\pm 5\%$ tolerance devices to avoid degrading the circuit's common-mode rejection. Either the traditional 5% silver micas, miniature size micas, or the new Panasonic $\pm 2\%$ PPS film capacitors are recommended.

AD622

GROUNDING

Since the AD622 output voltage is developed with respect to the potential on the reference terminal, it can solve many grounding problems by simply tying the REF pin to the appropriate “local ground.” The REF pin should however be tied to a low impedance point for optimal CMR.

The use of ground planes is recommended to minimize the impedance of ground returns (and hence the size of dc errors). In order to isolate low level analog signals from a noisy digital environment, many data-acquisition components have separate analog and digital ground returns (Figure 16). All ground pins from mixed signal components such as analog to digital converters should be returned through the “high quality” analog ground plane. Maximum isolation between analog and digital is achieved by connecting the ground planes back at the supplies. The digital return currents from the ADC which flow in the analog ground plane will in general have a negligible effect on noise performance.

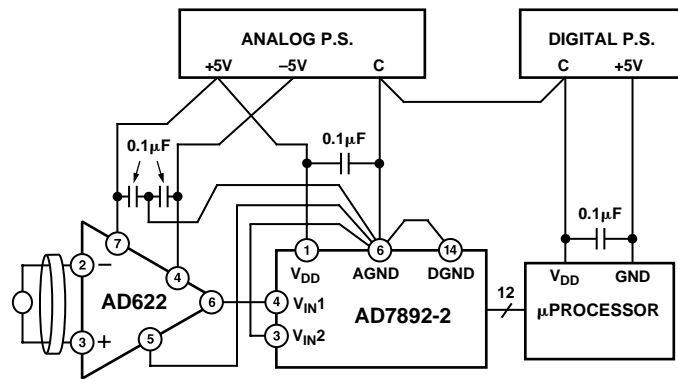

Figure 16. Basic Grounding Practice

GROUND RETURNS FOR INPUT BIAS CURRENTS

Input bias currents are those currents necessary to bias the input transistors of an amplifier. There must be a direct return path for these currents; therefore when amplifying “floating” input sources such as transformers, or ac-coupled sources, there must be a dc path from each input to ground as shown in Figure 17. Refer to the *Instrumentation Amplifier Application Guide* (free from Analog Devices) for more information regarding in amp applications.

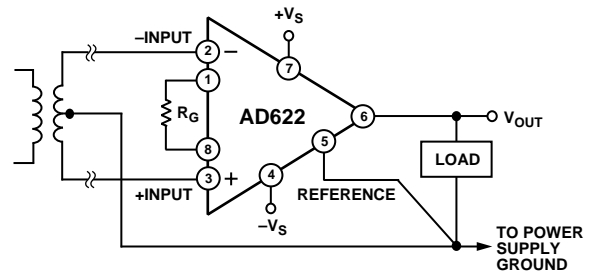

Figure 17a. Ground Returns for Bias Currents with Transformer Coupled Inputs

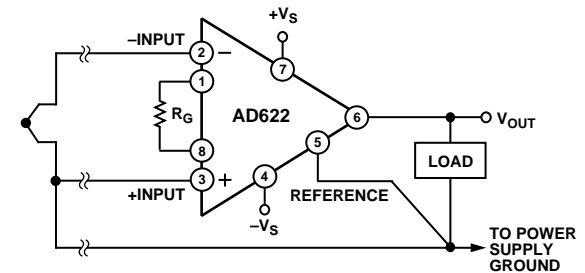

Figure 17b. Ground Returns for Bias Currents with Thermocouple Inputs

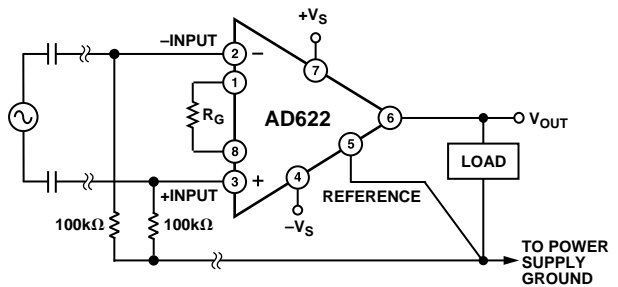
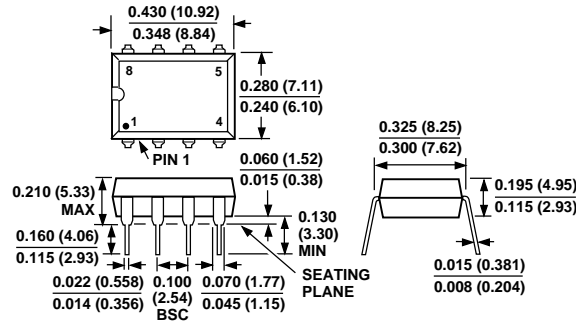

Figure 17c. Ground Returns for Bias Currents with AC Coupled Inputs

OUTLINE DIMENSIONS

Dimensions shown in inches and (mm).

Plastic DIP (N-8) Package



SOIC (SO-8) Package

