

350MHz Fixed Gain Amplifiers with Enable

The EL5106 and EL5306 are fixed gain amplifiers with a bandwidth of 350MHz. This makes these amplifiers ideal for today's high speed video and monitor applications. They feature internal gain setting resistors and can be configured in a gain of +1, -1 or +2.

With a supply current of just 1.5mA and the ability to run from a single supply voltage from 5V to 12V, these amplifiers are also ideal for handheld, portable or battery powered equipment.

The EL5106 and EL5306 also incorporate an enable and disable function to reduce the supply current to 25 μ A typical per amplifier. Allowing the \overline{CE} pin to float or applying a low logic level will enable the amplifier.

The EL5106 is offered in the 6-pin SOT-23 and the industry-standard 8-pin SO packages and the EL5306 is available in the 16-pin SO and 16-pin QSOP packages. All operate over the industrial temperature range of -40°C to +85°C.

Ordering Information

PART NUMBER	PACKAGE	TAPE & REEL	PKG. DWG. #
EL5106IW-T7	6-Pin SOT-23	7" (3K pcs)	MDP0038
EL5106IW-T7A	6-Pin SOT-23	7" (250 pcs)	MDP0038
EL5106IS	8-Pin SO	-	MDP0027
EL5106IS-T7	8-Pin SO	7"	MDP0027
EL5106IS-T13	8-Pin SO	13"	MDP0027
EL5306IS	16-Pin SO (0.150")	-	MDP0027
EL5306IS-T7	16-Pin SO (0.150")	7"	MDP0027
EL5306IS-T13	16-Pin SO (0.150")	13"	MDP0027
EL5306IU	16-Pin QSOP	-	MDP0040
EL5306IU-T7	16-Pin QSOP	7"	MDP0040
EL5306IU-T13	16-Pin QSOP	13"	MDP0040
EL5306IUZ (See Note)	16-Pin QSOP (Pb-free)	-	MDP0040
EL5306IUZ-T7 (See Note)	16-Pin QSOP (Pb-free)	7"	MDP0040
EL5306IUZ-T13 (See Note)	16-Pin QSOP (Pb-free)	13"	MDP0040

NOTE: Intersil Pb-free products employ special Pb-free material sets; molding compounds/die attach materials and 100% matte tin plate termination finish, which is compatible with both SnPb and Pb-free soldering operations. Intersil Pb-free products are MSL classified at Pb-free peak reflow temperatures that meet or exceed the Pb-free requirements of IPC/JEDEC J Std-020B.

Features

- Pb-free Available as an Option
- Gain selectable (+1, -1, +2)
- 350MHz -3dB BW ($A_V = 2$)
- 1.5mA supply current per amplifier
- Fast enable/disable
- Single and dual supply operation, from 5V to 12V
- Available in SOT-23 packages
- 450MHz, 3.5mA product available (EL5108 & EL5308)

Applications

- Battery powered equipment
- Handheld, portable devices
- Video amplifiers
- Cable drivers
- RGB amplifiers

Pinouts

EL5106
(8-PIN SO)
TOP VIEW

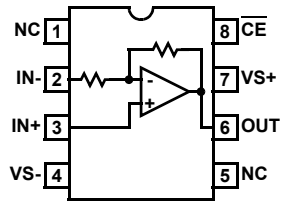

EL5106
(6-PIN SOT-23)
TOP VIEW

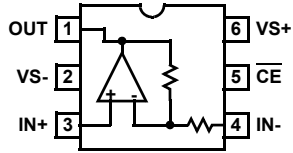

EL5306
(16-PIN SO, QSOP)
TOP VIEW

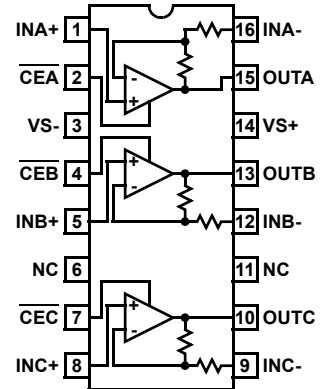

EL5106, EL5306

Absolute Maximum Ratings ($T_A = 25^\circ\text{C}$)

Supply Voltage between V_{S+} and V_{S-} 13.2V
 Maximum Continuous Output Current 50mA
 Operating Junction Temperature 125°C
 Power Dissipation See Curves

Pin Voltages $V_{S-} -0.5\text{V}$ to $V_{S+} +0.5\text{V}$
 Storage Temperature -65°C to $+150^\circ\text{C}$
 Ambient Operating Temperature -40°C to $+85^\circ\text{C}$

CAUTION: Stresses above those listed in "Absolute Maximum Ratings" may cause permanent damage to the device. This is a stress only rating and operation of the device at these or any other conditions above those indicated in the operational sections of this specification is not implied.

IMPORTANT NOTE: All parameters having Min/Max specifications are guaranteed. Typical values are for information purposes only. Unless otherwise noted, all tests are at the specified temperature and are pulsed tests, therefore: $T_J = T_C = T_A$

Electrical Specifications $V_{S+} = +5\text{V}$, $V_{S-} = -5\text{V}$, $R_L = 150\Omega$, $T_A = 25^\circ\text{C}$ unless otherwise specified.

PARAMETER	DESCRIPTION	CONDITIONS	MIN	TYP	MAX	UNIT
AC PERFORMANCE						
BW	-3dB Bandwidth	$A_V = +1$		250		MHz
		$A_V = -1$		380		MHz
		$A_V = +2$		350		MHz
BW1	0.1dB Bandwidth			20		MHz
SR	Slew Rate	$V_O = -2.5\text{V}$ to $+2.5\text{V}$, $A_V = +2$	3000	4500		V/ μs
t_S	0.1% Settling Time	$V_{OUT} = -2.5\text{V}$ to $+2.5\text{V}$, $A_V = 2$		16		ns
e_N	Input Voltage Noise			2.8		nV/ $\sqrt{\text{Hz}}$
i_{N+}	IN+ Input Current Noise			6		pA/ $\sqrt{\text{Hz}}$
dG	Differential Gain Error (Note 1)	$A_V = +2$		0.02		%
dP	Differential Phase Error (Note 1)	$A_V = +2$		0.04		°
DC PERFORMANCE						
V_{OS}	Offset Voltage		-10	1	10	mV
$T_C V_{OS}$	Input Offset Voltage Temperature Coefficient	Measured from T_{MIN} to T_{MAX}		5		$\mu\text{V}/^\circ\text{C}$
A_E	Gain Error	$V_O = -3\text{V}$ to $+3\text{V}$, $R_L = 150\Omega$		1	2.5	%
R_F, R_G	Internal R_F and R_G			325		Ω
INPUT CHARACTERISTICS						
CMIR	Common Mode Input Range		± 3	± 3.3		V
$+I_{IN}$	+ Input Current			1.5	7	μA
R_{IN}	Input Resistance	at I_{N+}		2		M Ω
C_{IN}	Input Capacitance			1		pF
OUTPUT CHARACTERISTICS						
V_O	Output Voltage Swing	$R_L = 150\Omega$ to GND	± 3.4	± 3.6		V
		$R_L = 1\text{k}\Omega$ to GND	± 3.7	± 3.85		V
I_{OUT}	Output Current	$R_L = 10\Omega$ to GND	60	100		mA
SUPPLY						
I_{SON}	Supply Current - Enabled (per amplifier)	No load, $V_{IN} = 0\text{V}$	1.35	1.5	1.82	mA
I_{SOFF}	Supply Current - Disabled (per amplifier)	No load, $V_{IN} = 0\text{V}$		12	25	μA
PSRR	Power Supply Rejection Ratio	DC, $V_S = \pm 4.75\text{V}$ to $\pm 5.25\text{V}$		75		dB
ENABLE						
t_{EN}	Enable Time			280		ns

EL5106, EL5306

Electrical Specifications $V_{S+} = +5V, V_{S-} = -5V, R_L = 150\Omega, T_A = 25^\circ C$ unless otherwise specified. (Continued)

PARAMETER	DESCRIPTION	CONDITIONS	MIN	TYP	MAX	UNIT
t_{DIS}	Disable Time			400		ns
I_{IHCE}	\overline{CE} Pin Input High Current	$\overline{CE} = V_{S+}$	1	5	25	μA
I_{ILCE}	\overline{CE} Pin Input Low Current	$\overline{CE} = V_{S-}$	+1	0	-1	μA
V_{IHCE}	\overline{CE} Input High Voltage for Power-down		$V_{S+} - 1$			V
V_{ILCE}	\overline{CE} Input Low Voltage for Enable				$V_{S+} - 3$	V

NOTE:

- Standard NTSC test, AC signal amplitude = 286mV_{p-p}, f = 3.58MHz

Pin Descriptions

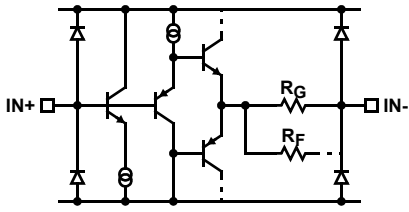
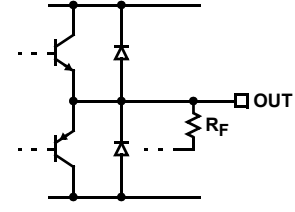
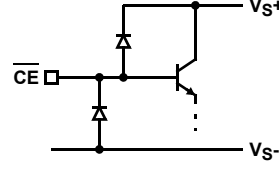
EL5106 (SO8)	EL5106 (SOT23-6)	EL5306 (SO16, QSOP16)	PIN NAME	FUNCTION	EQUIVALENT CIRCUIT
1, 5		6, 11	NC	Not connected	
2	4	9, 12, 16	IN-	Inverting input	 <p style="text-align: center;">CIRCUIT 1</p>
3	3	1, 5, 8	IN+	Non-inverting input	(Reference Circuit 1)
4	2	3	VS-	Negative supply	
6	1	10, 13, 15	OUT	Output	 <p style="text-align: center;">CIRCUIT 2</p>
7	6	14	VS+	Positive supply	
8	5	2, 4, 7	\overline{CE}	Chip enable	 <p style="text-align: center;">CIRCUIT 3</p>

Typical Performance Curves

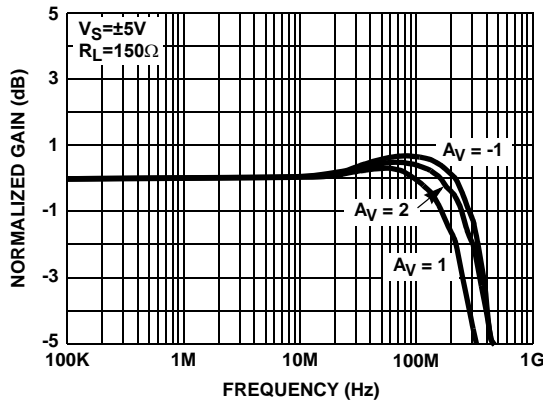

FIGURE 1. FREQUENCY RESPONSE

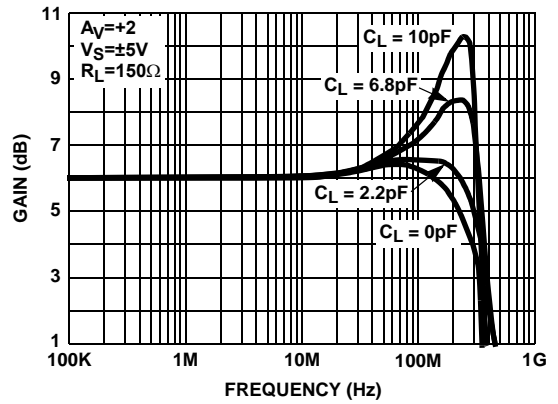

FIGURE 2. FREQUENCY RESPONSE FOR VARIOUS C_L

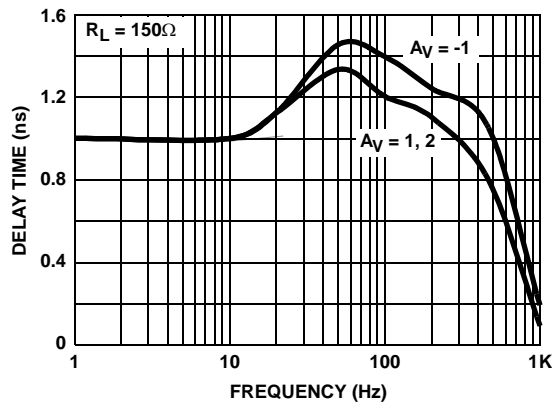

FIGURE 3. GROUP DELAY vs FREQUENCY

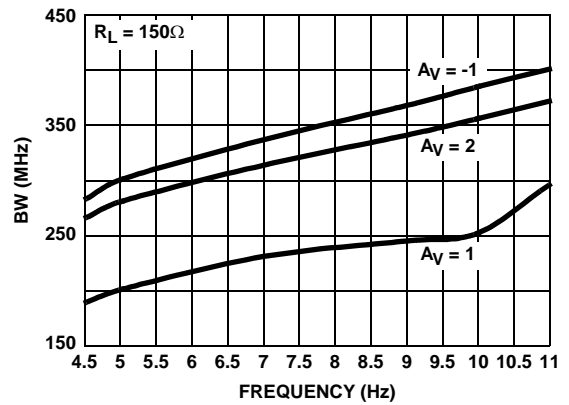

FIGURE 4. BANDWIDTH vs SUPPLY VOLTAGE

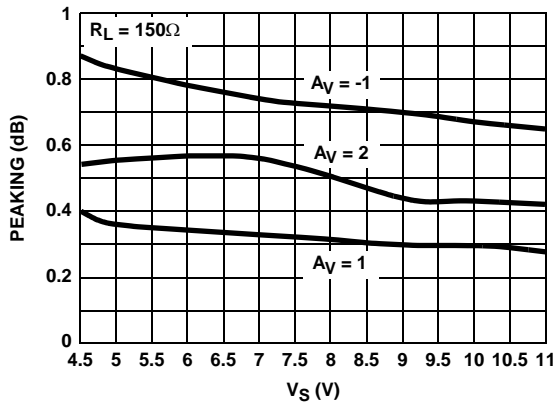

FIGURE 5. PEAKING vs SUPPLY VOLTAGE

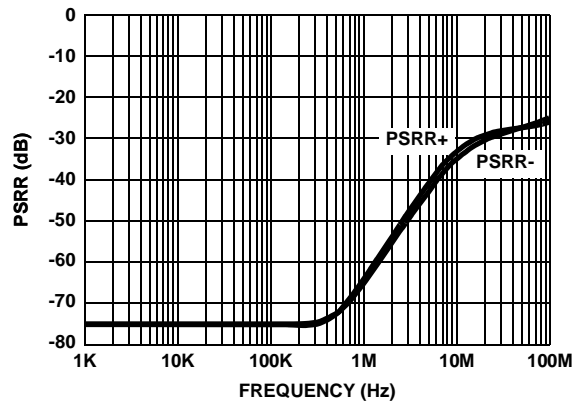

FIGURE 6. POWER SUPPLY REJECTION RATIO vs FREQUENCY

Typical Performance Curves (Continued)

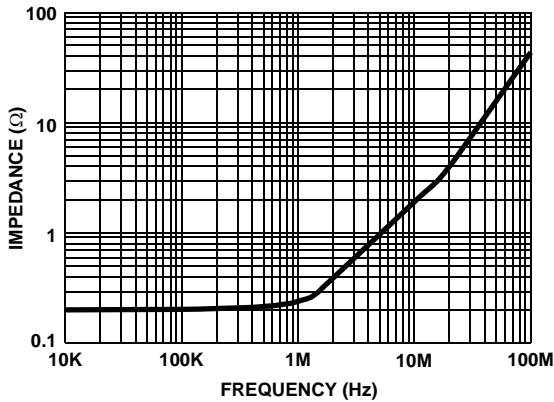

FIGURE 7. OUTPUT IMPEDANCE vs FREQUENCY

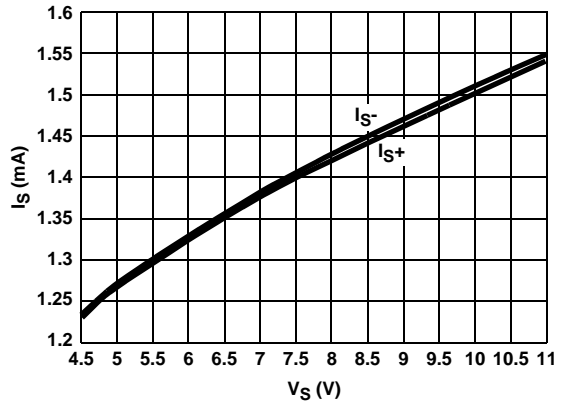

FIGURE 8. SUPPLY CURRENT vs SUPPLY VOLTAGE (PER AMPLIFIER)

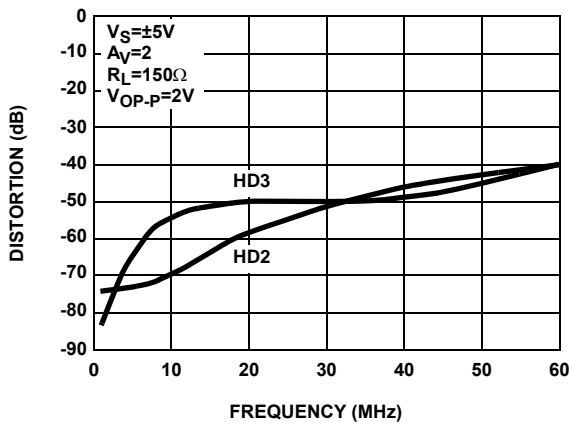

FIGURE 9. HARMONIC DISTORTION vs FREQUENCY

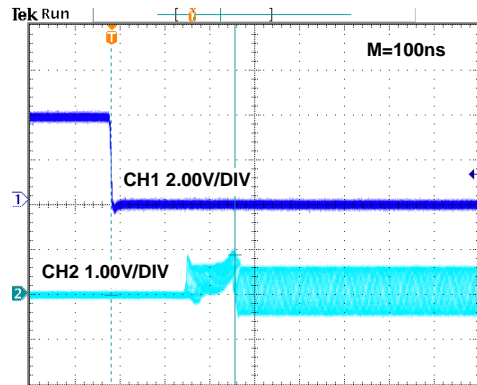

FIGURE 10. ENABLED RESPONSE

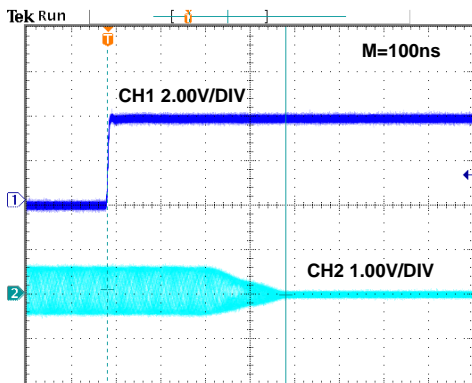

FIGURE 11. DISABLED RESPONSE

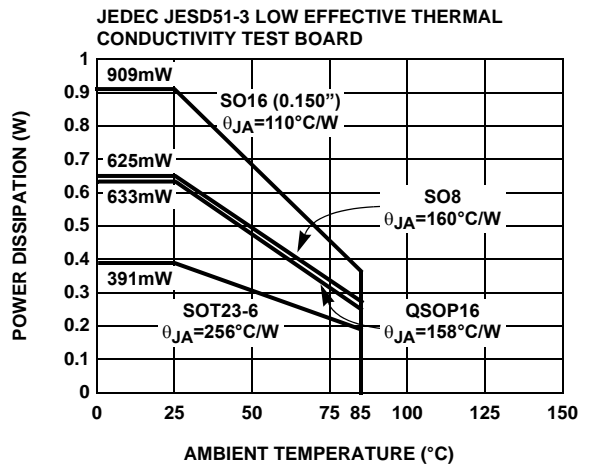

FIGURE 12. PACKAGE POWER DISSIPATION vs AMBIENT TEMPERATURE

Typical Performance Curves (Continued)

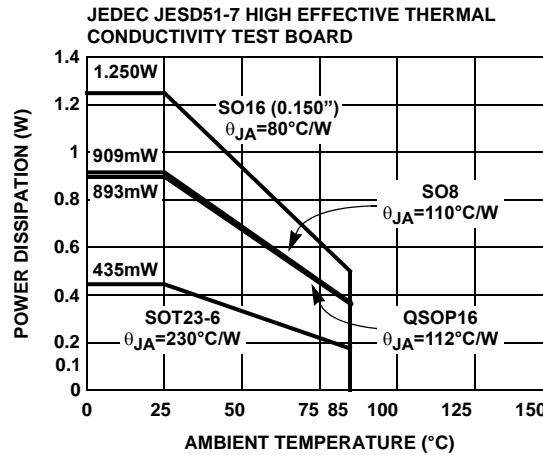

FIGURE 13. PACKAGE POWER DISSIPATION vs AMBIENT TEMPERATURE

Applications Information

Product Description

The EL5106 and EL5306 are fixed gain amplifier that offers a wide -3dB bandwidth of 350MHz and a low supply current of 1.5mA. They work with supply voltages ranging from a single 5V to 12V and they are also capable of swinging to within 1.2V of either supply on the output. These combinations of high bandwidth and low power make the EL5106 and EL5306 the ideal choice for many low-power/high-bandwidth applications such as portable, handheld, or battery-powered equipment.

For varying bandwidth and higher gains, consider the EL5191 with 1GHz on a 9mA supply current or the EL5162 with 300MHz on a 4mA supply current. Versions include single, dual, and triple amp packages with 5-pin SOT-23, 16-pin QSOP, and 8-pin or 16-pin SO outlines.

Power Supply Bypassing and Printed Circuit Board Layout

As with any high frequency device, good printed circuit board layout is necessary for optimum performance. Low impedance ground plane construction is essential. Surface mount components are recommended, but if leaded components are used, lead lengths should be as short as possible. The power supply pins must be well bypassed to reduce the risk of oscillation. The combination of a 4.7µF tantalum capacitor in parallel with a 0.01µF capacitor has been shown to work well when placed at each supply pin.

Disable/Power-Down

The EL5106 and EL5306 amplifiers can be disabled placing their output in a high impedance state. When disabled, the amplifier supply current is reduced to <25µA. The EL5106 and EL5306 are disabled when its \overline{CE} pin is pulled up to within 1V of the positive supply. Similarly, the amplifier is

enabled by floating or pulling the \overline{CE} pin to at least 3V below the positive supply. For ±5V supply, this means that the amplifier will be enabled when \overline{CE} is 2V or less, and disabled when \overline{CE} is above 4V. Although the logic levels are not standard TTL, this choice of logic voltages allow the EL5106 and EL5306 to be enabled by tying \overline{CE} to ground, even in 5V single supply applications. The \overline{CE} pin can be driven from CMOS outputs.

Gain Setting

The EL5106 and EL5306 are built with internal feedback and gain resistors. The internal feedback resistors have equal value; as a result, the amplifier can be configured into gain of +1, -1, and +2 without any external resistors. Figure 13 shows the amplifier in gain of +2 configuration. The gain error is ±2% maximum. Figure 14 shows the amplifier in gain of -1 configuration. For gain of +1, IN+ and IN- should be connected together as shown in Figure 15. This configuration avoids the effects of any parasitic capacitance on the IN- pin. Since the internal feedback and gain resistors change with temperature and process, external resistor should not be used to adjust the gain settings.

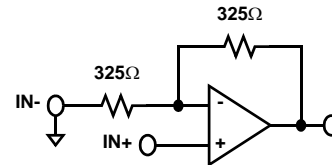

FIGURE 14. $A_V = +2$

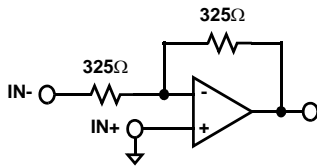

FIGURE 15. $A_V = -1$

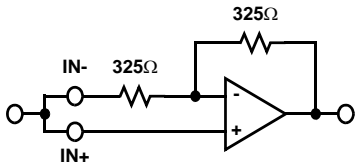

FIGURE 16. $A_V = +1$

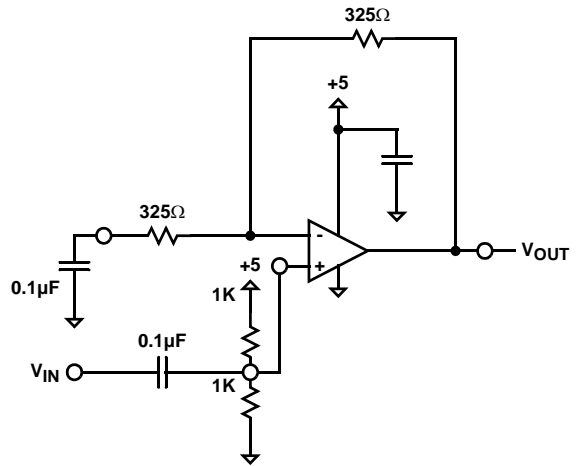

FIGURE 17.

Supply Voltage Range and Single-Supply Operation

The EL5106 and EL5306 have been designed to operate with supply voltages having a span of greater than or equal to 5V and less than 11V. In practical terms, this means that the EL5106 and EL5306 will operate on dual supplies ranging from $\pm 2.5V$ to $\pm 5V$. With single-supply, the EL5106 and EL5306 will operate from 5V to 10V.

As supply voltages continue to decrease, it becomes necessary to provide input and output voltage ranges that can get as close as possible to the supply voltages. The EL5106 and EL5306 have an input range which extends to within 2V of either supply. So, for example, on $\pm 5V$ supplies, the EL5106 and EL5306 have an input range which spans $\pm 3V$. The output range is also quite large, extending to within 1V of the supply rail. On a $\pm 5V$ supply, the output is therefore capable of swinging from $-4V$ to $+4V$. Single-supply output range is larger because of the increased negative swing due to the external pull-down resistor to ground. Figure 16 shows an AC-coupled, gain of +2, +5V single supply circuit configuration.

Video Performance

For good video performance, an amplifier is required to maintain the same output impedance and the same frequency response as DC levels are changed at the output. This is especially difficult when driving a standard video load of 150Ω , because of the change in output current with DC level. Previously, good differential gain could only be achieved by running high idle currents through the output transistors (to reduce variations in output impedance). Special circuitries have been incorporated in the EL5106 and EL5306 to reduce the variation of output impedance with current output. This results in dG and dP specifications of 0.02% and 0.04°, while driving 150Ω at a gain of 2.

Output Drive Capability

In spite of its low 1.5mA of supply current per amplifier, the EL5106 and EL5306 are capable of providing a maximum of $\pm 125mA$ of output current.

Driving Cables and Capacitive Loads

When used as a cable driver, double termination is always recommended for reflection-free performance. For those applications, the back-termination series resistor will decouple the EL5106 and EL5306 from the cable and allow extensive capacitive drive. However, other applications may have high capacitive loads without a back-termination resistor. In these applications, a small series resistor (usually between 5Ω and 50Ω) can be placed in series with the output to eliminate most peaking.

Current Limiting

The EL5106 and EL5306 have no internal current-limiting circuitry. If the output is shorted, it is possible to exceed the Absolute Maximum Rating for output current or power dissipation, potentially resulting in the destruction of the device.

Power Dissipation

With the high output drive capability of the EL5106 and EL5306, it is possible to exceed the 125°C Absolute Maximum junction temperature under certain very high load current conditions. Generally speaking when R_L falls below about 25Ω, it is important to calculate the maximum junction temperature (T_{JMAX}) for the application to determine if power supply voltages, load conditions, or package type need to be modified for the EL5106 and EL5306 to remain in the safe operating area. These parameters are calculated as follows:

$$T_{JMAX} = T_{MAX} + (\theta_{JA} \times n \times PD_{MAX})$$

where:

T_{MAX} = Maximum ambient temperature

θ_{JA} = Thermal resistance of the package

n = Number of amplifiers in the package

PD_{MAX} = Maximum power dissipation of each amplifier in the package

PD_{MAX} for each amplifier can be calculated as follows:

$$PD_{MAX} = (2 \times V_S \times I_{SMAX}) + \left[(V_S - V_{OUTMAX}) \times \frac{V_{OUTMAX}}{R_L} \right]$$

where:

V_S = Supply voltage

I_{SMAX} = Maximum bias supply current

V_{OUTMAX} = Maximum output voltage (required)

R_L = Load resistance

SO Package Outline Drawing

The drawing shows the SO package outline with dimensions A through N. It includes a top view with a seating plane, a side view showing the lead profile with a 45-degree angle, and a detail view of the lead tip. A dimension table and notes are provided below the drawing.

DIMENSION TABLE								
Symbol	SO-8	SO-14	SO16 (0.150")	SO16 (0.300") (SOL-16)	SO20 (SOL-20)	SO24 (SOL-24)	SO28 (SOL-28)	Tolerance
A	0.068	0.068	0.068	0.104	0.104	0.104	0.104	MAX.
A1	0.006	0.006	0.006	0.007	0.007	0.007	0.007	+/- 0.003
A2	0.057	0.057	0.057	0.092	0.092	0.092	0.092	+/- 0.002
b	0.017	0.017	0.017	0.017	0.017	0.017	0.017	+/- 0.003
c	0.009	0.009	0.009	0.011	0.011	0.011	0.011	+/- 0.001
D (1)(3)	0.193	0.341	0.390	0.406	0.504	0.606	0.704	+/- 0.004
E	0.236	0.236	0.236	0.406	0.406	0.406	0.406	+/- 0.008
E1 (2)(3)	0.154	0.154	0.154	0.295	0.295	0.295	0.295	+/- 0.004
e	0.050	0.050	0.050	0.050	0.050	0.050	0.050	Basic
L	0.025	0.025	0.025	0.030	0.030	0.030	0.030	+/- 0.009
L1	0.041	0.041	0.041	0.056	0.056	0.056	0.056	Basic
h	0.013	0.013	0.013	0.020	0.020	0.020	0.020	Reference
N	8	14	16	16	20	24	28	Reference

Notes:
 (1) Plastic or metal protrusions of 0.006" maximum per side are not included.
 (2) Plastic interlead protrusions of 0.010" maximum per side are not included.
 (3) Dimensions "D" and "E1" are measured at Datum Plane "H".
 (4) Dimensioning and tolerancing per ASME Y14.5M-1994.

SOT-23 Package Outline Drawing

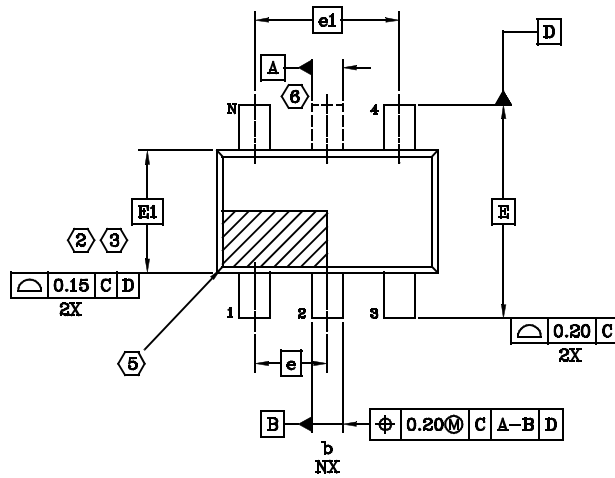

DIMENSION TABLE			
Symbol	SOT23-5	SOT23-6	Tolerance
A	1.45	1.45	MAX.
A1	0.10	0.10	+/- 0.05
A2	1.14	1.14	+/- 0.15
b	0.40	0.40	+/- 0.05
c	0.14	0.14	+/- 0.06
D	2.90	2.90	Basic
E	2.80	2.80	Basic
E1	1.60	1.60	Basic
e	0.95	0.95	Basic
e1	1.90	1.90	Basic
L	0.45	0.45	+/- 0.10
L1	0.80	0.80	Reference
N	5	6	Reference

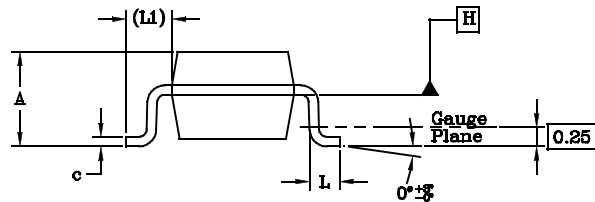
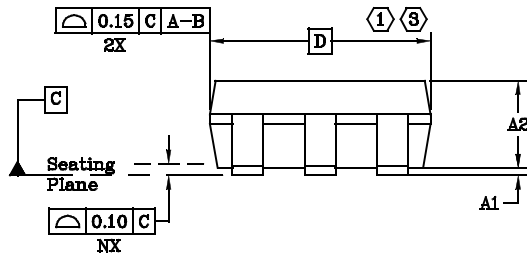

Notes:

- ① Plastic or metal protrusions of 0.25 mm maximum per side are not included.
- ② Plastic interlead protrusions of 0.25 mm maximum per side are not included.
- ③ This dimension is measured at Datum Plane "H".
- ④ Dimensioning and tolerancing per ASME Y14.5M-1994.
- ⑤ Index area - Pin #1 LD. will be located within the indicated zone (SOT23-6 only).
- ⑥ SOT23-5 version has no center lead (shown as a dashed line).

Drawing #: MDP0038
 Rev: E
 Date: 3/13/00
 Units: mm
 JEDEC Reg: MO-178

PACKAGE OUTLINE DRAWING
 SOT-23 PACKAGE FAMILY

elantec Semiconductor, Inc.
 HIGH PERFORMANCE ANALOG INTEGRATED CIRCUITS

QSOP Package Outline Drawing

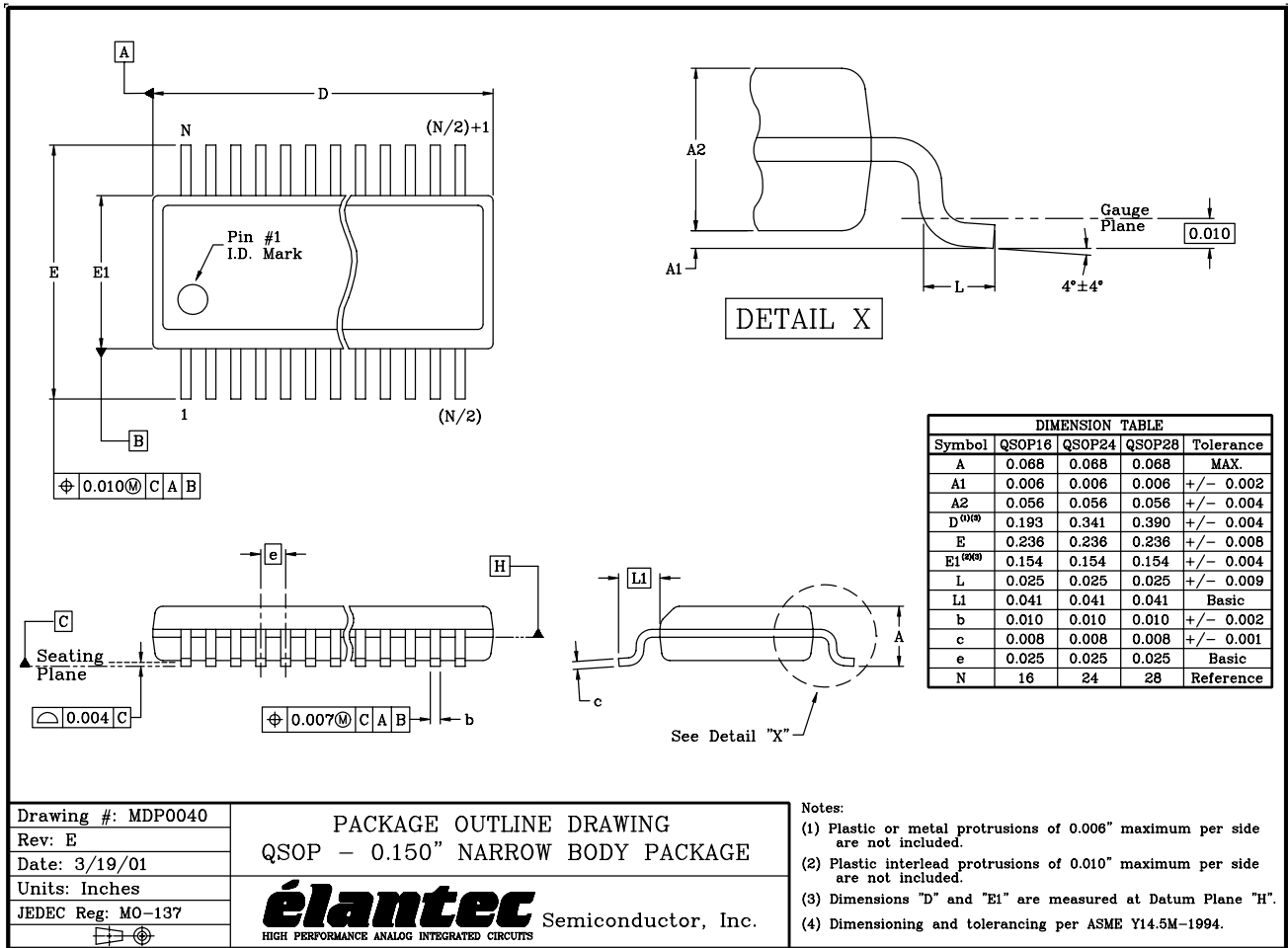

NOTE: The package drawings shown here may not be the latest versions. To check the latest revision, please refer to the Intersil website at <http://www.intersil.com/design/packages/index.asp>

All Intersil U.S. products are manufactured, assembled and tested utilizing ISO9000 quality systems. Intersil Corporation's quality certifications can be viewed at www.intersil.com/design/quality

Intersil products are sold by description only. Intersil Corporation reserves the right to make changes in circuit design, software and/or specifications at any time without notice. Accordingly, the reader is cautioned to verify that data sheets are current before placing orders. Information furnished by Intersil is believed to be accurate and reliable. However, no responsibility is assumed by Intersil or its subsidiaries for its use; nor for any infringements of patents or other rights of third parties which may result from its use. No license is granted by implication or otherwise under any patent or patent rights of Intersil or its subsidiaries.

For information regarding Intersil Corporation and its products, see www.intersil.com