



# STPS1545CT/CF/CG/CFP/CR

## POWER SCHOTTKY RECTIFIER

### MAIN PRODUCT CHARACTERISTICS

$I_{F(AV)}$	2 x 7.5 A
$V_{RRM}$	45 V
$T_j(\text{max})$	175 °C
$V_F(\text{max})$	0.57 V

### FEATURES AND BENEFITS

- VERY SMALL CONDUCTION LOSSES
- NEGLIGIBLE SWITCHING LOSSES
- EXTREMELY FAST SWITCHING
- INSULATED PACKAGE: ISOWATT220AB, TO-220FPAB  
Insulating voltage = 2000V DC  
Capacitance = 12pF
- AVALANCHE CAPABILITY SPECIFIED

### DESCRIPTION

Dual center tap Schottky rectifier suited for SwitchMode Power Supply and high frequency DC to DC converters.

Packaged either in TO-220AB, ISOWATT220AB, TO-220FPAB, D<sup>2</sup>PAK or I<sup>2</sup>PAK, this device is especially intended for use in low voltage, high frequency inverters, free wheeling and polarity protection applications.

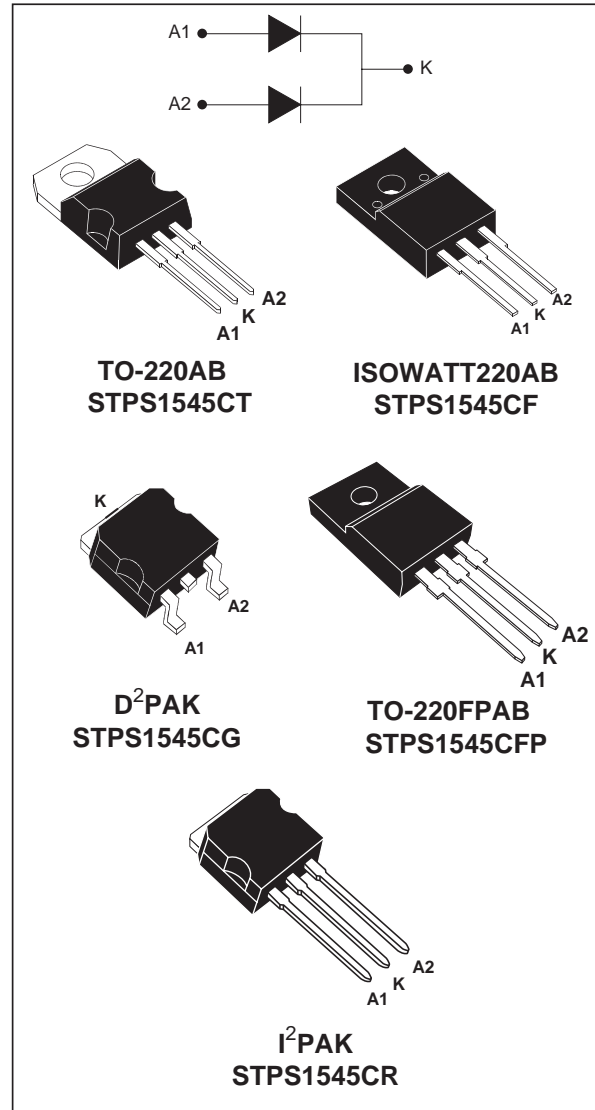

## STPS1545CT/CF/CG/CFP/CR

### ABSOLUTE RATINGS (limiting values, per diode)

Symbol	Parameter				Value	Unit
V <sub>RRM</sub>	Repetitive peak reverse voltage				45	V
I <sub>F(RMS)</sub>	RMS forward current				20	A
I <sub>F(AV)</sub>	Average forward current $\delta = 0.5$	TO-220AB / D <sup>2</sup> PAK / I <sup>2</sup> PAK	T <sub>c</sub> = 157°C	Per diode	7.5	A
		ISOWATT220AB / TO-220FPAB	T <sub>c</sub> = 130°C	Per device	15	
I <sub>FSM</sub>	Surge non repetitive forward current		tp = 10 ms Sinusoidal		150	A
I <sub>RRM</sub>	Repetitive peak reverse current		tp = 2 $\mu$ s square F = 1kHz		1	A
I <sub>RSM</sub>	Non repetitive peak reverse current		tp = 100 $\mu$ s square		2	A
P <sub>ARM</sub>	Repetitive peak avalanche power		tp = 1 $\mu$ s T <sub>j</sub> = 25°C		2700	W
T <sub>stg</sub>	Storage temperature range				-65 to +175	°C
T <sub>j</sub>	Maximum operating junction temperature *				175	°C
dV/dt	Critical rate of rise of reverse voltage				10000	V/ $\mu$ s

\* :  $\frac{dP_{tot}}{dT_j} < \frac{1}{R_{th(j-a)}}$  thermal runaway condition for a diode on its own heatsink

### THERMAL RESISTANCES

Symbol	Parameter			Value	Unit
R <sub>th(j-c)</sub>	Junction to case	TO-220AB / D <sup>2</sup> PAK / I <sup>2</sup> PAK	Per diode	3.0	°C/W
			Total	1.7	
	ISOWATT220AB / TO-220FPAB	Per diode	5.5	Total	
R <sub>th(c)</sub>		TO-220AB / D <sup>2</sup> PAK / I <sup>2</sup> PAK	Coupling	0.35	
		ISOWATT220AB / TO-220FPAB		2.9	

When the diodes 1 and 2 are used simultaneously:

$$\Delta T_j (\text{diode 1}) = P (\text{diode 1}) \times R_{th(j-c)} (\text{per diode}) + P (\text{diode 2}) \times R_{th(c)}$$

### STATIC ELECTRICAL CHARACTERISTICS (Per diode)

Symbol	Parameter	Tests Conditions		Min.	Typ.	Max.	Unit
I <sub>R</sub> *	Reverse leakage current	T <sub>j</sub> = 25°C	V <sub>R</sub> = V <sub>RRM</sub>			100	$\mu$ A
		T <sub>j</sub> = 125°C			5	15	mA
V <sub>F</sub> *	Forward voltage drop	T <sub>j</sub> = 125°C	I <sub>F</sub> = 7.5 A		0.5	0.57	V
		T <sub>j</sub> = 25°C	I <sub>F</sub> = 15 A			0.84	
		T <sub>j</sub> = 125°C	I <sub>F</sub> = 15 A		0.65	0.72	

Pulse test : \* tp = 380  $\mu$ s,  $\delta < 2\%$

To evaluate the conduction losses use the following equation :

$$P = 0.42 \times I_{F(AV)} + 0.020 I_{F(RMS)}^2$$

**Fig. 1:** Average forward power dissipation versus average forward current (per diode).

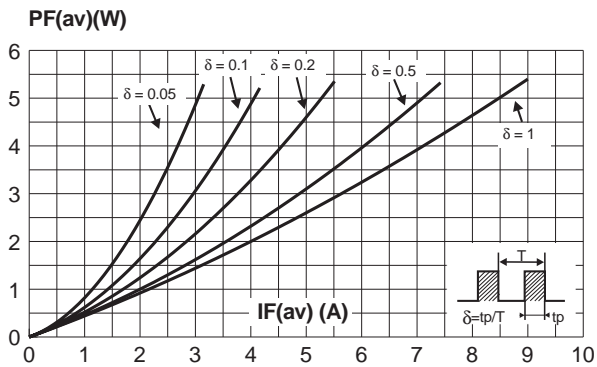

**Fig. 2:** Average current versus ambient temperature ( $\delta = 0.5$ , per diode).

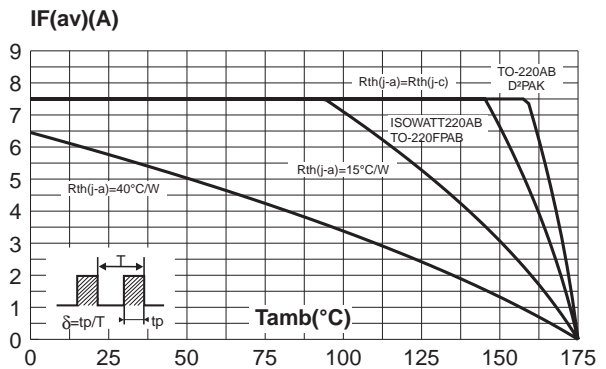

**Fig. 3:** Normalized avalanche power derating versus pulse duration.

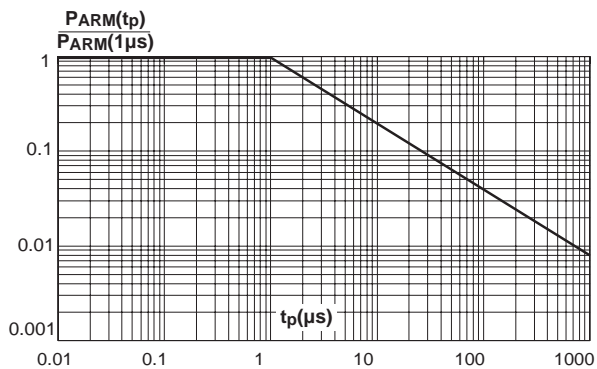

**Fig. 4:** Normalized avalanche power derating versus junction temperature.

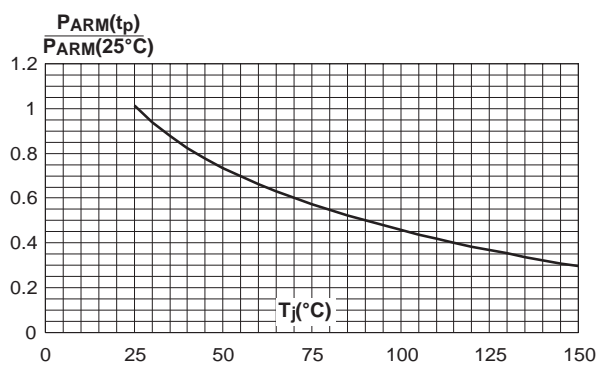

**Fig. 5-1:** Non repetitive surge peak forward current versus overload duration (maximum values, per diode) (TO-220AB and D<sup>2</sup>PAK).

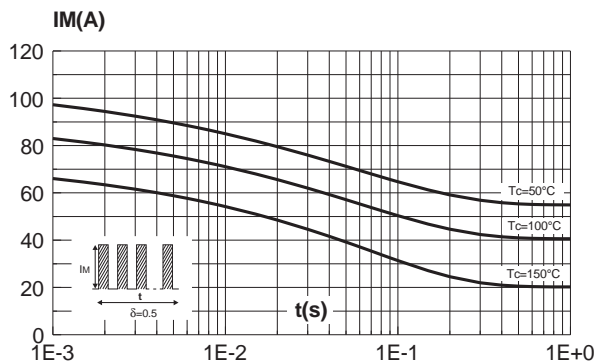

**Fig. 5-2:** Non repetitive surge peak forward current versus overload duration (maximum values, per diode) (ISOWATT220AB, TO-220FPAB).

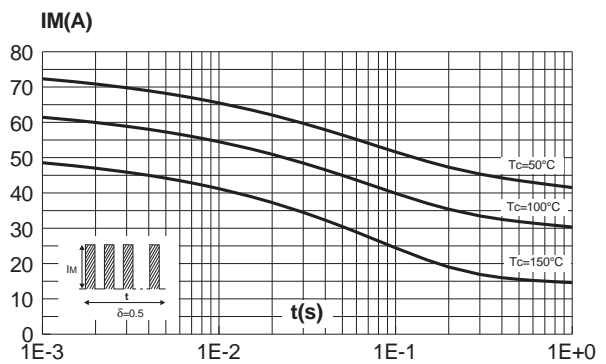

**Fig. 6-1:** Relative variation of thermal transient impedance junction to case versus pulse duration (per diode) (TO-220AB and D<sup>2</sup>PAK).

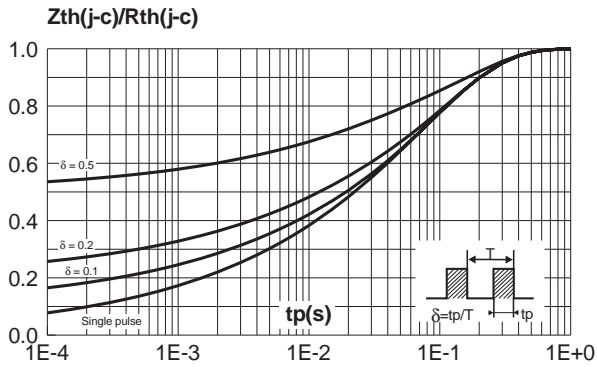

**Fig. 6-2:** Relative variation of thermal transient impedance junction to case versus pulse duration (per diode) (ISOWATT220AB, TO-220FPAB).

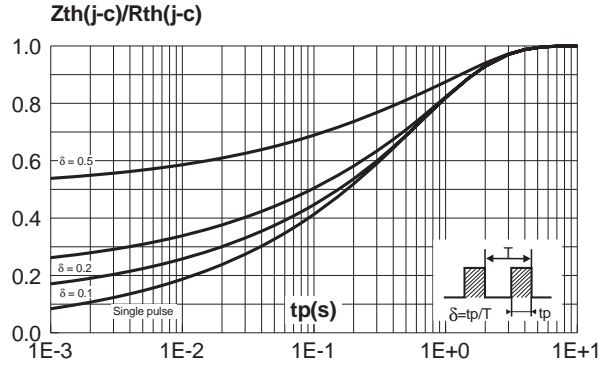

**Fig. 7:** Reverse leakage current versus reverse voltage applied (typical values, per diode).

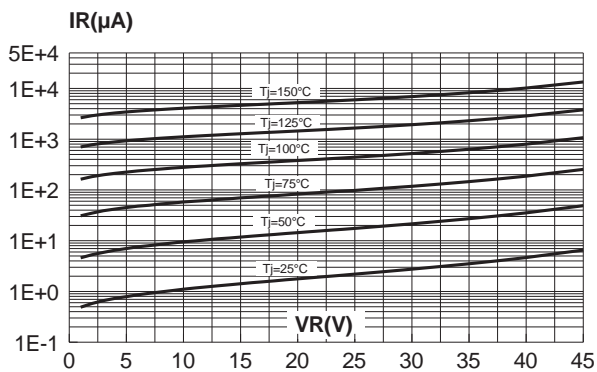

**Fig. 8:** Junction capacitance versus reverse voltage applied (typical values, per diode).

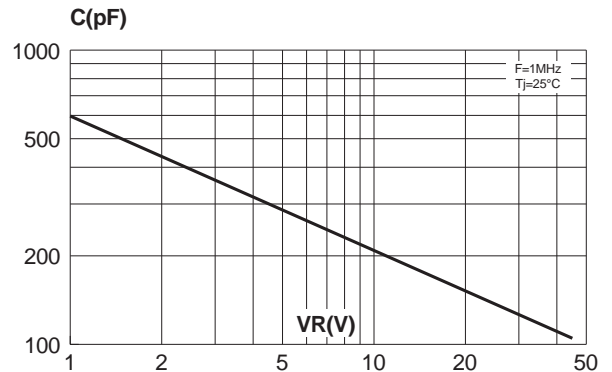

**Fig. 9:** Forward voltage drop versus forward current (maximum values, per diode).

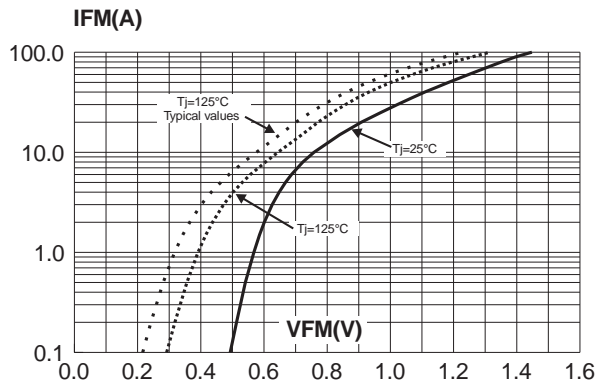

**Fig. 10:** Thermal resistance junction to ambient versus copper surface under tab (Epoxy printed circuit board, copper thickness: 35μm).

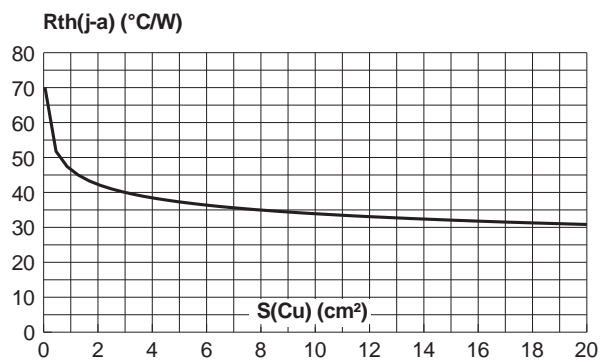

**PACKAGE MECHANICAL DATA**  
D<sup>2</sup>PAK

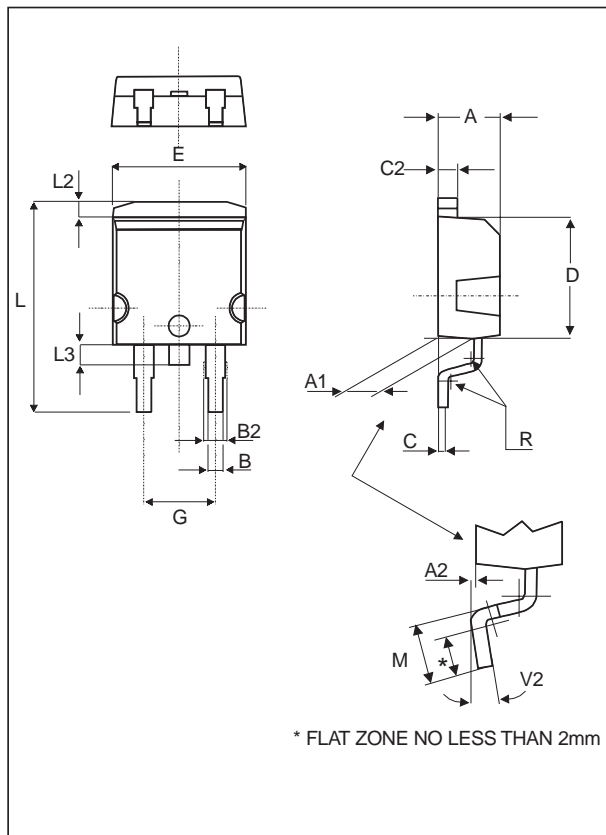

REF.	DIMENSIONS			
	Millimeters		Inches	
	Min.	Max.	Min.	Max.
A	4.40	4.60	0.173	0.181
A1	2.49	2.69	0.098	0.106
A2	0.03	0.23	0.001	0.009
B	0.70	0.93	0.027	0.037
B2	1.14	1.70	0.045	0.067
C	0.45	0.60	0.017	0.024
C2	1.23	1.36	0.048	0.054
D	8.95	9.35	0.352	0.368
E	10.00	10.40	0.393	0.409
G	4.88	5.28	0.192	0.208
L	15.00	15.85	0.590	0.624
L2	1.27	1.40	0.050	0.055
L3	1.40	1.75	0.055	0.069
M	2.40	3.20	0.094	0.126
R	0.40 typ.		0.016 typ.	
V2	0°	8°	0°	8°

**FOOTPRINT DIMENSIONS** (in millimeters)

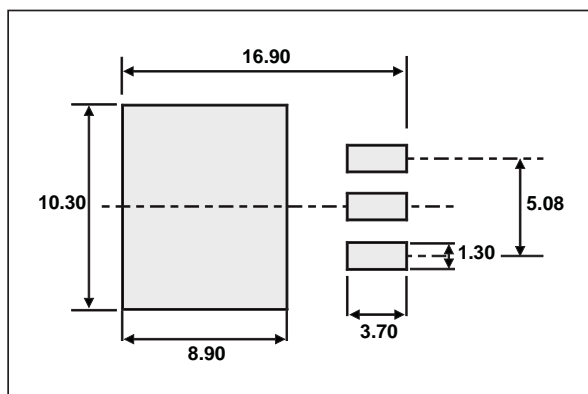

**STPS1545CT/CF/CG/CFP/CR**

**PACKAGE MECHANICAL DATA**  
TO-220AB

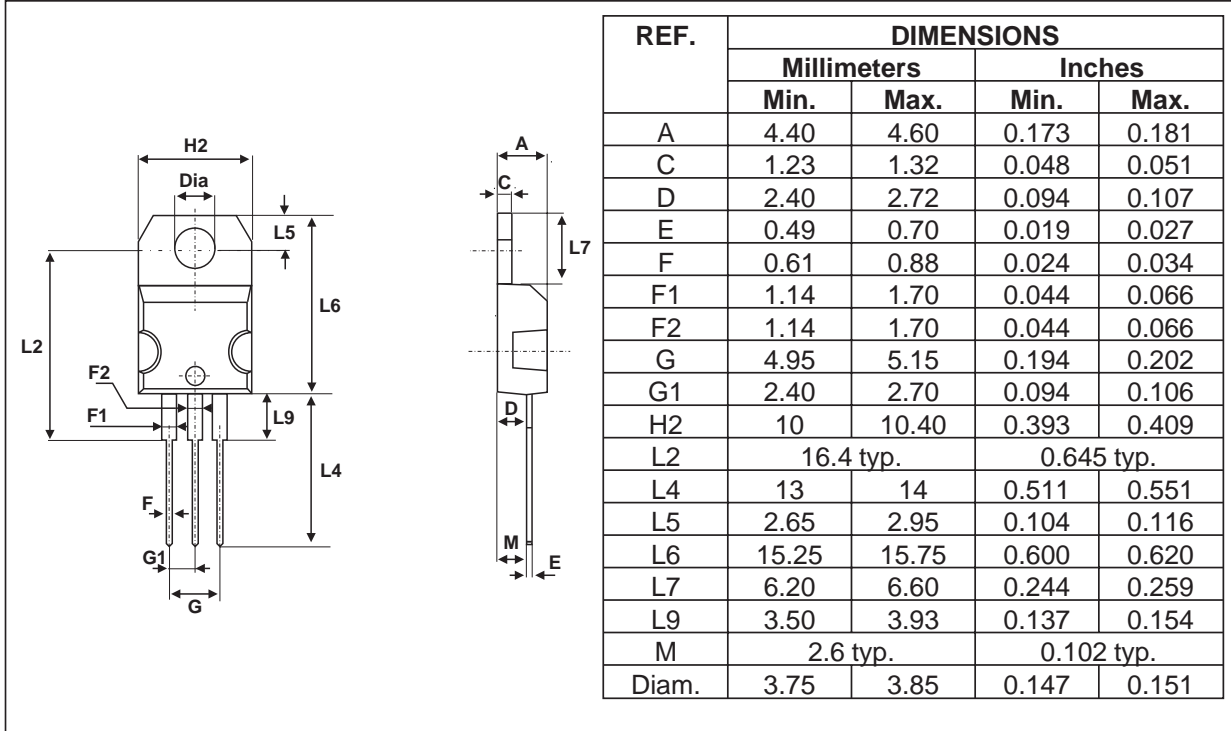

**PACKAGE MECHANICAL DATA**  
TO-220FPAB

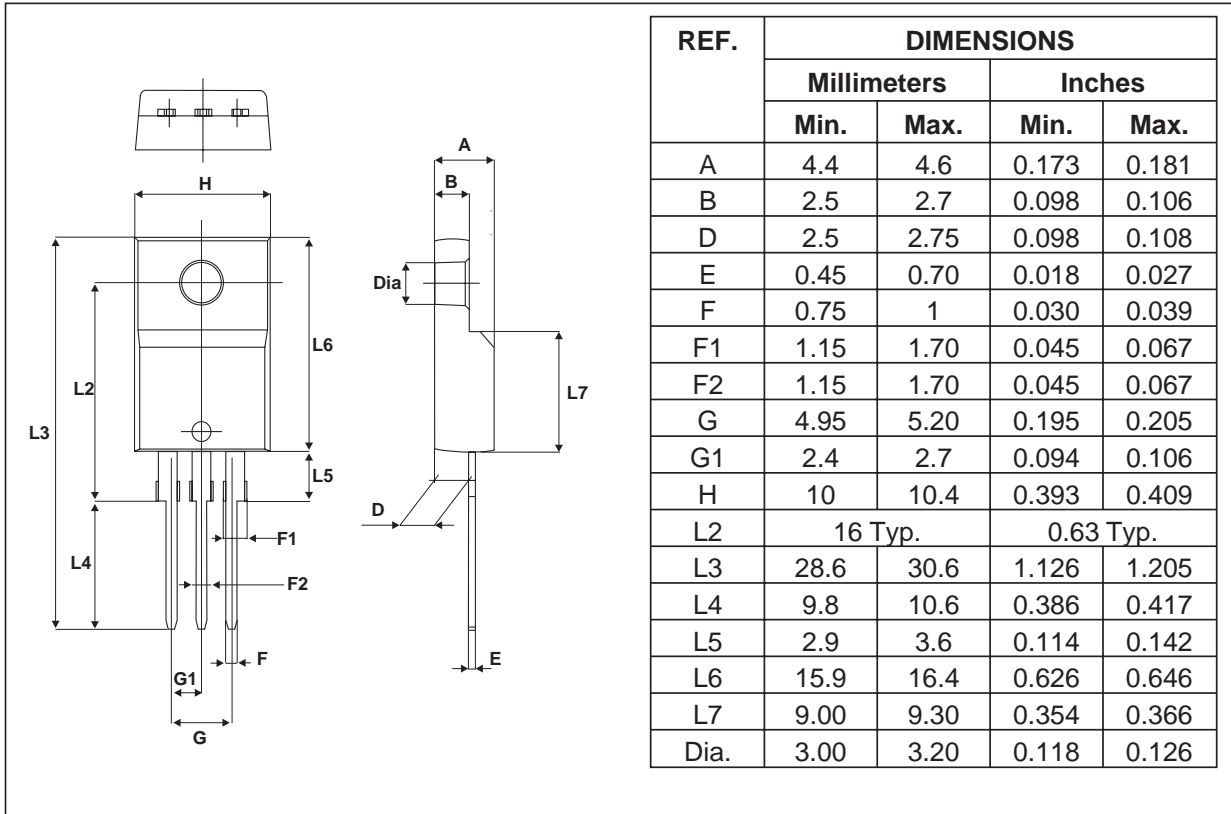

**PACKAGE MECHANICAL DATA**  
 ISOWATT220AB

REF.	DIMENSIONS			
	Millimeters		Inches	
	Min.	Max.	Min.	Max.
A	4.40	4.60	0.173	0.181
B	2.50	2.70	0.098	0.106
D	2.50	2.75	0.098	0.108
E	0.40	0.70	0.016	0.028
F	0.75	1.00	0.030	0.039
F1	1.15	1.70	0.045	0.067
F2	1.15	1.70	0.045	0.067
G	4.95	5.20	0.195	0.205
G1	2.40	2.70	0.094	0.106
H	10.00	10.40	0.394	0.409
L2	16.00 typ.		0.630 typ.	
L3	28.60	30.60	1.125	1.205
L4	9.80	10.60	0.386	0.417
L6	15.90	16.40	0.626	0.646
L7	9.00	9.30	0.354	0.366
Diam	3.00	3.20	0.118	0.126

**STPS1545CT/CF/CG/CFP/CR**

**PACKAGE MECHANICAL DATA**  
I<sup>2</sup>PAK

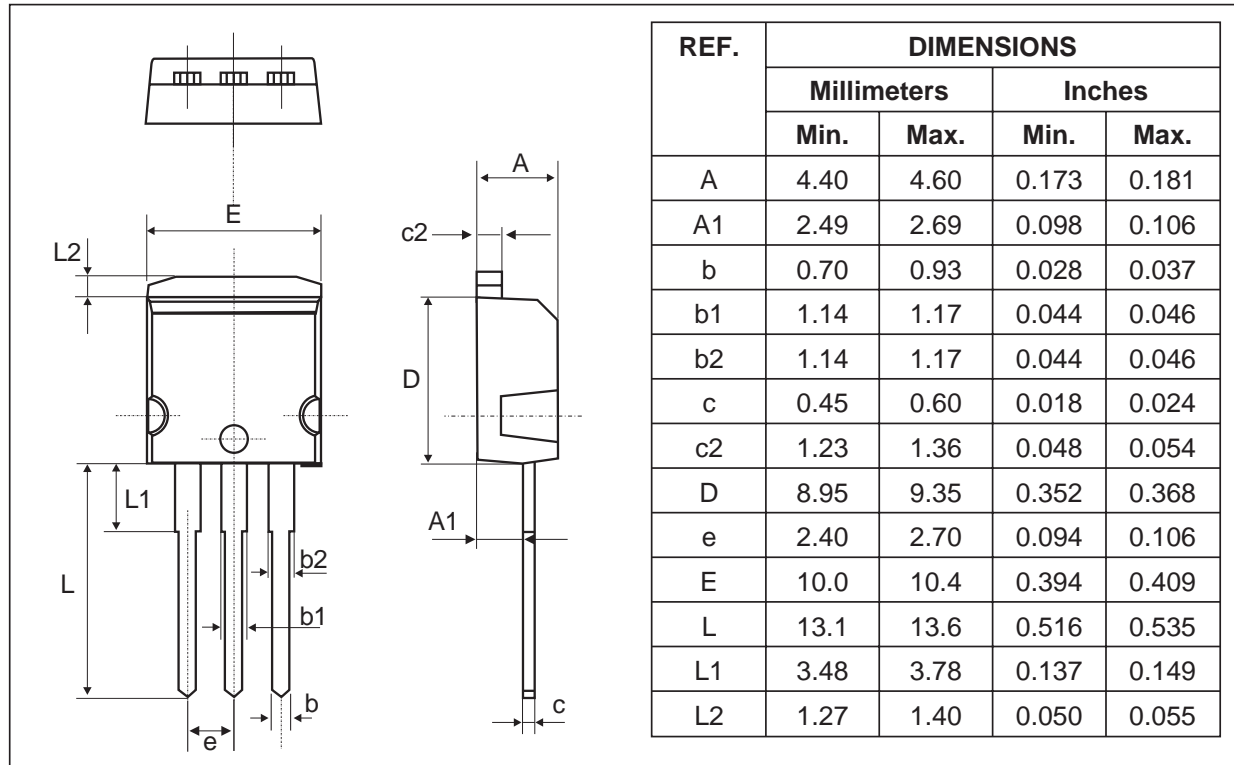

Type	Marking	Package	Weight	Base qty	Delivery mode
STPS1545CT	STPS1545CT	TO-220AB	2.23 g.	50	Tube
STPS1545CF	STPS1545CF	ISOWATT220AB	2.08 g.	50	Tube
STPS1545CFP	STPS1545CFP	TO-220FPAB	2.0 g	50	Tube
STPS1545CG	STPS1545CG	D <sup>2</sup> PAK	1.48 g.	50	Tube
STPS1545CG-TR	STPS1545CG	D <sup>2</sup> PAK	1.48 g.	1000	Tape & reel
STPS1545CR	STPS1545CR	I <sup>2</sup> PAK	1.49 g	50	Tube

- Cooling method: by conduction (C)
- Epoxy meets UL94,V0

Information furnished is believed to be accurate and reliable. However, STMicroelectronics assumes no responsibility for the consequences of use of such information nor for any infringement of patents or other rights of third parties which may result from its use. No license is granted by implication or otherwise under any patent or patent rights of STMicroelectronics. Specifications mentioned in this publication are subject to change without notice. This publication supersedes and replaces all information previously supplied. STMicroelectronics products are not authorized for use as critical components in life support devices or systems without express written approval of STMicroelectronics.

The ST logo is a registered trademark of STMicroelectronics  
 © 2003 STMicroelectronics - Printed in Italy - All rights reserved.  
 STMicroelectronics GROUP OF COMPANIES  
 Australia - Brazil - Canada - China - Finland - France - Germany  
 Hong Kong - India - Israel - Italy - Japan - Malaysia - Malta - Morocco - Singapore  
 Spain - Sweden - Switzerland - United Kingdom - United States.

<http://www.st.com>

