

### FEATURES

- **WIDE BAND OPERATION:**  
IF Input: 3 dB BW: 50 ~ 400 MHz Typical  
RF Output: 3 dB BW: 0.1~2 GHz Typical
- **LOW VOLTAGE OPERATION:** 2.7 V Minimum
- **LOW POWER CONSUMPTION:** 15 mW (UPC8109T)
- **POWER SAVE FUNCTION**
- **SUPER SMALL PACKAGE**
- **TAPE AND REEL PACKAGING OPTION AVAILABLE**

### DESCRIPTION

The UPC8106T and UPC8109T are L-Band Frequency Up-Converters manufactured using the NESAT III MMIC process. The UPC8106T was designed for low distortion while the UPC8109T was designed for low current consumption. Operation from a 3 volt supply voltage makes this device ideal for handheld cellular, PCN and wireless LAN applications.

NEC's stringent quality assurance and test procedures ensure the highest reliability and performance.

### INTERNAL BLOCK DIAGRAM

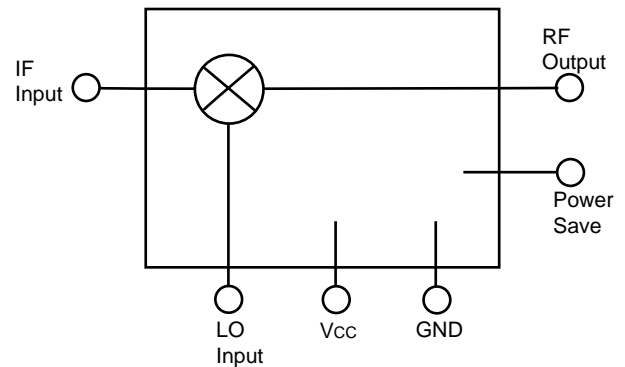

### ELECTRICAL CHARACTERISTICS (TA = 25°C, VCC = 3 V, fIF = 240 MHz, PLO = -5 dBm, VPS ≥ 2.5V)

PART NUMBER PACKAGE OUTLINE			UPC8106T T06			UPC8109T T06		
SYMBOLS	PARAMETERS AND CONDITIONS	UNITS	MIN	TYP	MAX	MIN	TYP	MAX
Icc	Circuit Current, VPS ≥ 2.5 V VPS = 0 V	mA μA	4.5	9	13.5 10	2.5	5	8
CG	Conversion Gain <sup>1</sup> , fRF = 900 MHz fRF = 1.9 GHz	dB dB	7 4	10 7	13 10	4 2	7 5	10 8
NF	Single Standard Noise Figure, fRF = 900 MHz	dB		8.5			8.5	
PSAT	Saturated Output Power <sup>2</sup> , fRF = 900 MHz fRF = 1.9 GHz	dBm dBm	-4 -6.5	-2 -4		-7.5 -10	-6 -8	
OIP3	Output 3rd Order Intercept Point <sup>3</sup> , fRF = 900, 900.4 MHz fRF = 1.9, 1.9004 GHz	dBm dBm		+7 +6.5			+5 +1.5	
RTH (J-A)	Thermal Resistance (Junction to Ambient) Free Air Mounted on a 50 x 50 x 1.6 mm epoxy glass PWB	°C/W °C/W			620 230			620 230

Notes:

1. PIF = -30 dBm.
2. PIF = -10 dBm.
3. fIF1 = 240.0 MHz, fIF2 = 240.4 MHz

# UPC8106T, UPC8109T

## ABSOLUTE MAXIMUM RATINGS<sup>1</sup> (T<sub>A</sub> = 25°C)

SYMBOLS	PARAMETERS	UNITS	RATINGS
V <sub>CC</sub>	Supply Voltage	V	6.0
V <sub>PS</sub>	Power Save Voltage	V	6.0
P <sub>T</sub>	Total Power Dissipation <sup>2</sup>	mW	280
T <sub>OP</sub>	Operating Temperature	°C	-40 to +85
T <sub>STG</sub>	Storage Temperature	°C	-55 to +150

### Notes:

- Operation in excess of any one of these parameters may result in permanent damage.
- Mounted on a 50 x 50 x 1.6 mm epoxy glass PWB (T<sub>A</sub> = +85°C).

## RECOMMENDED OPERATING CONDITIONS

SYMBOLS	PARAMETERS	UNITS	MIN	TYP	MAX
V <sub>CC</sub>	Supply Voltage	V	2.7	3.0	5.5
T <sub>OP</sub>	Operating Temperature	°C	-40	+25	+85
P <sub>LO</sub>	LO Input Level	dBm	-10	-5	0

## TEST CIRCUIT

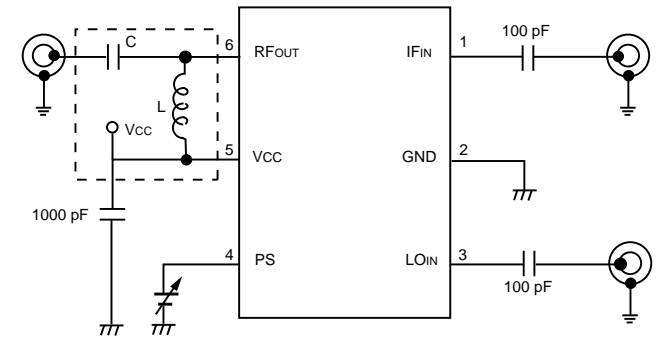

Recommended Values	900 MHz	1.9 GHz
C	1.0 pF	1.8 pF
L	8.2 nH	18 nH

## TYPICAL PERFORMANCE CURVES (T<sub>A</sub> = 25°C unless otherwise specified)

CURRENT vs. VOLTAGE

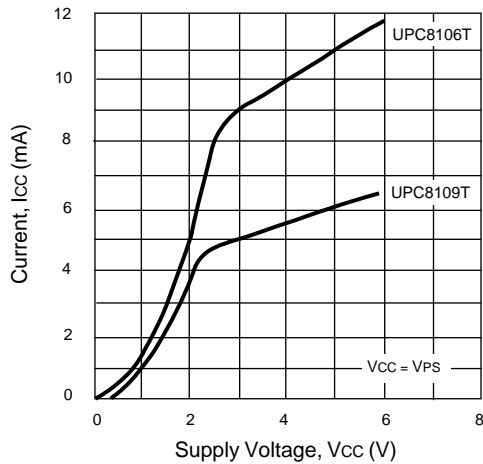

CURRENT vs. TEMPERATURE

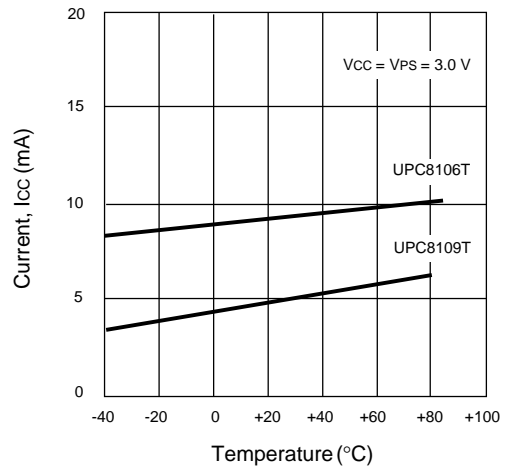

UPC8106T CURRENT vs. POWER SAVE PIN INPUT VOLTAGE

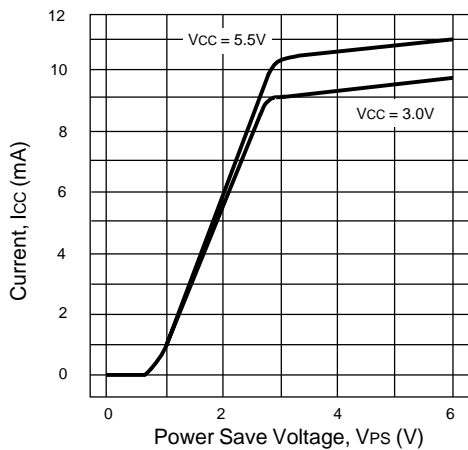

UPC8109T CURRENT vs. POWER SAVE PIN INPUT VOLTAGE

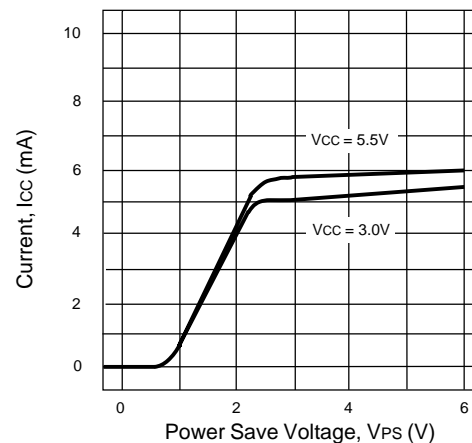

TYPICAL PERFORMANCE CURVES (TA = 25°C)

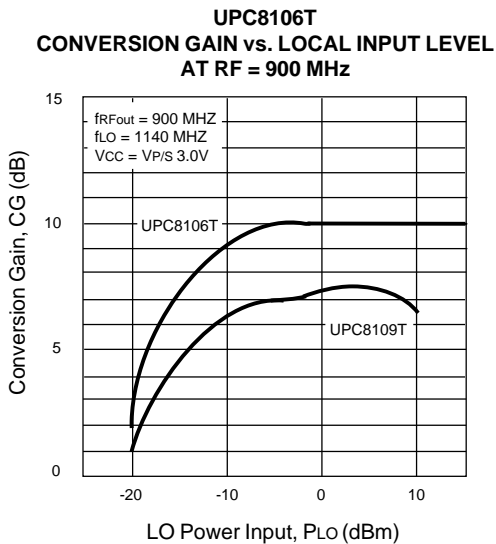
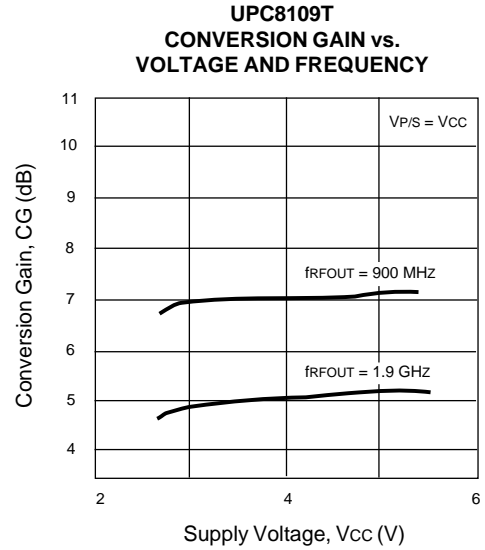
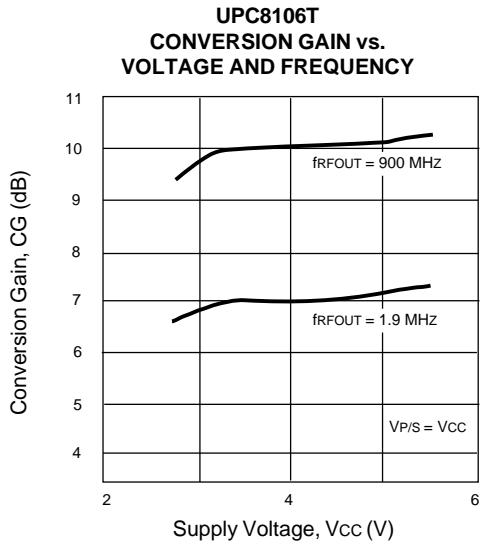
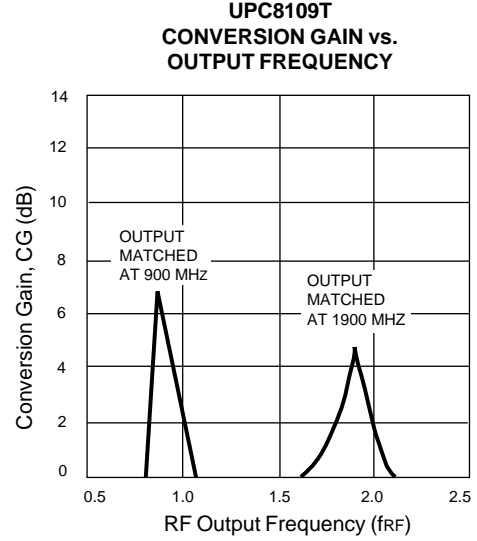
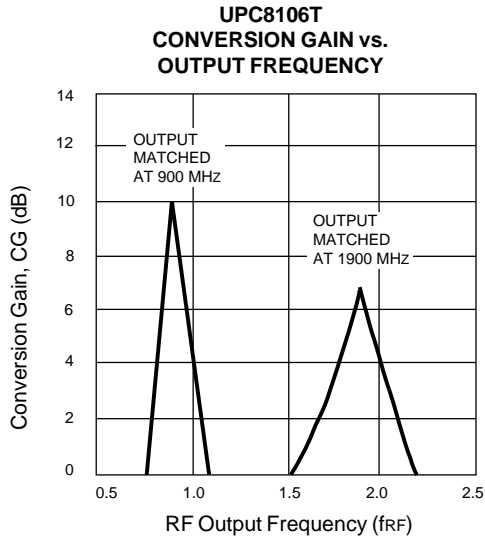

**S11 - RF OUTPUT PORT**

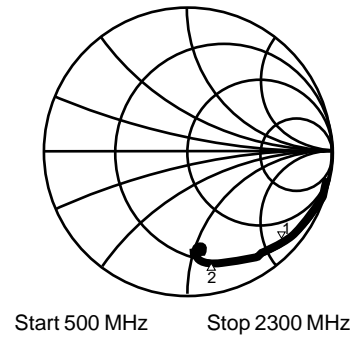

2: 13.845 Ω    -77.34 Ω    1.0850 pF  
 1: 20.633 Ω    -144.74 Ω    1.2218 pF  
 Marker 1 - 900 MHz  
 Marker 2 - 1.9 GHz

TYPICAL PERFORMANCE CURVES (TA = 25°C)

S11 - LO INPUT PORT

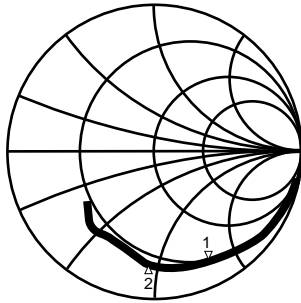

Start 0.3 MHz Stop 3000 MHz

2: 12.050 Ω -45.695 Ω 2.1780 pF  
 1: 13.961 Ω -76.158 Ω 1.8332 pF  
 Marker 1 - 1.14 GHz  
 Marker 2 - 1.66 GHz

S11 - IF INPUT PORT

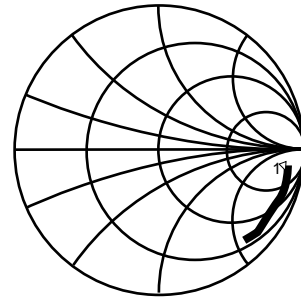

Start 50 MHz Stop 1000 MHz

1: 154.64 Ω -494.41 Ω 1.2876 pF  
 Marker 1 - 250 MHz

OUTLINE DIMENSIONS (Units in mm)

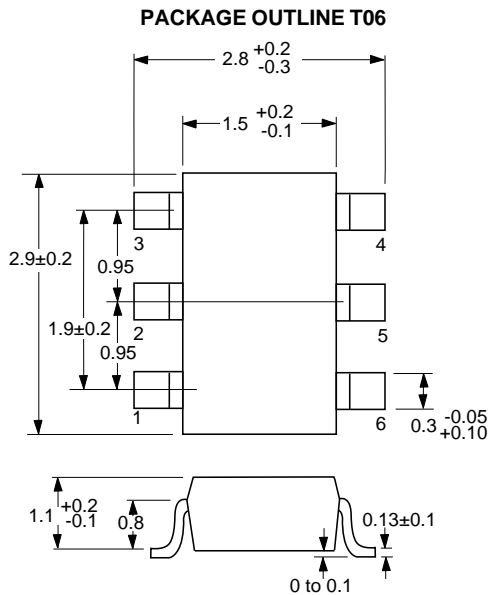

Note:  
 All dimensions are typical unless otherwise specified.

ORDERING INFORMATION

PART NUMBER	QTY
UPC8106T-E3	3K/Reel
UPC8109T-E3	3K/Reel

Note:  
 Embossed Tape, 8 mm wide,  
 Pins 1, 2, 3 are in tape pull-out direction.

RECOMMENDED P.C.B. LAYOUT (Units in mm)

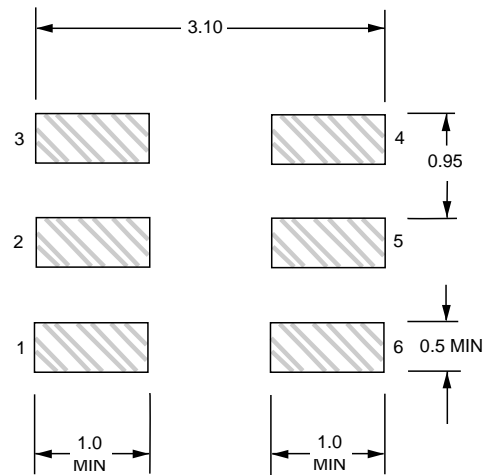

LEAD CONNECTIONS

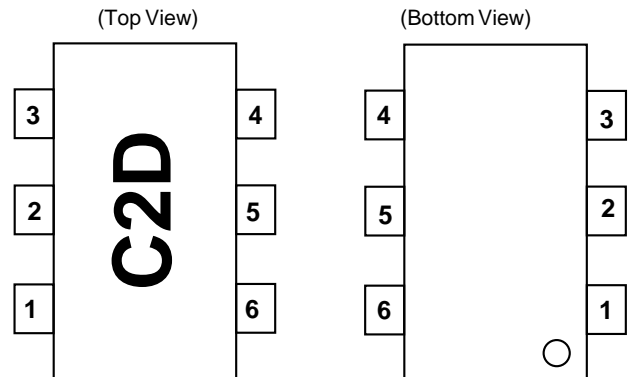

1. IF INPUT
2. GND
3. LO INPUT
4. POWER SAVE
5. Vcc
6. RF OUTPUT

Note: Package Markings  
 C2D: UPC8106T  
 C2G: UPC8109T

EXCLUSIVE NORTH AMERICAN AGENT FOR **NEC** RF, MICROWAVE & OPTOELECTRONIC SEMICONDUCTORS

**CEL** CALIFORNIA EASTERN LABORATORIES • Headquarters • 4590 Patrick Henry Drive • Santa Clara, CA 95054-1817 • (408) 988-3500 • Telex 34-6393 • FAX (408) 988-0279  
 24-Hour Fax-On-Demand: 800-390-3232 (U.S. and Canada only) • Internet: <http://WWW.CEL.COM>

DATA SUBJECT TO CHANGE WITHOUT NOTICE

PRINTED IN USA ON RECYCLED PAPER -1/97