

MITSUBISHI Nch POWER MOSFET

FS10KM-14A

HIGH-SPEED SWITCHING USE

FS10KM-14A



- V_{DSS} 700V
- $r_{DS(ON)}$ (MAX) 1.3Ω
- I_D 10A
- V_{iso} 2000V

OUTLINE DRAWING

Dimensions in mm

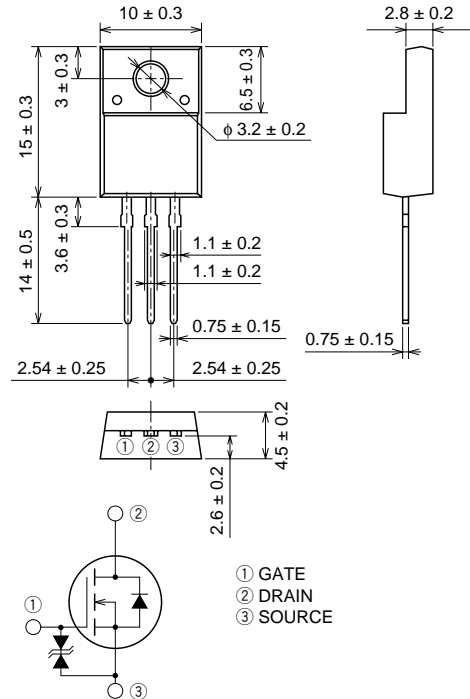

TO-220FN

APPLICATION

SMPS, DC-DC Converter, battery charger, power supply of printer, copier, HDD, FDD, TV, VCR, personal computer etc.

MAXIMUM RATINGS (T_c = 25°C)

Symbol	Parameter	Conditions	Ratings	Unit
V_{DSS}	Drain-source voltage	$V_{GS} = 0V$	700	V
V_{GSS}	Gate-source voltage	$V_{DS} = 0V$	± 30	V
I_D	Drain current		10	A
I_{DM}	Drain current (Pulsed)		30	A
P_D	Maximum power dissipation		40	W
T_{ch}	Channel temperature		-55 ~ +150	°C
T_{stg}	Storage temperature		-55 ~ +150	°C
V_{iso}	Isolation voltage	AC for 1 minute, Terminal to case	2000	V _{rms}
—	Weight	Typical value	2	g

Feb.1999

FS10KM-14A

HIGH-SPEED SWITCHING USE

ELECTRICAL CHARACTERISTICS (T_{ch} = 25°C)

Symbol	Parameter	Test conditions	Limits			Unit
			Min.	Typ.	Max.	
V (BR) DSS	Drain-source breakdown voltage	I _D = 1mA, V _{GS} = 0V	700	—	—	V
V (BR) GSS	Gate-source breakdown voltage	I _{GS} = ±100μA, V _{DS} = 0V	±30	—	—	V
I _{GSS}	Gate-source leakage current	V _{GS} = ±25V, V _{DS} = 0V	—	—	±10	μA
I _{DSS}	Drain-source leakage current	V _{DS} = 700V, V _{GS} = 0V	—	—	1	mA
V _{GS} (th)	Gate-source threshold voltage	I _D = 1mA, V _{DS} = 10V	2	3	4	V
r _{DS} (ON)	Drain-source on-state resistance	I _D = 5A, V _{GS} = 10V	—	1.0	1.3	Ω
V _{DS} (ON)	Drain-source on-state voltage	I _D = 5A, V _{GS} = 10V	—	5.0	6.5	V
y _{fs}	Forward transfer admittance	I _D = 5A, V _{DS} = 10V	4.8	8.0	—	S
C _{iss}	Input capacitance	V _{DS} = 25V, V _{GS} = 0V, f = 1MHz	—	1380	—	pF
C _{oss}	Output capacitance		—	150	—	pF
C _{rss}	Reverse transfer capacitance		—	32	—	pF
t _d (on)	Turn-on delay time	V _{DD} = 200V, I _D = 5A, V _{GS} = 10V, R _{GEN} = R _{GS} = 50Ω	—	25	—	ns
t _r	Rise time		—	33	—	ns
t _d (off)	Turn-off delay time		—	170	—	ns
t _f	Fall time		—	55	—	ns
V _{SD}	Source-drain voltage	I _S = 5A, V _{GS} = 0V	—	1.0	1.5	V
R _{th} (ch-c)	Thermal resistance	Channel to case	—	—	3.13	°C/W

PERFORMANCE CURVES

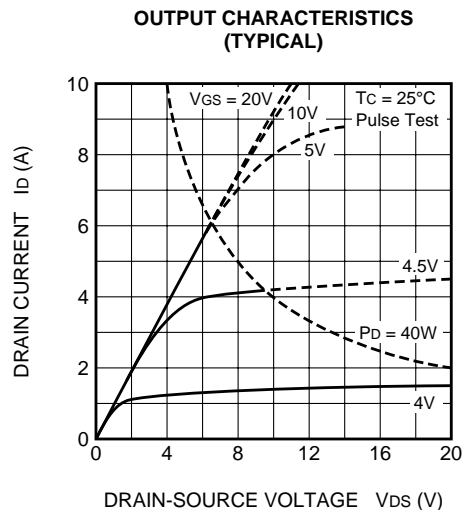
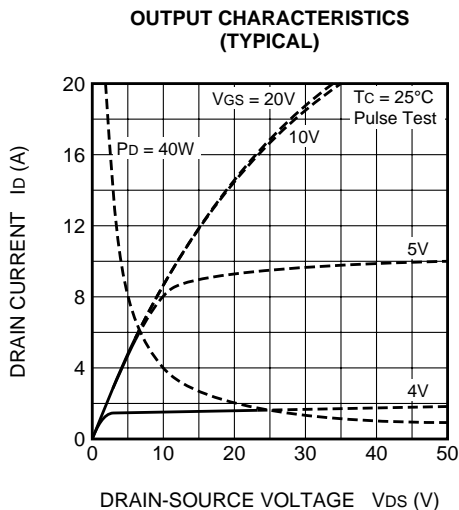
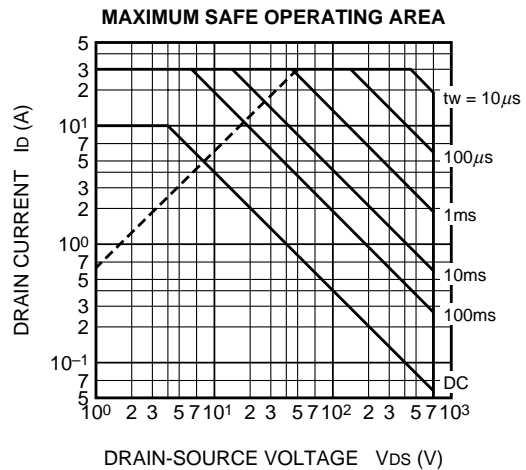
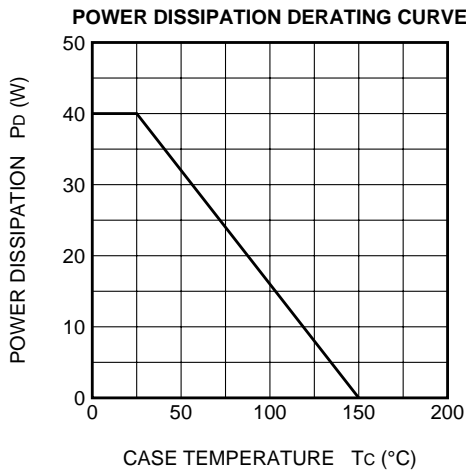

FS10KM-14A

HIGH-SPEED SWITCHING USE

ON-STATE VOLTAGE VS. GATE-SOURCE VOLTAGE (TYPICAL)

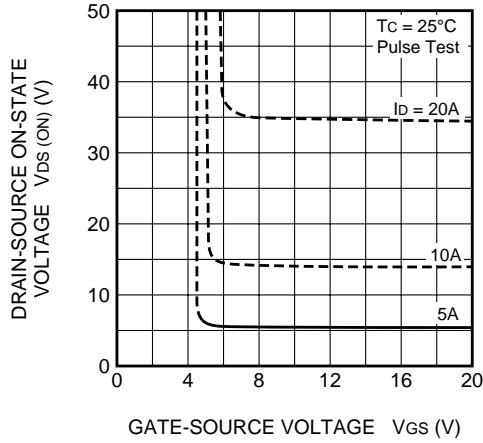

ON-STATE RESISTANCE VS. DRAIN CURRENT (TYPICAL)

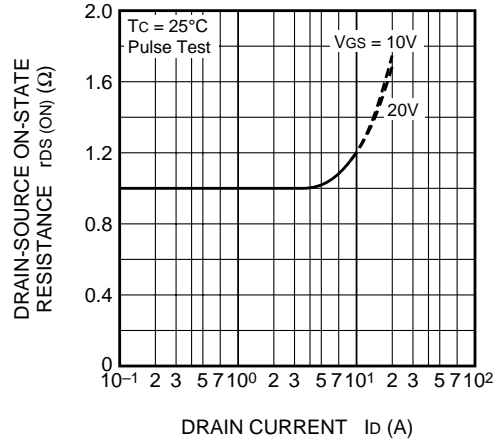

TRANSFER CHARACTERISTICS (TYPICAL)

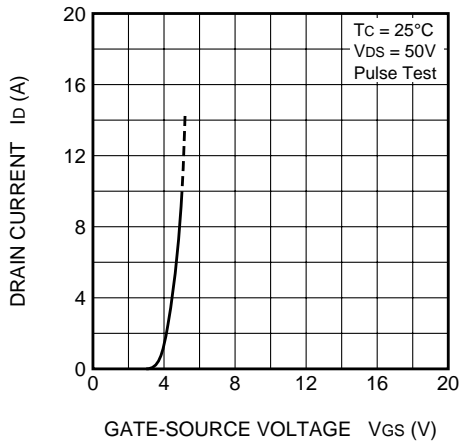

FORWARD TRANSFER ADMITTANCE VS. DRAIN CURRENT (TYPICAL)

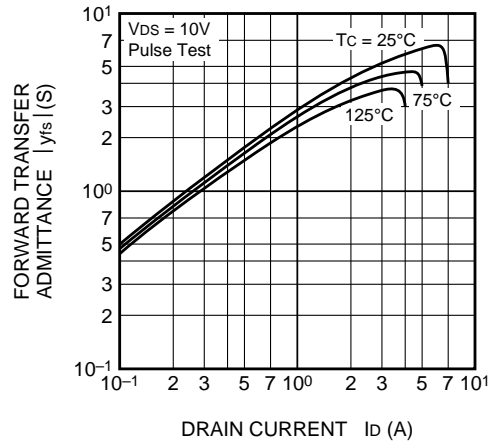

CAPACITANCE VS. DRAIN-SOURCE VOLTAGE (TYPICAL)

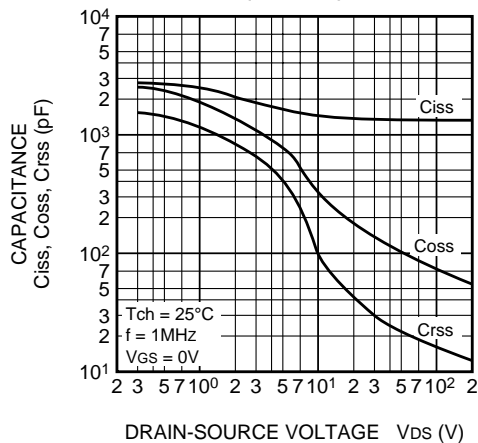

SWITCHING CHARACTERISTICS (TYPICAL)

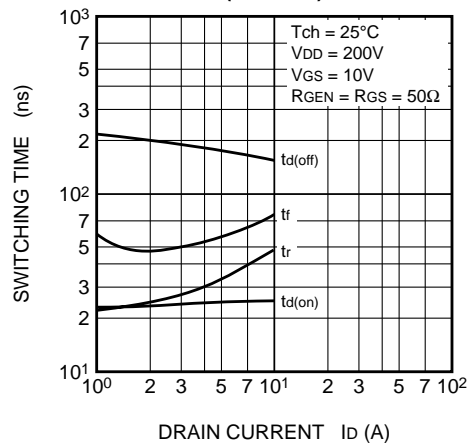

FS10KM-14A

HIGH-SPEED SWITCHING USE

GATE-SOURCE VOLTAGE VS. GATE CHARGE (TYPICAL)

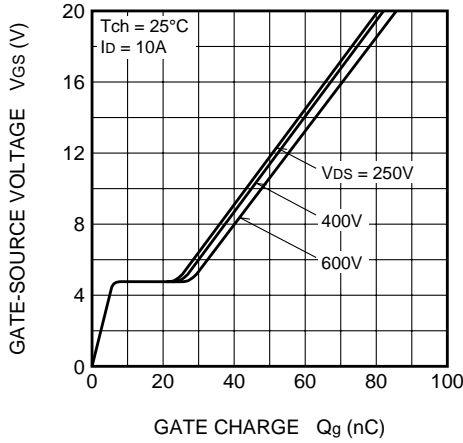

SOURCE-DRAIN DIODE FORWARD CHARACTERISTICS (TYPICAL)

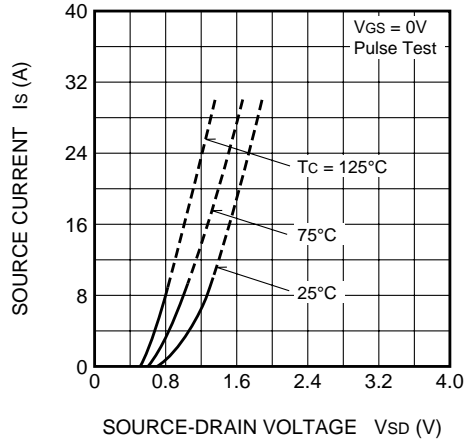

ON-STATE RESISTANCE VS. CHANNEL TEMPERATURE (TYPICAL)

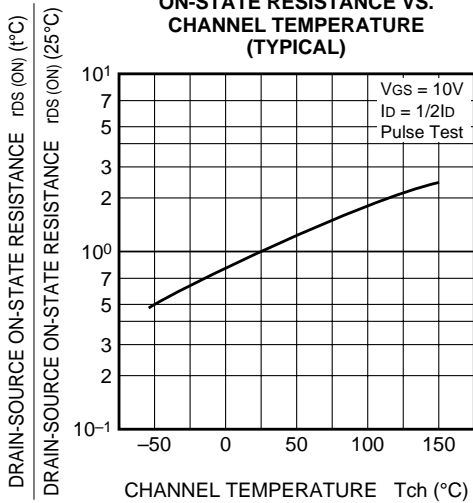

THRESHOLD VOLTAGE VS. CHANNEL TEMPERATURE (TYPICAL)

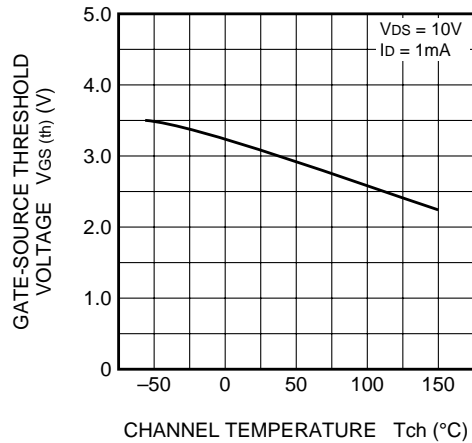

BREAKDOWN VOLTAGE VS. CHANNEL TEMPERATURE (TYPICAL)

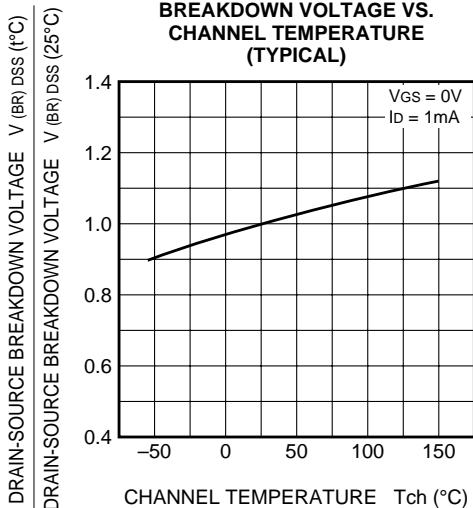

TRANSIENT THERMAL IMPEDANCE CHARACTERISTICS

