

### DESCRIPTION

The SC6433 is a Black and White TV (BWTV) Camera sync pulse generator that produces the necessary output for synchronizing BWTV Camera information. These outputs includes Horizontal Drive, Vertical Drive, Composite Sync, and Composite Blanking, all of which are provided in a format specified by RS 170EIA standard output signals. Also provided are NTSC format and CCIR format which are selectable. The SC6433 is a monolithic integrated circuit manufactured with advanced C-MOS gate technology.

### FEATURES

- RS 170 EIA Standard format
- NTSC format or CCIR format selectable
- GEN-LOCK (phase lock)
- Internal sync, external sync selectable
- Output vertical sync error  $\leq H/5$
- Supply voltage of 5V
- 22 PIN Plastic DIP

### PACKAGE AND DIMENSIONS

[ UNIT : mm ]

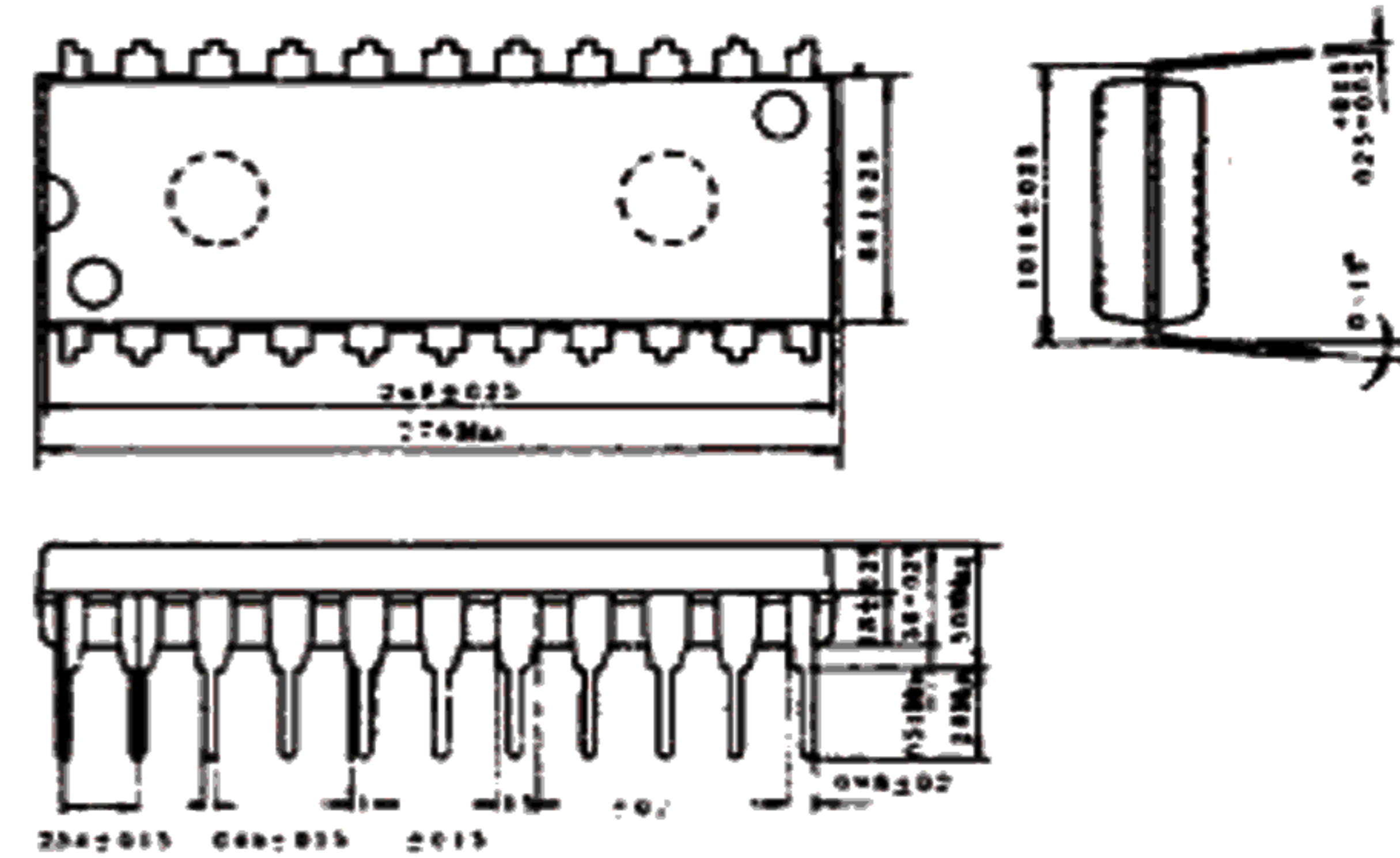

### BLOCK DIAGRAM

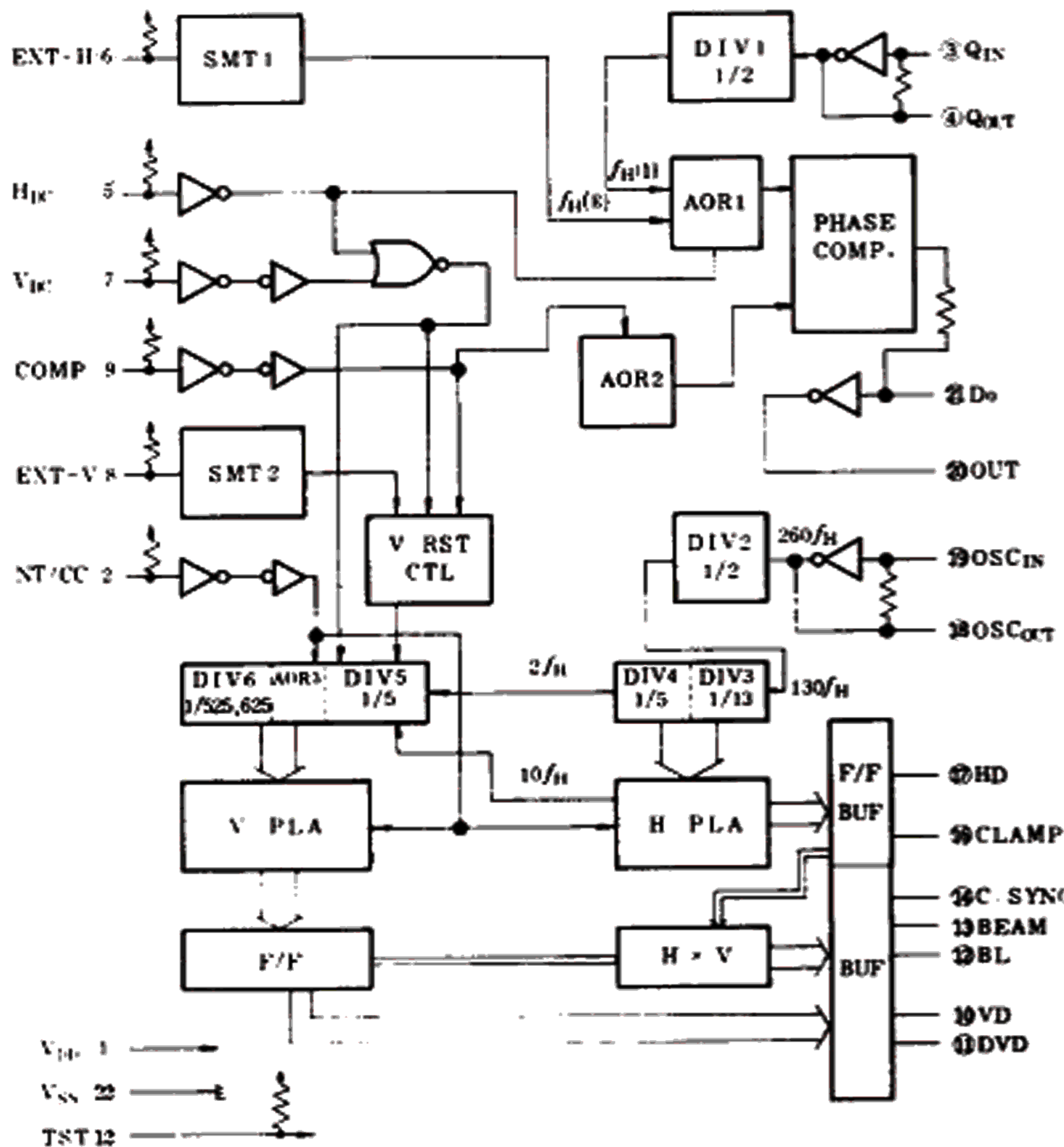

### PIN CONFIGURATION

TOP VIEW

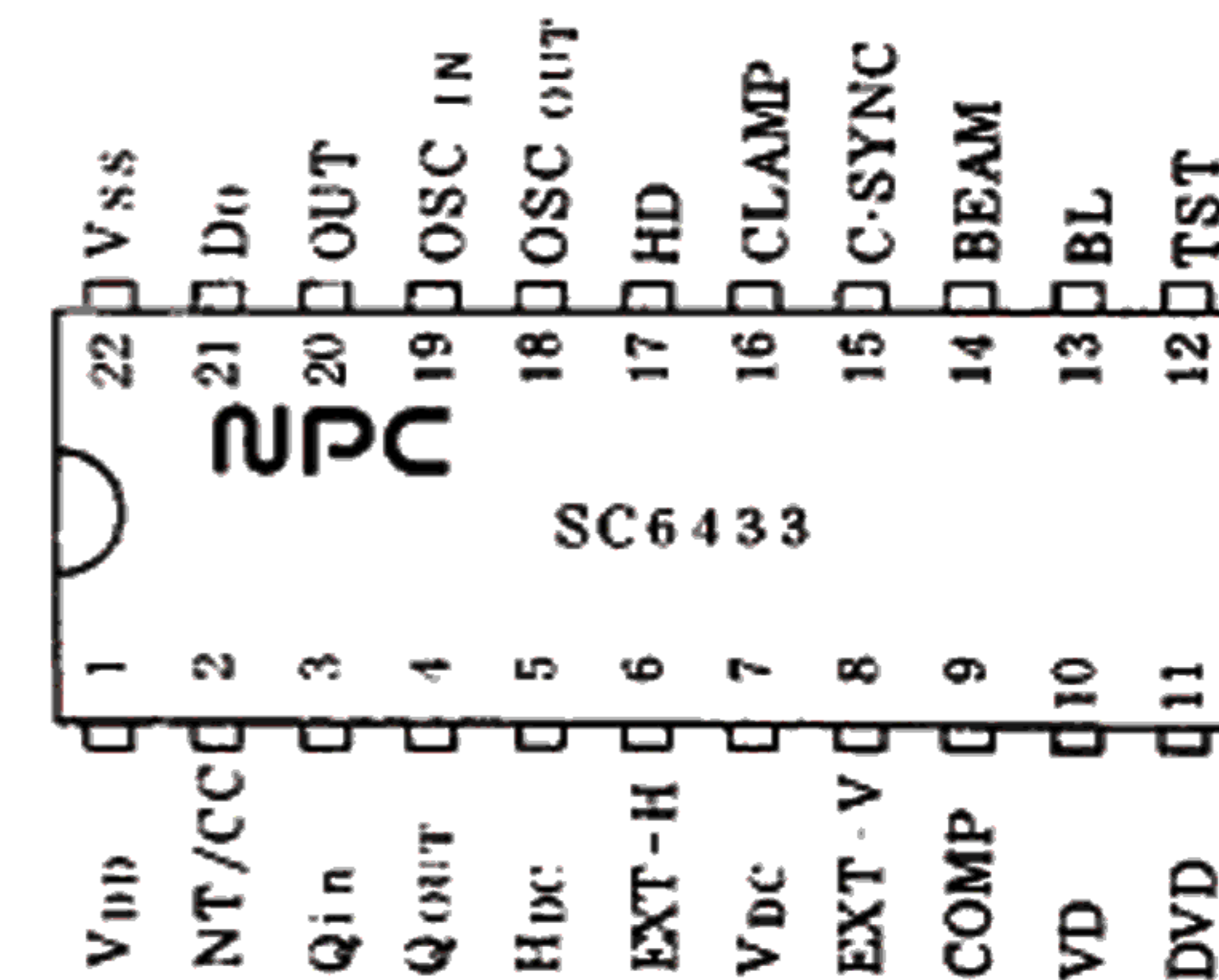

### ABSOLUTE MAXIMUM RATINGS

PARAMETER	SYMBOL	LIMIT	UNIT
VDD	VDD-VSS	-0.3 - 7.0	V
OPERATION TEMP.	T <sub>OP</sub>	-30 - +80	°C
STORAGE TEMP.	T <sub>STO</sub>	-40 - +125	°C
INPUT VOLTAGE	V <sub>IN</sub>	VSS ≤ V <sub>IN</sub> ≤ VDD	V
POWER DISSIPATION	P <sub>w</sub>	200	mW
SOLDERING TEMP.	T <sub>SLD</sub>	260	°C
SOLDERING TEMP.	T <sub>SLD</sub>	5	Sec

## PIN FUNCTION

PIN NO.	SYMBOL	FUNCTION	PIN NO.	SYMBOL	FUNCTION
2	NT/CC	NTCS, CCIR Format Select, "H" = NTSC Format "L" = CCIR Format, Pullup Resistance included	10	VD	Vertical Sync Output
3	QIN	Crystal Oscillator Input	11	DVD	Delayed Vertical Sync Output
4	QOUT	Crystal Oscillator Output	12	TST	Manufacture Testing Pin
5	HDC	Horizontal Sync Clock Select Input, Pullup Resistance included "H" = INT CLOCK "L" = EXT CLOCK (EXT-H)	13	BL	Blanking Output
6	EXT-H	Horizontal Sync Clock Input, Pullup Resistance, Schmidt Circuits Included	14	BEAM	Beam Blanking Output
7	VDC	Vertical INT/EXT Sync Clock Select Input, "H" = INT CLOCK, "L" = EXT CLOCK, Pullup Resistance Included	15	C. SYNC	Composite Sync Output
8	EXT-V	Vertical Ext Sync Clock Input, Schmidt Circuits, Pullup Resistance Included	16	CLAMP	Clamp Pulse Output
9	COMP	Lock Phase Select Input "H" = $\mu p1$ , hp1 "L" = $\mu p2$ , hp2	17	HD	Horizontal Sync Output
			18	OSC out	LC Oscillator Output
			19	OSC in	LC Oscillator Input
			20	OUT	LPF Output
			21	Do	LPF Input / Charge Pump Output
			1	VDD	Supply Voltage +5V
			22	VSS	GND

## APPLICATION

• RECOMMENDED CONDITION

- CRYSTAL PARAMETER
- TUNING FOLK TYPE
- $f_0=31.5$  or  $31.25$  KHz
- $C_1 \leq 35K\Omega$
- $C_0=1.5pF$
- $C_1=2.5mpF$
- Capacitor for Crystal Oscillator
- $C_G=30-50pF$
- $C_D=30-50pF$

• EXTERNAL PARTS

- $R_1=68K\Omega$
- $R_2=1K\Omega$
- $R_3=100K\Omega$
- $R_4=10M\Omega$
- $R_5=220K\Omega$
- $C_1=0.082\mu F$
- $C_2=0.0068\mu F$
- $C_3=51pF$
- $C_4=5-50pF$
- $C_5=5-100pF$
- $C_6=200pF$
- $C_7, C_8...$   
(oscillation adjustment capacitor)
- $L_1=100\mu H$
- $f_{OSC}=4.095$  or  $4.0625$  MHz.

## OPERATING MODE TABLE

MODE INPUT				OPERATION CONDITION						
NT/CC	HDC	VDC	COMP	SYNC CLOCK	MAX FREQUENCY DIVIDER	CRYSTAL OSCILLATION (kHz)	LC OSCILLATOR (MHz)	HD	VD	TIMING DIAGRAM
H	H	H	H	INT	525	31.5	4.095			1, 3
H	H	L	H	EXT	2625	-	-	$f=15.75$ KHz	$f=60$ Hz	4, 5, 6
H	L	H	H	INT	525	-	-	$P_w=0.1H$	$P_w=0.04V$	1
H	L	L	H	EXT	525	-	-			4, 7
H	L	L	L	EXT	525	-	-			4, 8, 9
L	H	H	H	INT	625	31.25	4.0625			2, 3
L	H	L	H	EXT	3125	-	-	$f=15.625$ KHz	$f=50$ Hz	4, 5, 6
L	L	H	H	INT	625	-	-	$P_w=0.1H$	$P_w=0.032V$	1
L	L	L	H	EXT	625	-	-			4, 7,
L	L	L	L	EXT	625	-	-			4, 8, 9

■ **TIMING DIAGRAM** (○ indicate pulse)

• **TIMING DIAGRAM 1** (NT/CC="H", V<sub>DC</sub>="H", FREE RUN MODE)

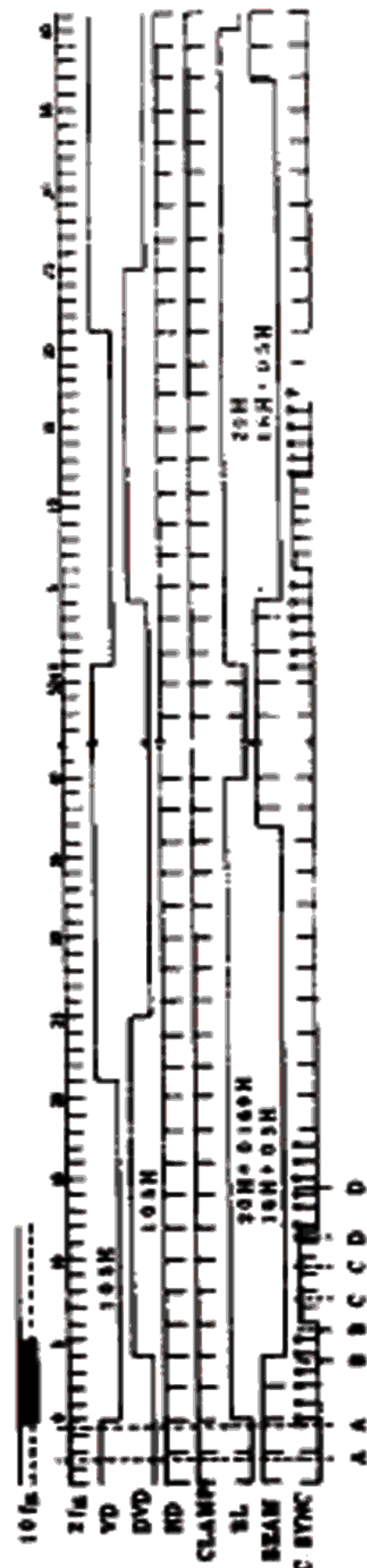

• **TIMING DIAGRAM 2** (NT/CC="L", V<sub>DC</sub>="H", FREE RUN MODE)

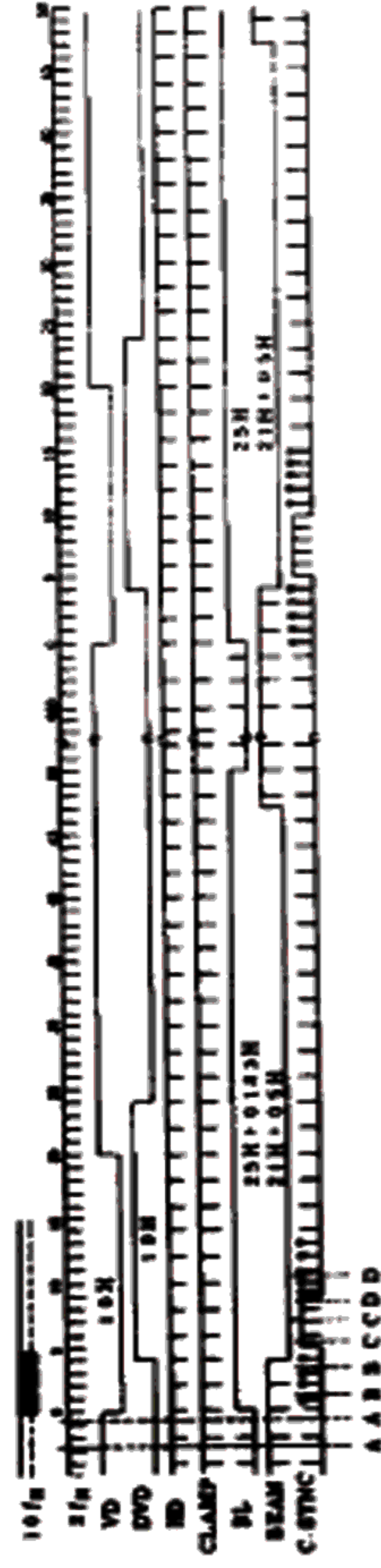

• **TIMING DIAGRAM 3** (NT/CC="H", But \* indicate NT/CC="L")

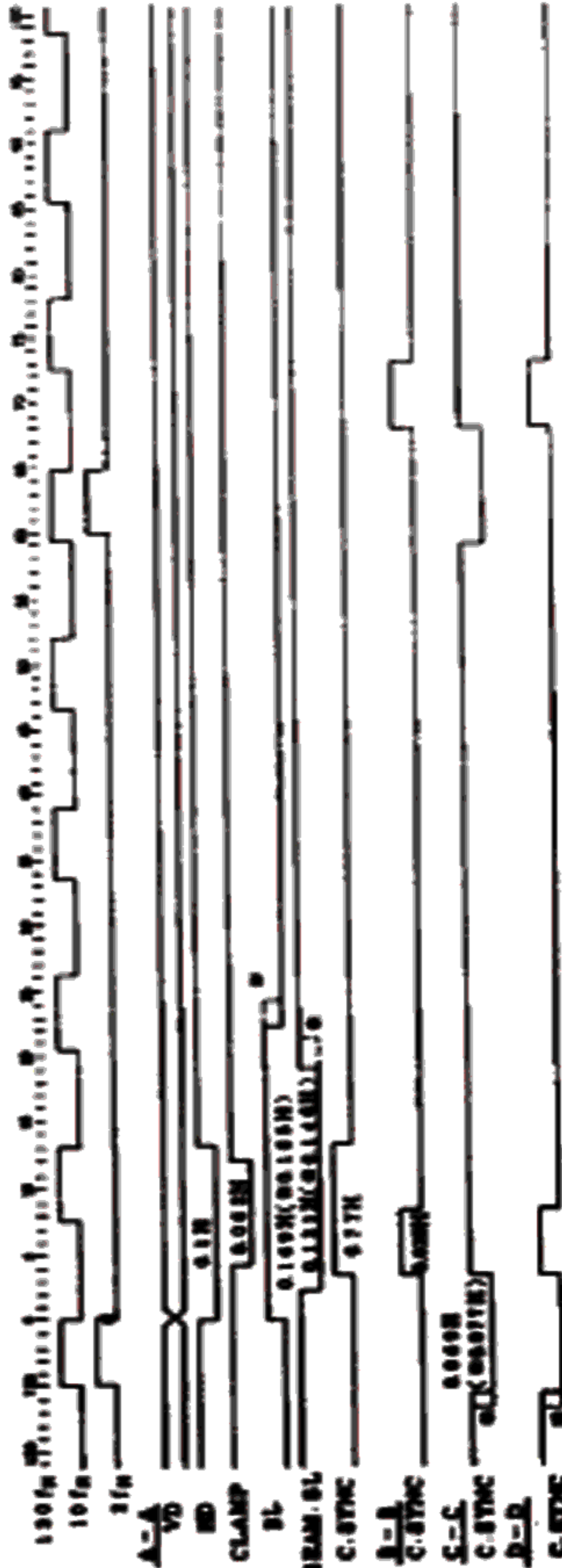

• **TIMING DIAGRAM 4** (EXT-V RESET MODE)



• **TIMING DIAGRAM 5** (EXT-V RESET MODE, V<sub>DC</sub>="L", H<sub>DC</sub>="H")



• **TIMING DIAGRAM 6** (EXT-V RESET MODE, V<sub>DC</sub>="L", H<sub>DC</sub>="H")

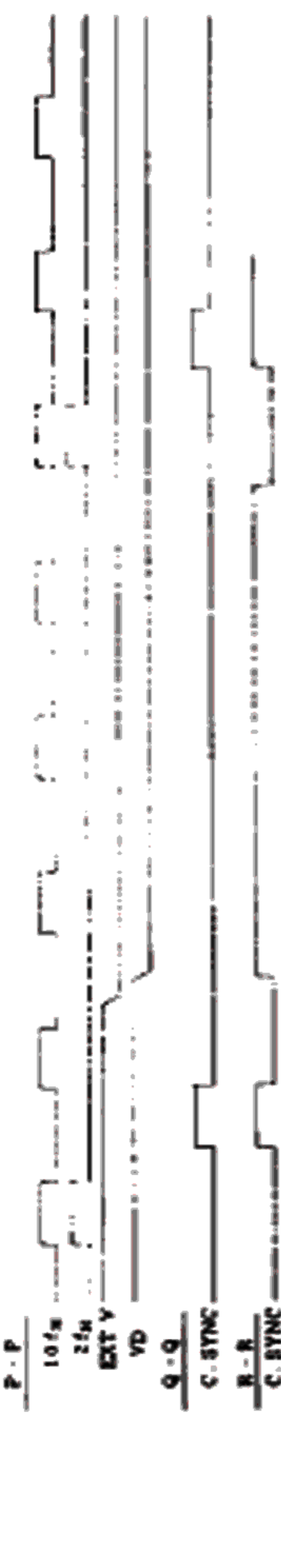

• **TIMING DIAGRAM 7** (EXT-V RESET MODE)

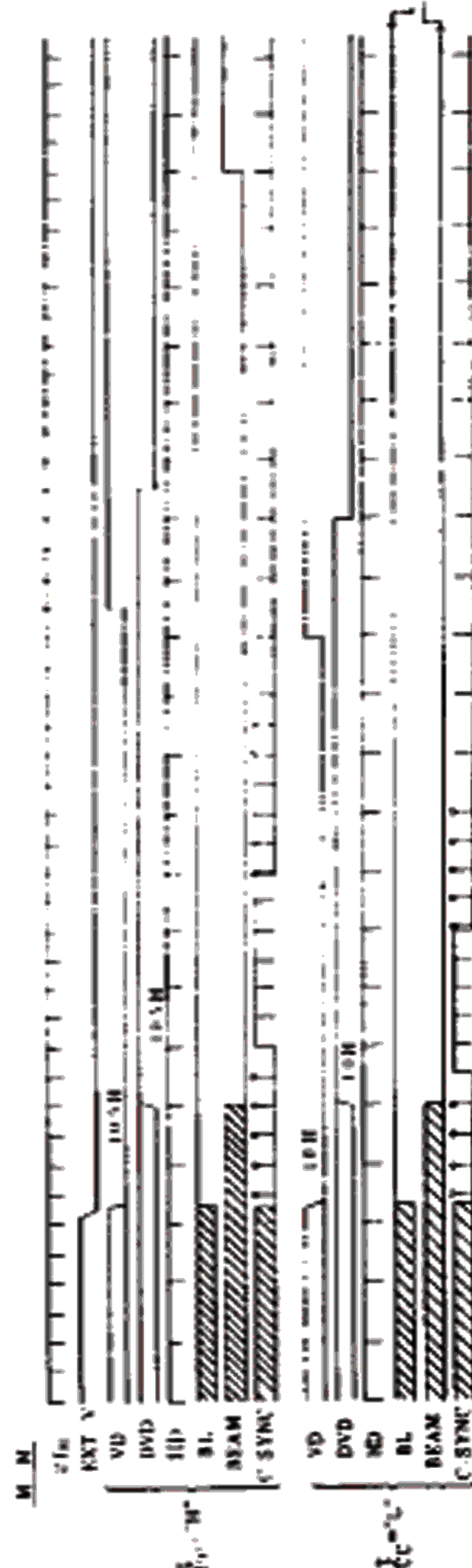

• **TIMING DIAGRAM 8** (EXT-V RESET MODE)

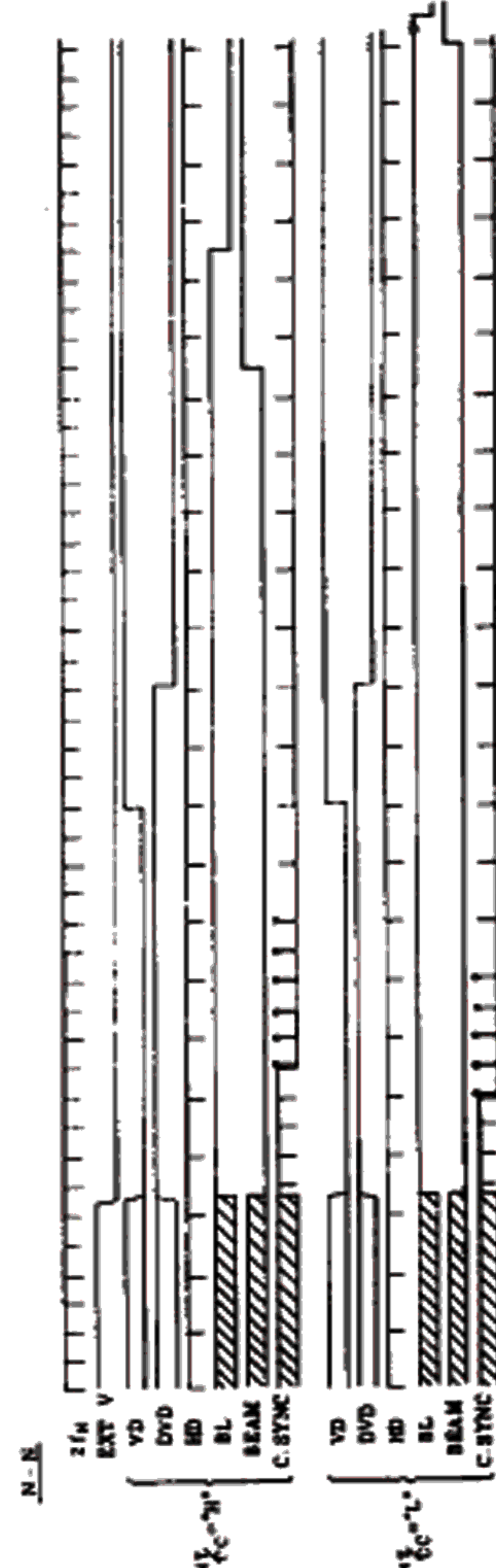

• **TIMING DIAGRAM 9** (EXT-H LOCK MODE, NT/CC="H", H<sub>DC</sub>="L")

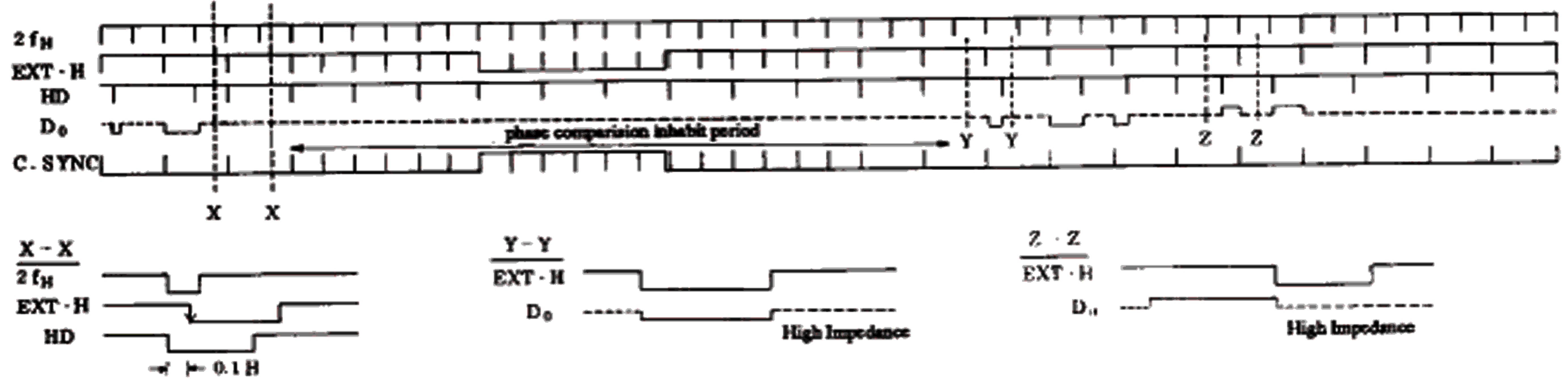

## ELECTRICAL CHARACTERISTICS

(Q<sub>IN</sub>=3.15KHz, OSC<sub>IN</sub>=4.095MHz Self Oscillation, T<sub>a</sub>= -30~80 °C  
V<sub>DD</sub>-V<sub>SS</sub>=4.5~5.5(V), Unless Otherwise Specified)

PARAMETER	PIN	SYMBOL	TEST CONDITION	MIN	TYP	MAX	UNIT
I <sub>DD</sub> CURRENT		I <sub>DD</sub>	NO LOAD			40	mA
INPUT "H" VOLTAGE	EXT-H, EXT-V	V <sub>H</sub>	Except for EXT-H, EXT-V	2.4			V
INPUT "L" VOLTAGE	V <sub>DC</sub> , COMP, NT/CC	V <sub>L</sub>		V <sub>SS</sub>		V <sub>SS</sub> -0.4	V
INPUT PULLUP RESISTOR	H <sub>DC</sub>	R <sub>UP</sub>		50		500	kΩ
MAX FREQ. RESPONSE	OSC IN-OUT	F <sub>MAX1</sub>		5.85			MHz
MAX FREQ. RESPONSE	Q IN-OUT	F <sub>MAX2</sub>		45			kHz
OUTPUT "H" VOLTAGE	HD, CLAMP, BEAM	V <sub>OH1</sub>	V <sub>DD</sub> =4.5V, I <sub>OH</sub> =-500μ	2.4			v
OUTPUT "L" VOLTAGE	C-SYNC, BL, VD, DVD	V <sub>OL1</sub>	V <sub>DD</sub> =4.5V, I <sub>OH</sub> =1mA			0.4	v
OUTPUT CURRENT	D0	I <sub>SAT</sub>	V <sub>O</sub> =V <sub>DD</sub> or V <sub>SS</sub>	200			μA
	OUT	I <sub>OH</sub>	V <sub>O</sub> =V <sub>DD</sub> -0.4V		500		μA
		I <sub>OL</sub>	V <sub>O</sub> =V <sub>SS</sub> +0.4V			500	
INPUT SCHMITT VOLTAGE	EXT-H, EXT-V	V <sub>T+</sub>		V <sub>DD</sub> -0.4V	3		V
		V <sub>T-</sub>			1	V <sub>SS</sub> +0.4V	V
OUTPUT RESPONSE TIME	HD, CLAMP, C-SMIC	t <sub>r</sub> , t <sub>n</sub>	C <sub>L</sub> =15pF			150	nS
FREQUENCY ERROR	BL, VD, DD					±0.2	%
PULSE WIDTH ERROR						±0.5	%
MINIMUM INPUT PULSE WIDTH	EXT-H	t <sub>pw1</sub>		2			μS
	EXT-V	t <sub>pw2</sub>		100			μS
RESPONSE TIME	EXT-H	t <sub>r</sub> , t <sub>n</sub>				150	nS
	EXT-V	t <sub>r</sub> , t <sub>n</sub>				1	μS

Note: Period of Output pulse, pulse width, phase relation is determined by Timing Diagram 1-9

For improvement of products, these specification may change without notice

U.S. Sales Distributor:

## SEPONIX CORPORATION

2151 O'TOOLE AVE., SUITE L, O'TOOLE BUSINESS CENTER  
SAN JOSE, CA 95131

TEL: 408-922-0133 FAX: (408) 922-0137 TLX: 9102405802/  
1-800-237-4590 SEPONIX USA