

# 6MBP100RA120

## IGBT-IPM R series

1200V / 100A 6 in one-package

### Features

- Temperature protection provided by directly detecting the junction temperature of the IGBTs
- Low power loss and soft switching
- High performance and high reliability IGBT with overheating protection
- Higher reliability because of a big decrease in number of parts in built-in control circuit

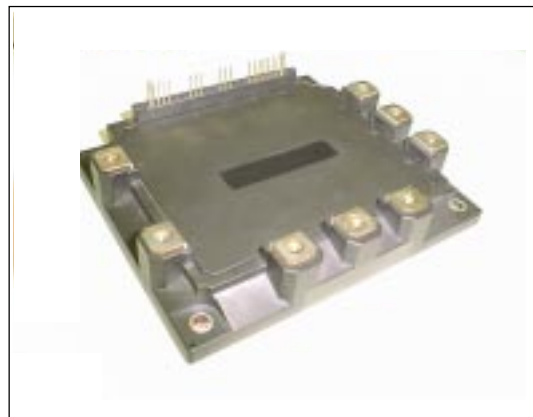

### Maximum ratings and characteristics

- Absolute maximum ratings (at  $T_c=25^\circ\text{C}$  unless otherwise specified)

Item	Symbol	Rating		Unit	
		Min.	Max.		
DC bus voltage	$V_{bc}$	0	900	V	
DC bus voltage (surge)	$V_{bc}(\text{surge})$	0	1000	V	
DC bus voltage (short operating)	$V_{sc}$	200	800	V	
Collector-Emitter voltage	$V_{CES}$	0	1200	V	
INV Collector current	DC	$I_c$	-	100	A
		$I_{cP}$	-	200	A
		$-I_c$	-	100	A
	Collector power dissipation	One transistor	$P_c$	-	735
Junction temperature	$T_j$	-	150	$^\circ\text{C}$	
Input voltage of power supply for Pre-Driver	$V_{cc}^*1$	0	20	V	
Input signal voltage	$V_{in}^*2$	0	$V_z$	V	
Input signal current	$I_{in}$	-	1	mA	
Alarm signal voltage	$V_{ALM}^*3$	0	$V_{cc}$	V	
Alarm signal current	$I_{ALM}^*4$	-	15	mA	
Storage temperature	$T_{stg}$	-40	125	$^\circ\text{C}$	
Operating case temperature	$T_{op}$	-20	100	$^\circ\text{C}$	
Isolating voltage (Case-Terminal)	$V_{iso}^*5$	-	AC2.5	kV	
Screw torque	Mounting (M5)	-	$3.5^*6$	N·m	
	Terminal (M5)	-	$3.5^*6$	N·m	

\*1 Apply  $V_{cc}$  between terminal No. 3 and 1, 6 and 4, 9 and 7, 11 and 10.

\*2 Apply  $V_{in}$  between terminal No. 2 and 1, 5 and 4, 8 and 7, 13,14,15 and 10.

\*3 Apply  $V_{ALM}$  between terminal No. 16 and 10.

\*4 Apply  $I_{ALM}$  to terminal No. 16.

\*5 50Hz/60Hz sine wave 1 minute.

\*6 Recommendable Value : 2.5 to 3.0 N·m

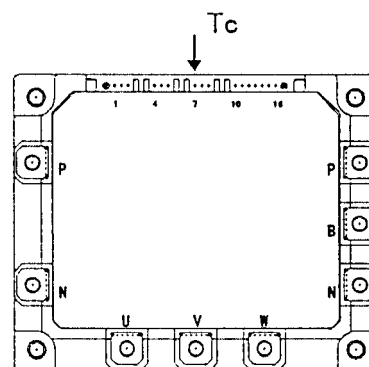

Fig.1 Measurement of case temperature

- Electrical characteristics of power circuit (at  $T_c=T_j=25^\circ\text{C}$ ,  $V_{cc}=15\text{V}$ )

Item	Symbol	Condition	Min.	Typ.	Max.	Unit	
INV	Collector current at off signal input	$I_{CES}$	$V_{CE}=1200\text{V}$ input terminal open	-	-	1.0	mA
	Collector-Emitter saturation voltage	$V_{CE(\text{sat})}$	$I_c=100\text{A}$	-	-	2.6	V
	Forward voltage of FWD	$V_F$	$-I_c=100\text{A}$	-	-	3.0	V

● Electrical characteristics of control circuit(at  $T_c=T_j=25^\circ\text{C}$ ,  $V_{cc}=15\text{V}$ )

Item	Symbol	Condition	Min.	Typ.	Max.	Unit	
Power supply current of P-line side Pre-driver(one unit)	$I_{ccp}$	fsw=0 to 15kHz $T_c=-20$ to $100^\circ\text{C}$ *7	3	-	18	mA	
Power supply current of N-line side three Pre-driver	$I_{ccn}$	fsw=0 to 15kHz $T_c=-20$ to $100^\circ\text{C}$ *7	10	-	65	mA	
Input signal threshold voltage (on/off)	$V_{in(th)}$	ON	1.00	1.35	1.70	V	
		OFF	1.70	2.05	2.40	V	
Input zener voltage	$V_z$	$R_{in}=20\text{k ohm}$	-	8.0	-	V	
Over heating protection temperature level	$T_{COH}$	$V_{DC}=0\text{V}$ , $I_c=0\text{A}$ , Case temperature	110	-	125	$^\circ\text{C}$	
Hysteresis	$T_{CH}$		-	20	-	$^\circ\text{C}$	
IGBT chips over heating protection temperature level	$T_{jOH}$	surface of IGBT chips	150	-	-	$^\circ\text{C}$	
Hysteresis	$T_{jH}$		-	20	-	$^\circ\text{C}$	
Collector current protection level	INV	$I_{oc}$	$T_j=125^\circ\text{C}$	150	-	A	
Over current protection delay time (Fig.2)		$t_{DOC}$	$T_j=25^\circ\text{C}$ Fig.2	-	10	$\mu\text{s}$	
Under voltage protection level		$V_{UV}$		11.0	-	12.5	V
Hysteresis		$V_H$		0.2	-	-	V
Alarm signal hold time		$t_{ALM}$		1.5	2	-	ms
SC protection delay time		$t_{SC}$	$T_j=25^\circ\text{C}$ Fig.3	-	-	12	$\mu\text{s}$
Limiting resistor for alarm		$R_{ALM}$		1425	1500	1575	ohm

\*7 Switching frequency of IGBT

● Dynamic characteristics(at  $T_c=T_j=125^\circ\text{C}$ ,  $V_{cc}=15\text{V}$ )

Item	Symbol	Condition	Min.	Typ.	Max.	Unit
Switching time (IGBT)	$t_{on}$	$I_C=100\text{A}$ , $V_{DC}=600\text{V}$	0.3	-	-	$\mu\text{s}$
	$t_{off}$		-	-	3.6	$\mu\text{s}$
Switching time (FWD)	$t_{rr}$	$I_F=100\text{A}$ , $V_{DC}=600\text{V}$	-	-	0.4	$\mu\text{s}$

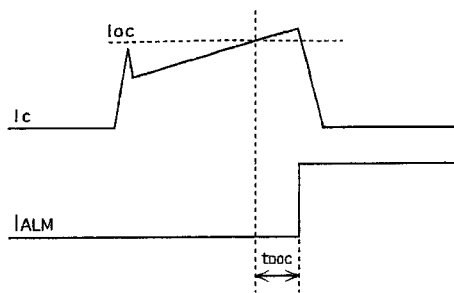

Fig.2 Definition of OC delay time

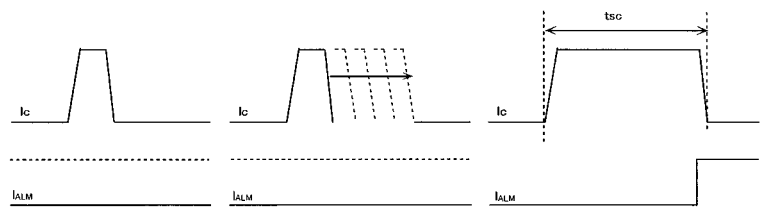

Fig.3 Definition of tsc

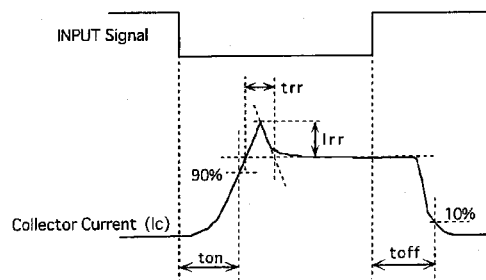

Fig.4 Definition of switching time

● Thermal characteristics( $T_c=25^\circ\text{C}$ )

Item	Symbol	Typ.	Max.	Unit		
Junction to Case thermal resistance	INV	IGBT	$R_{th(j-c)}$	-	0.17	$^\circ\text{C/W}$
		FWD	$R_{th(j-c)}$	-	0.36	$^\circ\text{C/W}$
Case to fin thermal resistance with compound	$R_{th(c-f)}$	0.05	-	-	$^\circ\text{C/W}$	

● Recommendable value

Item	Symbol	Min.	Typ.	Max.	Unit	
DC bus voltage	$V_{DC}$	200	-	800	V	
Operating power supply voltage range of Pre-driver	$V_{cc}$	13.5	15	16.5	V	
Switching frequency of IPM	fsw	1	-	20	kHz	
Screw torque	Mounting (M5)	-	2.5	-	3.0	N·m
	Terminal (M5)	-	2.5	-	3.0	N·m

Block diagram

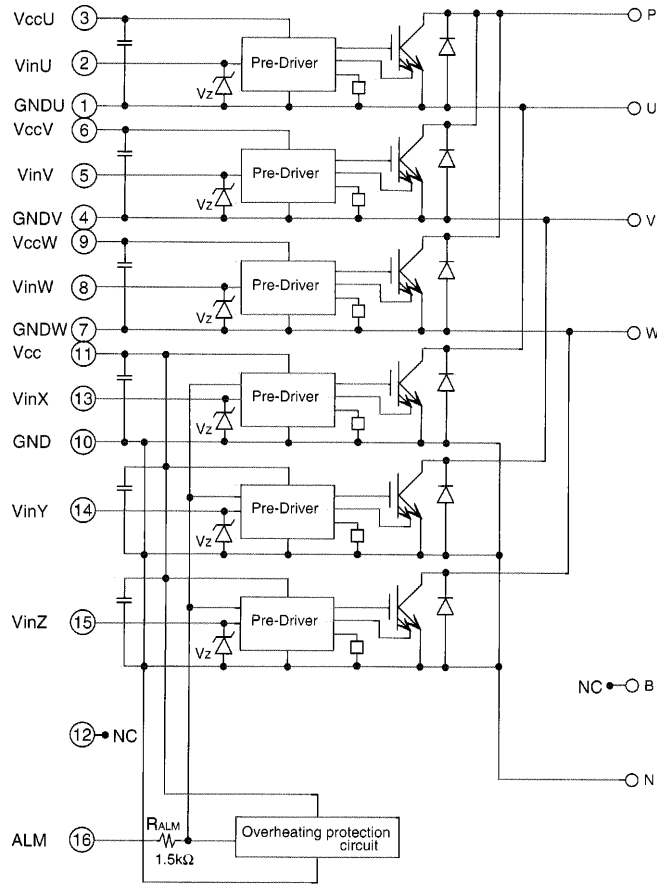

- Pre-drivers include following functions
- a) Amplifier for driver
  - b) Short circuit protection
  - c) Undervoltage lockout circuit
  - d) Over current protection
  - e) IGBT chip over heating protection

Outline drawings, mm

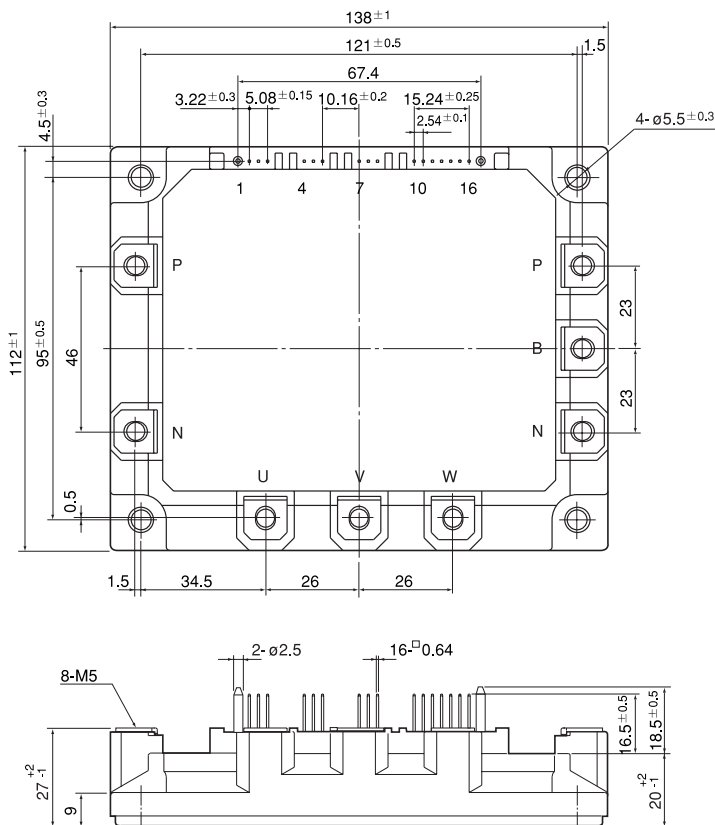

Mass : 920g

Characteristics (Representative)

Control Circuit

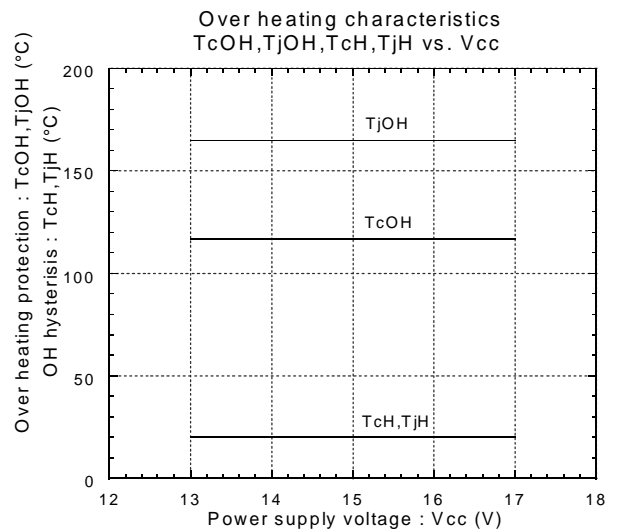
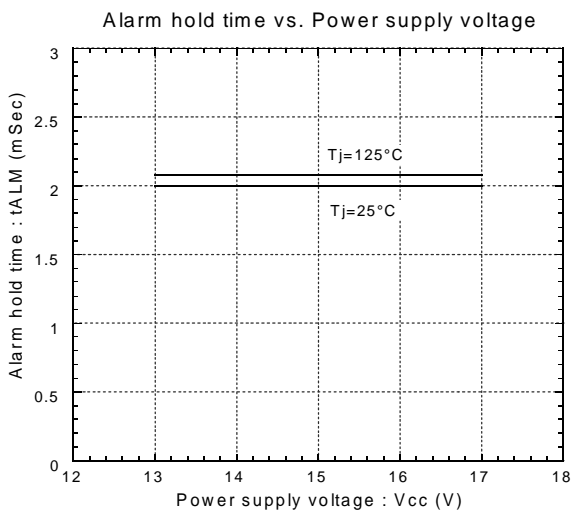
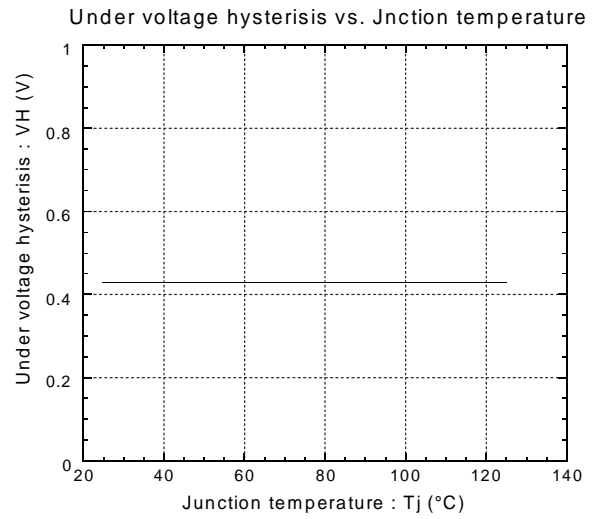
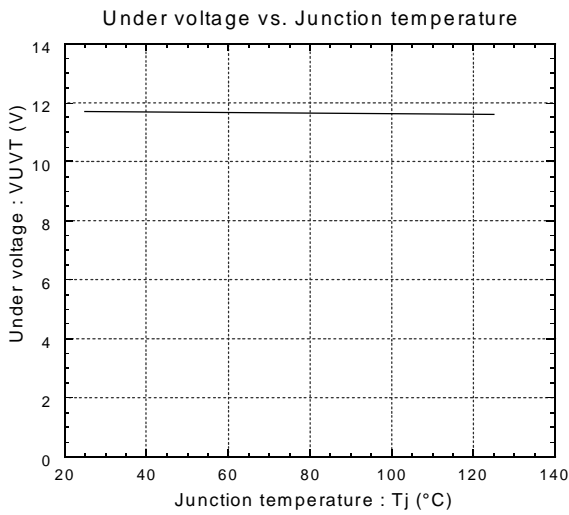
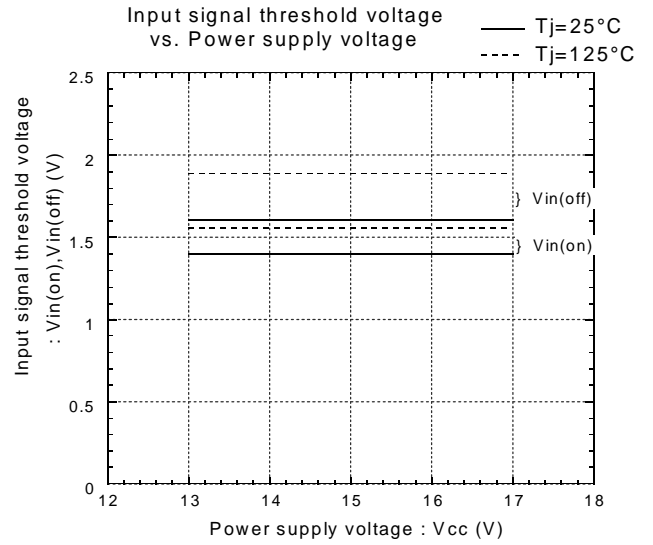
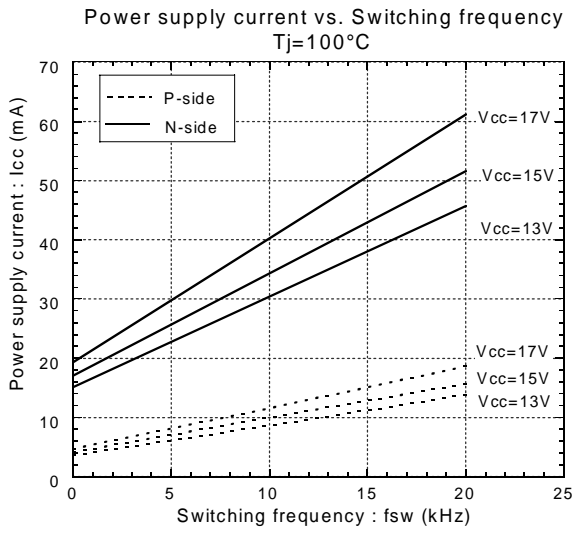

● Inverter

Collector current vs. Collector-Emittor voltage  
T<sub>j</sub>=25°C

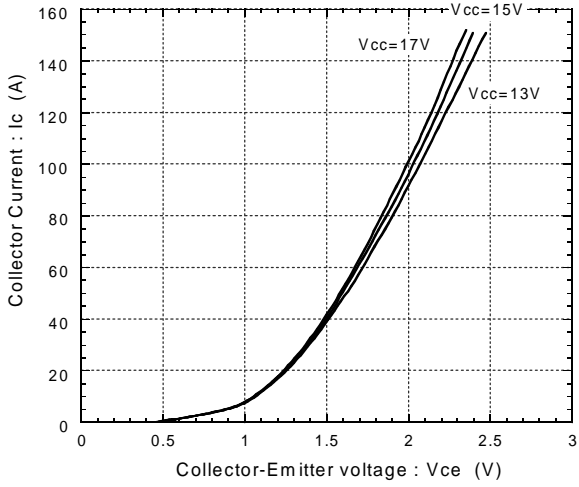

Collector current vs. Collector-Emittor voltage  
T<sub>j</sub>=125°C

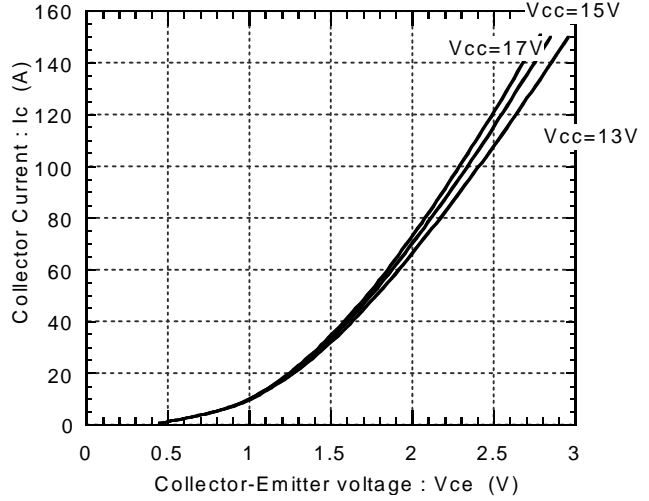

Switching time vs. Collector current  
E<sub>dc</sub>=600V, V<sub>cc</sub>=15V, T<sub>j</sub>=25°C

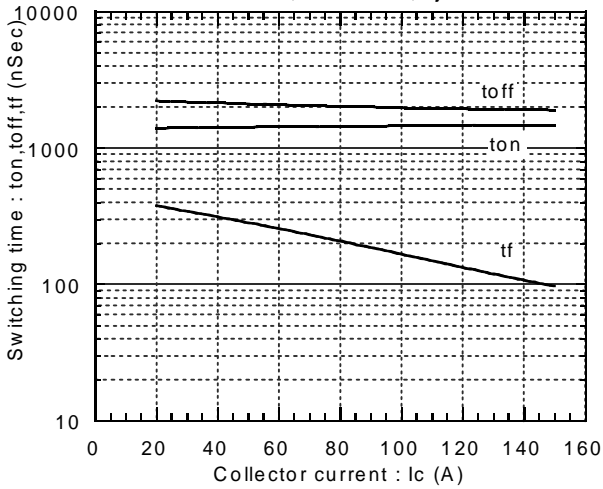

Switching time vs. Collector current  
E<sub>dc</sub>=600V, V<sub>cc</sub>=15V, T<sub>j</sub>=125°C

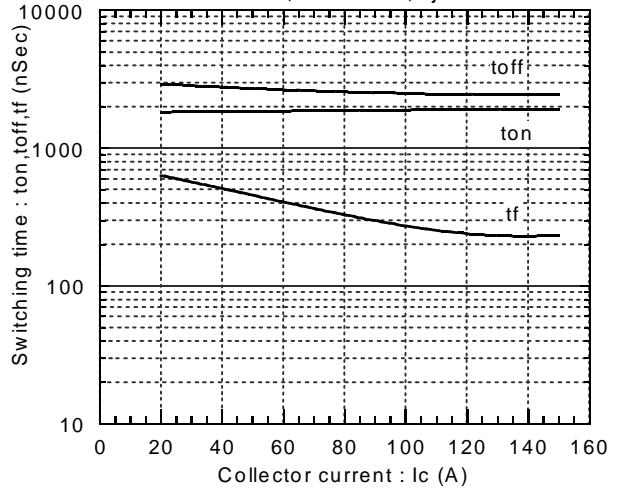

Forward current vs. Forward voltage

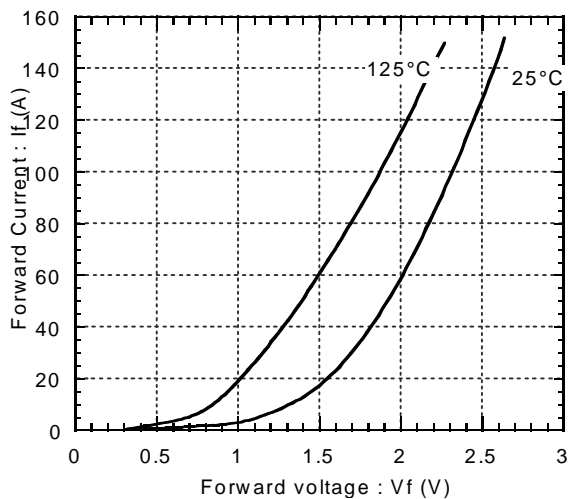

Reverse recovery characteristics  
trr, Irr vs. IF

