

## The RF Line Wideband Linear Amplifiers

... designed for amplifier applications in 50 to 100 ohm systems requiring wide bandwidth, low noise and low distortion. This hybrid provides excellent gain stability with temperature and linear amplification as a result of the push-pull circuit design.

- Specified Characteristics at  $V_{CC} = 28\text{ V}$ ,  $T_C = 25^\circ\text{C}$ :
  - Frequency Range — 10 to 1000 MHz
  - Output Power — 1 W Typ @ 1 dB Compression,  $f = 900\text{ MHz}$
  - Power Gain — 15.5 Typ @  $f = 1000\text{ MHz}$
  - Noise Figure — 7.5 dB Typ @  $f = 500\text{ MHz}$
  - ITO — 40.5 dBm @  $f = 1000\text{ MHz}$
- All Gold Metallization for Improved Reliability
- Optimized for 28 V Operation

**CA5800C**  
**CA5800CS**

15 dB  
10–1000 MHz  
1 WATT  
WIDEBAND  
LINEAR AMPLIFIERS

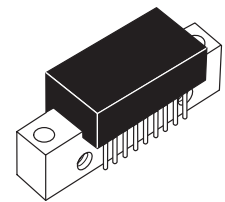

CASE 714P-03, STYLE 2  
(CA)  
CA5800C

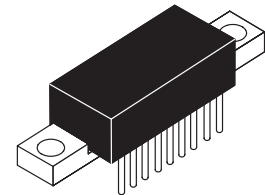

CASE 714T-03, STYLE 1  
CA5800CS

### MAXIMUM RATINGS

Rating	Symbol	Value	Unit
DC Supply Voltage	$V_{CC}$	32	Vdc
RF Power Input	$P_{in}$	+18	dBm
Operating Case Temperature Range	$T_C$	-20 to +100	$^\circ\text{C}$
Storage Temperature Range	$T_{stg}$	-40 to +100	$^\circ\text{C}$

### ELECTRICAL CHARACTERISTICS ( $T_C = 25^\circ\text{C}$ , $V_{CC} = 28\text{ V}$ , 50 $\Omega$ system unless otherwise noted)

Characteristic	Symbol	Min	Typ	Max	Unit
Frequency Range (3 dB Down at 10 MHz)	BW	10	—	1000	MHz
Gain Flatness ( $f = 40\text{--}1000\text{ MHz}$ )	—	—	1	2	dB
Power Gain ( $f = 1000\text{ MHz}$ )	$P_G$	14.5	15.5	—	dB
Noise Figure, Broadband $f = 500\text{ MHz}$ $f = 1000\text{ MHz}$	NF	—	7.5 8.5	8.5 9.5	dB
Power Output — 1 dB Compression ( $f = 900\text{ MHz}$ )	$P_{o\ 1dB}$	800	1000	—	mW
Third Order Intercept (See Figure 1, $f_1 = 10\text{--}1000\text{ MHz}$ )	ITO	—	40.5	—	dBm
Input/Output VSWR $f = 40\text{--}900\text{ MHz}$ $f = 900\text{--}1000\text{ MHz}$	VSWR	—	—	2:1 2.6:1	—
Second Harmonic Distortion ( $P_o = 100\text{ mW}$ , $f_{2H} = 1000\text{ MHz}$ )	$d_{so}$	—	-55	-45	dB
Supply Current	$I_{CC}$	360	400	440	mA
Intermodulation Distortion, 3 Tone (Vision Carrier = -8 dB, Sound Carrier = -10 dB, Sideband Signal = -17 dB. See Figure 2. $f = 860\text{ MHz}$ , $P_{sync} = 200\text{ mW}$ )	IMD	—	-58	—	dB
Second Order IMD ( $P_1 = 2.75\text{ dBm}$ , $f_1 = 373\text{ MHz}$ , $f_2 = 450\text{ MHz}$ , See Figure 1)	IM2	—	-65	-60	dB

ARCHIVE INFORMATION

ARCHIVE INFORMATION



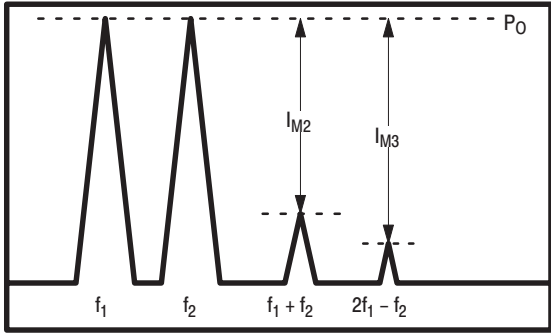

$$ITO = P_0 + \frac{IM3}{2} @ IM3 > 60 \text{ dB}$$

Figure 1. 2-Tone Intermodulation, Test B

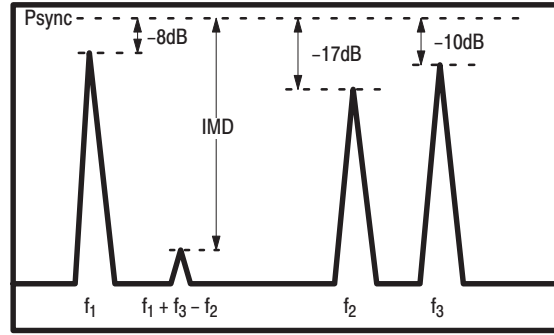

f1: video  
f2: sideband  
f3: sound

Figure 2. 3-Tone TV Intermodulation Test

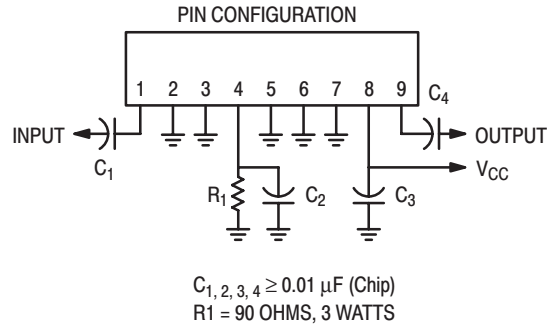

CA5800C (Case 714P-03, Style 2)  
CA5800CS (Case 714T-03, Style 1)

Figure 3. External Connections

# PACKAGE DIMENSIONS

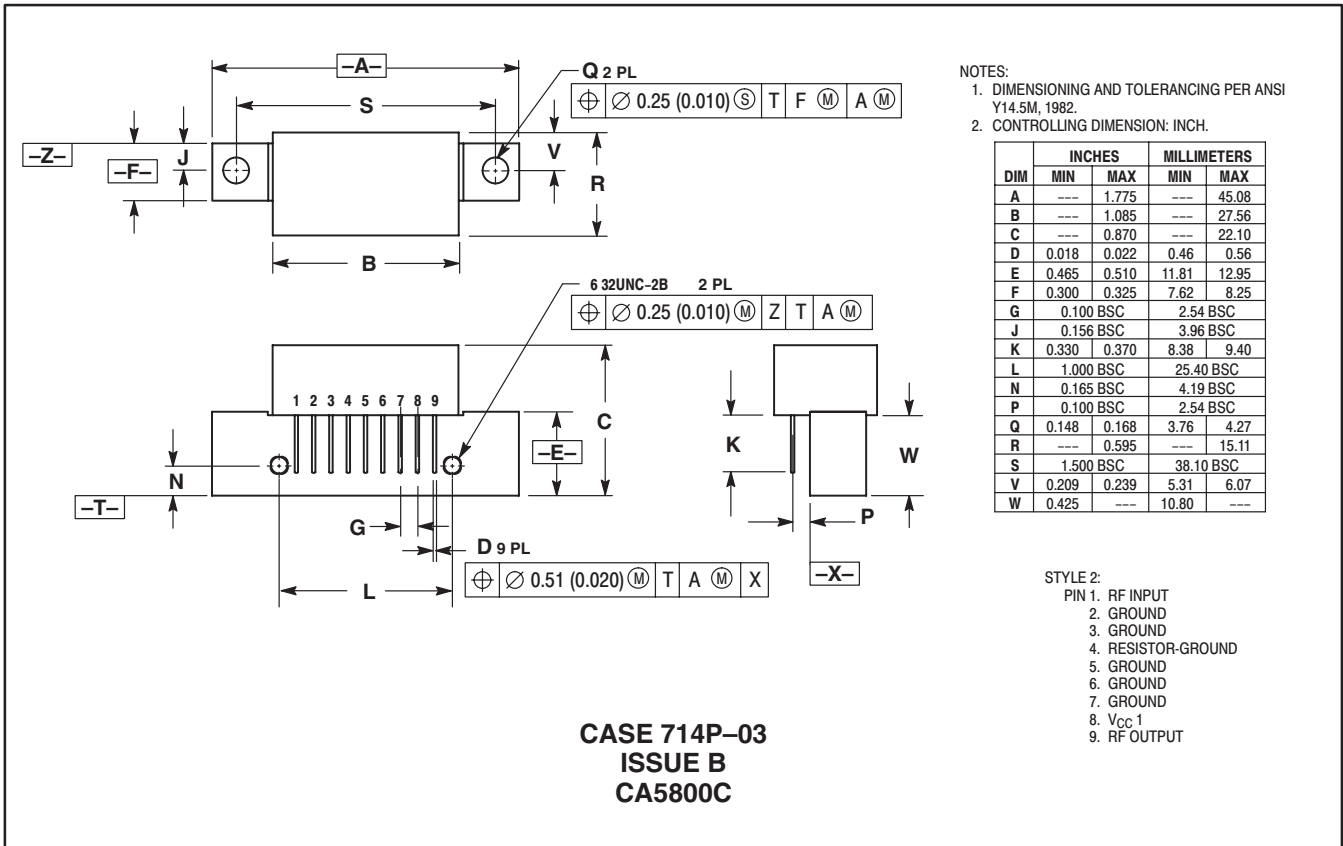

- NOTES:  
 1. DIMENSIONING AND TOLERANCING PER ANSI Y14.5M, 1982.  
 2. CONTROLLING DIMENSION: INCH.

DIM	INCHES		MILLIMETERS	
	MIN	MAX	MIN	MAX
A	---	1.775	---	45.08
B	---	1.085	---	27.56
C	---	0.870	---	22.10
D	0.018	0.022	0.46	0.56
E	0.465	0.510	11.81	12.95
F	0.300	0.325	7.62	8.25
G	0.100	BSC	2.54	BSC
J	0.156	BSC	3.96	BSC
K	0.330	0.370	8.38	9.40
L	1.000	BSC	25.40	BSC
N	0.165	BSC	4.19	BSC
P	0.100	BSC	2.54	BSC
Q	0.148	0.168	3.76	4.27
R	---	0.595	---	15.11
S	---	1.500	---	38.10 BSC
V	0.209	0.239	5.31	6.07
W	0.425	---	10.80	---

- STYLE 2:  
 PIN 1. RF INPUT  
 2. GROUND  
 3. GROUND  
 4. RESISTOR-GROUND  
 5. GROUND  
 6. GROUND  
 7. GROUND  
 8. V<sub>CC</sub> 1  
 9. RF OUTPUT

ARCHIVE INFORMATION

ARCHIVE INFORMATION

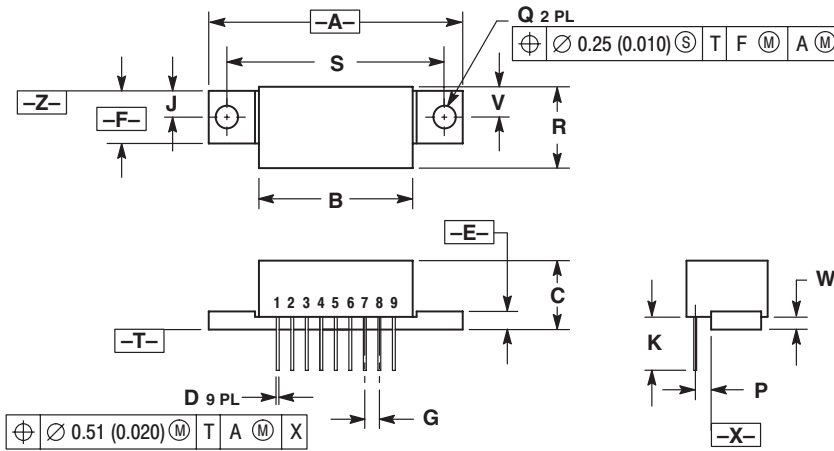

NOTES:  
 1. DIMENSIONING AND TOLERANCING PER ANSI Y14.5M, 1982.  
 2. CONTROLLING DIMENSION: INCH.

DIM	INCHES		MILLIMETERS	
	MIN	MAX	MIN	MAX
A	---	1.775	---	45.08
B	---	1.085	---	27.56
C	---	0.495	---	12.57
D	0.018	0.022	0.46	0.56
E	0.120	0.130	3.05	3.30
F	0.300	0.325	7.62	8.25
G	0.100 BSC		2.54 BSC	
J	0.156 BSC		3.96 BSC	
K	0.330	0.370	8.38	9.40
P	0.100 BSC		2.54 BSC	
Q	0.148	0.168	3.76	4.27
R	---	0.595	---	15.11
S	1.500 BSC		38.10 BSC	
V	0.209	0.239	5.31	6.07
W	0.050	---	1.27	---

- STYLE 1:  
 PIN 1. RF INPUT  
 2. GROUND  
 3. GROUND  
 4. RESISTOR-GROUND  
 5. GROUND  
 6. GROUND  
 7. GROUND  
 8. V<sub>CC</sub> 1  
 9. RF OUTPUT

**CASE 714T-03  
 ISSUE B  
 CA5800CS**

Motorola reserves the right to make changes without further notice to any products herein. Motorola makes no warranty, representation or guarantee regarding the suitability of its products for any particular purpose, nor does Motorola assume any liability arising out of the application or use of any product or circuit, and specifically disclaims any and all liability, including without limitation consequential or incidental damages. "Typical" parameters can and do vary in different applications. All operating parameters, including "Typicals" must be validated for each customer application by customer's technical experts. Motorola does not convey any license under its patent rights nor the rights of others. Motorola products are not designed, intended, or authorized for use as components in systems intended for surgical implant into the body, or other applications intended to support or sustain life, or for any other application in which the failure of the Motorola product could create a situation where personal injury or death may occur. Should Buyer purchase or use Motorola products for any such unintended or unauthorized application, Buyer shall indemnify and hold Motorola and its officers, employees, subsidiaries, affiliates, and distributors harmless against all claims, costs, damages, and expenses, and reasonable attorney fees arising out of, directly or indirectly, any claim of personal injury or death associated with such unintended or unauthorized use, even if such claim alleges that Motorola was negligent regarding the design or manufacture of the part. Motorola and are registered trademarks of Motorola, Inc. Motorola, Inc. is an Equal Opportunity/Affirmative Action Employer.

**How to reach us:**

**USA/EUROPE:** Motorola Literature Distribution;  
 P.O. Box 20912; Phoenix, Arizona 85036. 1-800-441-2447

**JAPAN:** Nippon Motorola Ltd.; Tatsumi-SPD-JLDC, Toshikatsu Otsuki,  
 6F Seibu-Butsuryu-Center, 3-14-2 Tatsumi Koto-Ku, Tokyo 135, Japan. 03-3521-8315

**MFAX:** RMFAX0@email.sps.mot.com - TOUCHTONE (602) 244-6609  
**INTERNET:** http://Design-NET.com

**HONG KONG:** Motorola Semiconductors H.K. Ltd.; 8B Tai Ping Industrial Park,  
 51 Ting Kok Road, Tai Po, N.T., Hong Kong. 852-26629298

