

Low-Cost, Micropower, Low-Dropout, High-Output-Current, SOT23 Voltage References

General Description

The MAX6101–MAX6105 are low-cost, low-dropout (LDO), micropower voltage references. These three-terminal references operate with an input voltage range from ($V_{OUT} + 200\text{mV}$) to 12.6V and are available with output voltage options of 1.25V, 2.5V, 3V, 4.096V, and 5V. They feature a proprietary curvature-correction circuit and laser-trimmed thin-film resistors that result in a low temperature coefficient of 75ppm/°C (max) and an initial accuracy of $\pm 0.4\%$ (max). These devices are specified over the extended temperature range (-40°C to $+85^\circ\text{C}$).

These series-mode voltage references draw only 90 μA of supply current and can source 5mA and sink 2mA of load current. Unlike conventional shunt-mode (two-terminal) references that waste supply current and require an external resistor, these devices offer a supply current that is virtually independent of the supply voltage (with only a 4 $\mu\text{A/V}$ variation with supply voltage) and do not require an external resistor. Additionally, these internally compensated devices do not require an external compensation capacitor and are stable with up to 1 μF of load capacitance. Eliminating the external compensation capacitor saves valuable board area in space-critical applications. Their LDO voltage and supply-independent, ultra-low supply current make these devices ideal for battery-operated, high-performance, low-voltage systems.

The MAX6101–MAX6105 are available in tiny 3-pin SOT23 packages.

Applications

Portable Battery-Powered Systems
 Notebook Computers
 PDAs, GPSs, DMMs
 Cellular Phones
 Hard-Disk Drives

Typical Operating Circuit

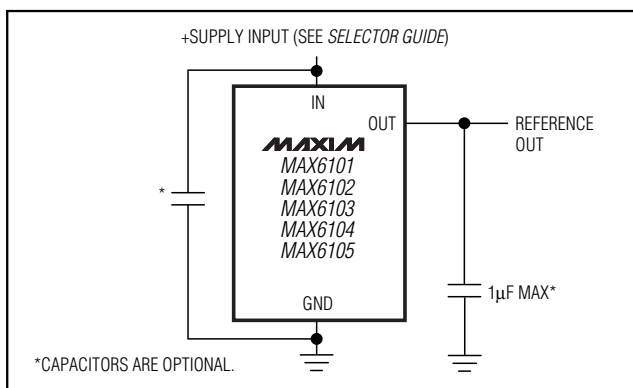

Features

- ◆ Ultra-Small 3-Pin SOT23 Package
- ◆ Low Cost
- ◆ Stable with $C_{LOAD} = 0$ to 1 μF
- ◆ 5mA Source Current
- ◆ $\pm 0.4\%$ max Initial Accuracy
- ◆ Low 75ppm/°C Temperature Coefficient
- ◆ 150 μA max Quiescent Supply Current
- ◆ 50mV Dropout at 1mA Load Current

Ordering Information

PART	TEMP. RANGE	PIN-PACKAGE	TOP MARK
MAX6101EUR-T	-40°C to $+85^\circ\text{C}$	3 SOT23-3	FZGT
MAX6102EUR-T	-40°C to $+85^\circ\text{C}$	3 SOT23-3	FZGU
MAX6103EUR-T	-40°C to $+85^\circ\text{C}$	3 SOT23-3	FZGV
MAX6104EUR-T	-40°C to $+85^\circ\text{C}$	3 SOT23-3	FZGW
MAX6105EUR-T	-40°C to $+85^\circ\text{C}$	3 SOT23-3	FZGX

Note: There is a minimum order increment of 2500 pieces for SOT packages.

Selector Guide

PART	OUTPUT VOLTAGE (V)	INPUT VOLTAGE RANGE (V)
MAX6101	1.250	2.5 to 12.6
MAX6102	2.500	($V_{OUT} + 200\text{mV}$) to 12.6
MAX6103	3.000	($V_{OUT} + 200\text{mV}$) to 12.6
MAX6104	4.096	($V_{OUT} + 200\text{mV}$) to 12.6
MAX6105	5.000	($V_{OUT} + 200\text{mV}$) to 12.6

Pin Configuration

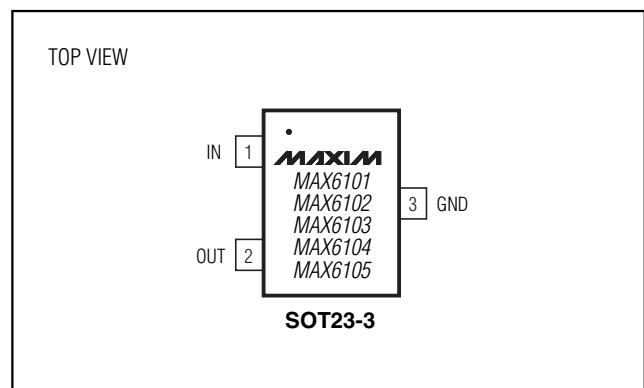

Low-Cost, Micropower, Low-Dropout, High-Output-Current, SOT23 Voltage References

ABSOLUTE MAXIMUM RATINGS

(Voltages Referenced to GND)

IN	-0.3V to +13.5V
OUT	-0.3V to ($V_{IN} + 0.3V$)
Output Short Circuit to GND or IN ($V_{IN} < 6V$)	Continuous
Output Short Circuit to GND or IN ($V_{IN} \geq 6V$)	60s

Continuous Power Dissipation ($T_A = +70^\circ\text{C}$)

3-Pin SOT23 (derate 4.0mW/ $^\circ\text{C}$ above $+70^\circ\text{C}$).....	320mW
Operating Temperature Range	-40°C to $+85^\circ\text{C}$
Storage Temperature Range	-65°C to $+150^\circ\text{C}$
Lead Temperature (soldering, 10s)	$+300^\circ\text{C}$

Stresses beyond those listed under "Absolute Maximum Ratings" may cause permanent damage to the device. These are stress ratings only, and functional operation of the device at these or any other conditions beyond those indicated in the operational sections of the specifications is not implied. Exposure to absolute maximum rating conditions for extended periods may affect device reliability.

ELECTRICAL CHARACTERISTICS—MAX6101, $V_{OUT} = 1.25V$

($V_{IN} = +5V$, $I_{OUT} = 0$, $T_A = T_{MIN}$ to T_{MAX} , unless otherwise noted. Typical values are at $T_A = +25^\circ\text{C}$.) (Note 1)

PARAMETER	SYMBOL	CONDITIONS	MIN	TYP	MAX	UNITS
Output Voltage	V_{OUT}	$T_A = +25^\circ\text{C}$	1.245	1.250	1.255	V
Output Voltage Temperature Coefficient (Notes 2, 3)	TCV_{OUT}	0°C to $+70^\circ\text{C}$			65	ppm/ $^\circ\text{C}$
		-40°C to $+85^\circ\text{C}$			75	
Line Regulation	$\frac{\Delta V_{OUT}}{\Delta V_{IN}}$	$2.5V \leq V_{IN} \leq 12.6V$		7	90	$\mu\text{V/V}$
Load Regulation	$\frac{\Delta V_{OUT}}{\Delta I_{OUT}}$	Sourcing: $0 \leq I_{OUT} \leq 4\text{mA}$		0.7	0.9	mV/mA
		Sinking: $-2\text{mA} \leq I_{OUT} \leq 0$		0.03	3.0	
OUT Short-Circuit Current	I_{SC}	Short to GND		25		mA
		Short to IN		25		
Long-Term Stability	$\frac{\Delta V_{OUT}}{\text{time}}$	1000h at $+25^\circ\text{C}$		50		ppm/1000h
Output Voltage Hysteresis (Note 4)	$\frac{\Delta V_{OUT}}{\text{cycle}}$			130		ppm
DYNAMIC CHARACTERISTICS						
Noise Voltage	e_{OUT}	$f = 0.1\text{Hz}$ to 10Hz		13		$\mu\text{Vp-p}$
		$f = 10\text{Hz}$ to 10kHz		15		μVRMS
Ripple Rejection	$\frac{\Delta V_{OUT}}{\Delta V_{IN}}$	$V_{IN} = 5V \pm 100\text{mV}$, $f = 120\text{Hz}$		86		dB
Turn-On Settling Time	t_R	To $V_{OUT} = 0.1\%$ of final value, $C_{OUT} = 50\text{pF}$		50		μs
Capacitive-Load Stability Range (Note 3)	C_{OUT}		0		1.0	μF
INPUT CHARACTERISTICS						
Supply Voltage Range	V_{IN}	Guaranteed by line-regulation test	2.5		12.6	V
Quiescent Supply Current	I_{IN}			90	150	μA
Change in Supply Current	I_{IN}/V_{IN}	$2.5V \leq V_{IN} \leq 12.6V$		4	10	$\mu\text{A/V}$

Low-Cost, Micropower, Low-Dropout, High-Output-Current, SOT23 Voltage References

MAX6101-MAX6105

ELECTRICAL CHARACTERISTICS—MAX6102, V_{OUT} = 2.50V

(V_{IN} = +5V, I_{OUT} = 0, T_A = T_{MIN} to T_{MAX}, unless otherwise noted. Typical values are at T_A = +25°C.) (Note 1)

PARAMETER	SYMBOL	CONDITIONS	MIN	TYP	MAX	UNITS
Output Voltage	V _{OUT}	T _A = +25°C	2.490	2.50	2.510	V
Output Voltage Temperature Coefficient (Notes 2, 3)	TCV _{OUT}	0°C to +70°C			65	ppm/°C
		-40°C to +85°C			75	
Line Regulation	$\frac{\Delta V_{OUT}}{\Delta V_{IN}}$	(V _{OUT} + 0.2V) ≤ V _{IN} ≤ 12.6V		12	300	μV/V
Load Regulation	$\frac{\Delta V_{OUT}}{\Delta I_{OUT}}$	Sourcing: 0 ≤ I _{OUT} ≤ 5mA		0.6	0.9	mV/mA
		Sinking: -2mA ≤ I _{OUT} ≤ 0		0.025	6.0	
Dropout Voltage (Note 5)	$V_{IN} - V_{OUT}$	I _{OUT} = 1mA		50	200	mV
OUT Short-Circuit Current	I _{SC}	Short to GND		25		mA
		Short to IN		25		
Long-Term Stability	$\frac{\Delta V_{OUT}}{\text{time}}$	1000h at +25°C		50		ppm/ 1000h
Output Voltage Hysteresis (Note 4)	$\frac{\Delta V_{OUT}}{\text{cycle}}$	(Note 2)		130		ppm
DYNAMIC CHARACTERISTICS						
Noise Voltage	e _{OUT}	f = 0.1Hz to 10Hz		27		μVp-p
		f = 10Hz to 10kHz		30		μVRMS
Ripple Rejection	$\frac{\Delta V_{OUT}}{\Delta V_{IN}}$	V _{IN} = 5V ± 100mV, f = 120Hz		86		dB
Turn-On Settling Time	t _R	To V _{OUT} = 0.1% of final value, C _{OUT} = 50pF		115		μs
Capacitive-Load Stability Range (Note 3)	C _{OUT}		0		1.0	μF
INPUT CHARACTERISTICS						
Supply Voltage Range	V _{IN}	Guaranteed by line-regulation test	$V_{OUT} + 0.2$		12.6	V
Quiescent Supply Current	I _{IN}			90	150	μA
Change in Supply Current	I _{IN} /V _{IN}	(V _{OUT} + 0.2V) ≤ V _{IN} ≤ 12.6V		4	10	μA/V

Low-Cost, Micropower, Low-Dropout, High-Output-Current, SOT23 Voltage References

ELECTRICAL CHARACTERISTICS—MAX6103, $V_{OUT} = 3.0V$

($V_{IN} = +5V$, $I_{OUT} = 0$, $T_A = T_{MIN}$ to T_{MAX} , unless otherwise noted. Typical values are at $T_A = +25^\circ C$.) (Note 1)

PARAMETER	SYMBOL	CONDITIONS	MIN	TYP	MAX	UNITS
Output Voltage	V_{OUT}	$T_A = +25^\circ C$	2.988	3.000	3.012	V
Output Voltage Temperature Coefficient (Notes 2, 3)	TCV_{OUT}	$0^\circ C$ to $+70^\circ C$			65	ppm/ $^\circ C$
		$-40^\circ C$ to $+85^\circ C$			75	
Line Regulation	$\frac{\Delta V_{OUT}}{\Delta V_{IN}}$	$(V_{OUT} + 0.2V) \leq V_{IN} \leq 12.6V$		13	400	$\mu V/V$
Load Regulation	$\frac{\Delta V_{OUT}}{\Delta I_{OUT}}$	Sourcing: $0 \leq I_{OUT} \leq 5mA$		0.5	0.9	mV/mA
		Sinking: $-2mA \leq I_{OUT} \leq 0$		0.018	7.0	
Dropout Voltage (Note 5)	$V_{IN} - V_{OUT}$	$I_{OUT} = 1mA$		50	200	mV
OUT Short-Circuit Current	I_{SC}	Short to GND		25		mA
		Short to IN		25		
Long-Term Stability	$\frac{\Delta V_{OUT}}{\text{time}}$	1000h at $+25^\circ C$		50		ppm/1000h
Output Voltage Hysteresis (Note 4)	$\frac{\Delta V_{OUT}}{\text{cycle}}$			130		ppm
DYNAMIC CHARACTERISTICS						
Noise Voltage	e_{OUT}	$f = 0.1Hz$ to $10Hz$		35		$\mu Vp-p$
		$f = 10Hz$ to $10kHz$		40		μV_{RMS}
Ripple Rejection	$\frac{\Delta V_{OUT}}{\Delta V_{IN}}$	$V_{IN} = 5V \pm 100mV$, $f = 120Hz$		76		dB
Turn-On Settling Time	t_R	To $V_{OUT} = 0.1\%$ of final value, $C_{OUT} = 50pF$		115		μs
Capacitive-Load Stability Range (Note 3)	C_{OUT}		0		1.0	μF
INPUT CHARACTERISTICS						
Supply Voltage Range	V_{IN}	Guaranteed by line-regulation test	$V_{OUT} + 0.2$		12.6	V
Quiescent Supply Current	I_{IN}			90	150	μA
Change in Supply Current	I_{IN}/V_{IN}	$(V_{OUT} + 0.2V) \leq V_{IN} \leq 12.6V$		4	10	$\mu A/V$

Low-Cost, Micropower, Low-Dropout, High-Output-Current, SOT23 Voltage References

MAX6101-MAX6105

ELECTRICAL CHARACTERISTICS—MAX6104, V_{OUT} = 4.096V

(V_{IN} = +5V, I_{OUT} = 0, T_A = T_{MIN} to T_{MAX}, unless otherwise noted. Typical values are at T_A = +25°C.) (Note 1)

PARAMETER	SYMBOL	CONDITIONS	MIN	TYP	MAX	UNITS
Output Voltage	V _{OUT}	T _A = +25°C	4.080	4.096	4.112	V
Output Voltage Temperature Coefficient (Notes 2, 3)	TCV _{OUT}	0°C to +70°C			65	ppm/°C
		-40°C to +85°C			75	
Line Regulation	$\frac{\Delta V_{OUT}}{\Delta V_{IN}}$	(V _{OUT} + 0.2V) ≤ V _{IN} ≤ 12.6V		20	430	μV/V
Load Regulation	$\frac{\Delta V_{OUT}}{\Delta I_{OUT}}$	Sourcing: 0 ≤ I _{OUT} ≤ 5mA		0.5	0.9	mV/mA
		Sinking: -2mA ≤ I _{OUT} ≤ 0		0.018	8	
Dropout Voltage (Note 5)	V _{IN} - V _{OUT}	I _{OUT} = 1mA		50	200	mV
OUT Short-Circuit Current	I _{SC}	Short to GND		25		mA
		Short to IN		25		
Long-Term Stability	$\frac{\Delta V_{OUT}}{\text{time}}$	1000h at +25°C		50		ppm/ 1000h
Output Voltage Hysteresis (Note 4)	$\frac{\Delta V_{OUT}}{\text{cycle}}$			130		ppm
DYNAMIC CHARACTERISTICS						
Noise Voltage	e _{OUT}	f = 0.1Hz to 10Hz		50		μVp-p
		f = 10Hz to 10kHz		50		μVRMS
Ripple Rejection	$\frac{\Delta V_{OUT}}{\Delta V_{IN}}$	V _{IN} = 5V ± 100mV, f = 120Hz		72		dB
Turn-On Settling Time	t _R	To V _{OUT} = 0.1% of final value, C _{OUT} = 50pF		190		μs
Capacitive-Load Stability Range (Note 3)	C _{OUT}		0		1.0	μF
INPUT CHARACTERISTICS						
Supply Voltage Range	V _{IN}	Guaranteed by line-regulation test	V _{OUT} + 0.2		12.6	V
Quiescent Supply Current	I _{IN}			90	150	μA
Change in Supply Current	I _{IN} /V _{IN}	(V _{OUT} + 0.2V) ≤ V _{IN} ≤ 12.6V		4	10	μA/V

Low-Cost, Micropower, Low-Dropout, High-Output-Current, SOT23 Voltage References

ELECTRICAL CHARACTERISTICS—MAX6105, $V_{OUT} = 5.000V$

($V_{IN} = +5.2V$, $I_{OUT} = 0$, $T_A = T_{MIN}$ to T_{MAX} , unless otherwise noted. Typical values are at $T_A = +25^\circ C$.) (Note 1)

PARAMETER	SYMBOL	CONDITIONS	MIN	TYP	MAX	UNITS
Output Voltage	V_{OUT}	$T_A = +25^\circ C$	4.980	5.000	5.020	V
Output Voltage Temperature Coefficient (Notes 2, 3)	TCV_{OUT}	$0^\circ C$ to $+70^\circ C$			65	ppm/ $^\circ C$
		$-40^\circ C$ to $+85^\circ C$			75	
Line Regulation	$\frac{\Delta V_{OUT}}{\Delta V_{IN}}$	$(V_{OUT} + 0.2V) \leq V_{IN} \leq 12.6V$		25	550	$\mu V/V$
Load Regulation	$\frac{\Delta V_{OUT}}{\Delta I_{OUT}}$	Sourcing: $0 \leq I_{OUT} \leq 5mA$		0.4	0.9	mV/mA
		Sinking: $-2mA \leq I_{OUT} \leq 0$		0.012	10	
Dropout Voltage (Note 5)	$V_{IN} - V_{OUT}$	$I_{OUT} = 1mA$		50	200	mV
OUT Short-Circuit Current	I_{SC}	Short to GND		25		mA
		Short to IN		25		
Long-Term Stability	$\frac{\Delta V_{OUT}}{\text{time}}$	1000h at $+25^\circ C$		50		ppm/1000h
Output Voltage Hysteresis (Note 4)	$\frac{\Delta V_{OUT}}{\text{cycle}}$			130		ppm
DYNAMIC CHARACTERISTICS						
Noise Voltage	e_{OUT}	$f = 0.1Hz$ to $10Hz$		60		$\mu Vp-p$
		$f = 10Hz$ to $10kHz$		60		$\mu VRMS$
Ripple Rejection	$\frac{\Delta V_{OUT}}{\Delta V_{IN}}$	$V_{IN} = 5V \pm 100mV$, $f = 120Hz$		65		dB
Turn-On Settling Time	t_R	To $V_{OUT} = 0.1\%$ of final value, $C_{OUT} = 50pF$		300		μs
Capacitive-Load Stability Range (Note 3)	C_{OUT}		0		1.0	μF
INPUT CHARACTERISTICS						
Supply Voltage Range	V_{IN}	Guaranteed by line-regulation test	$V_{OUT} + 0.2$		12.6	V
Quiescent Supply Current	I_{IN}			90	150	μA
Change in Supply Current	I_{IN}/V_{IN}	$(V_{OUT} + 0.2V) \leq V_{IN} \leq 12.6V$		4	10	$\mu A/V$

Note 1: Devices are 100% production tested at $T_A = +25^\circ C$ and are guaranteed by design from $T_A = T_{MIN}$ to T_{MAX} by correlation to sample units characterized over temperature.

Note 2: Temperature coefficient is specified by the "box" method; i.e., the maximum ΔV_{OUT} is divided by the maximum Δt .

Note 3: Not production tested. Guaranteed by design.

Note 4: Thermal hysteresis is defined as the change in $+25^\circ C$ output voltage before and after temperature cycling of the device from $T_A = T_{MIN}$ to T_{MAX} .

Note 5: Dropout voltage is the minimum input voltage at which V_{OUT} changes $\leq 0.2\%$ from V_{OUT} at $V_{IN} = 5.0V$ ($V_{IN} = 5.5V$ for MAX6105).

Low-Cost, Micropower, Low-Dropout, High-Output-Current, SOT23 Voltage References

Typical Operating Characteristics

($T_A = +25^\circ\text{C}$, unless otherwise noted.)

MAX6101-MAX6105

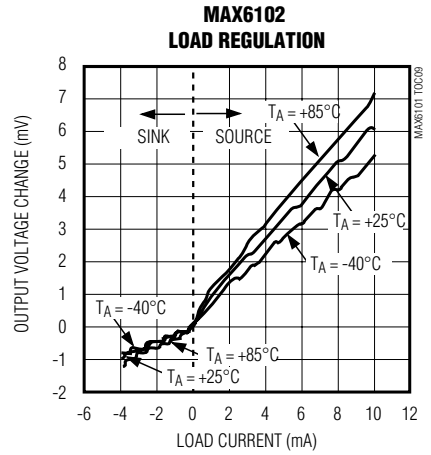
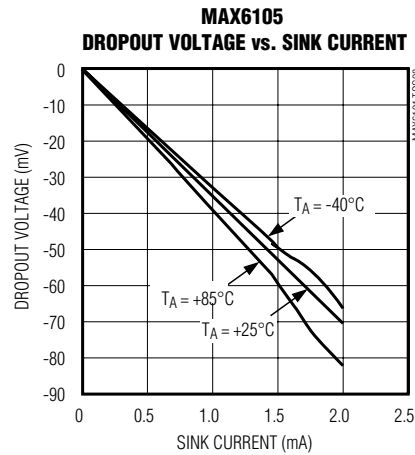
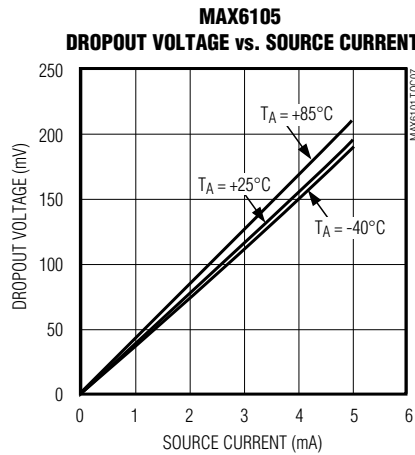
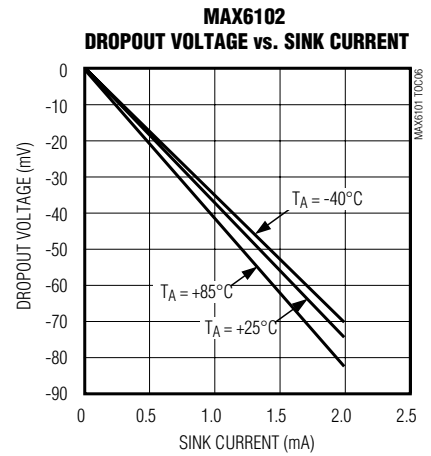
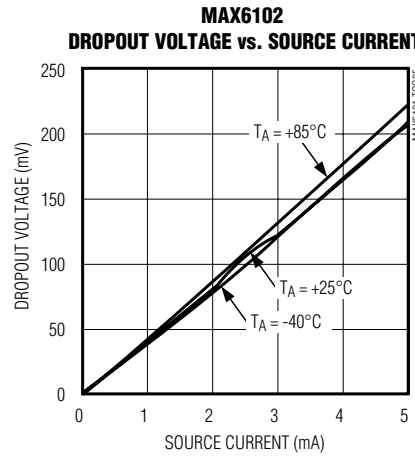
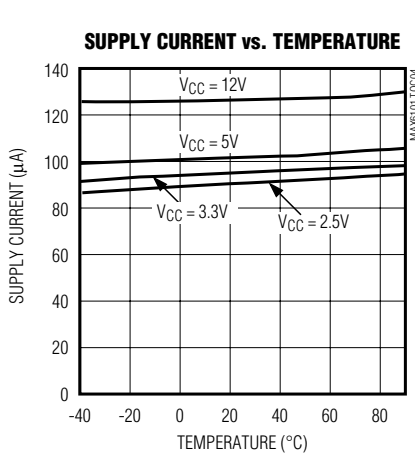
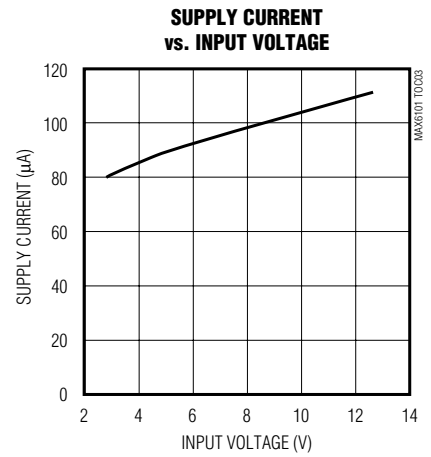
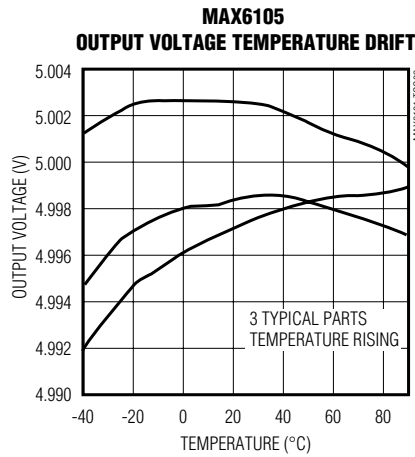
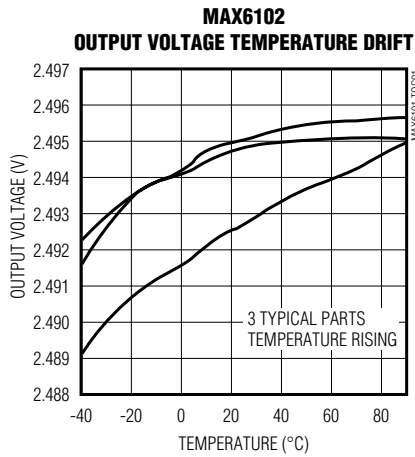

Low-Cost, Micropower, Low-Dropout, High-Output-Current, SOT23 Voltage References

Typical Operating Characteristics (continued)

($T_A = +25^\circ\text{C}$, unless otherwise noted.)

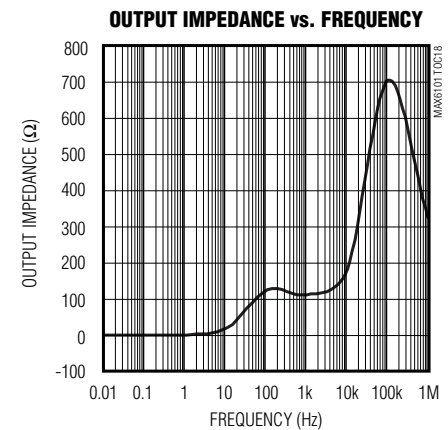
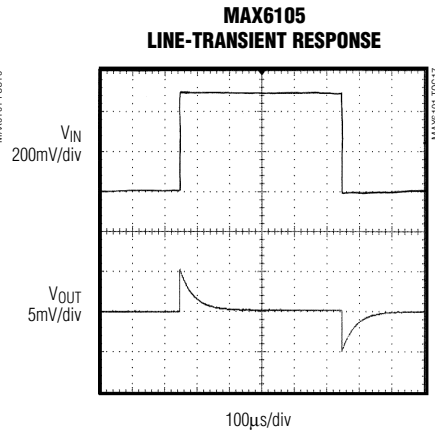
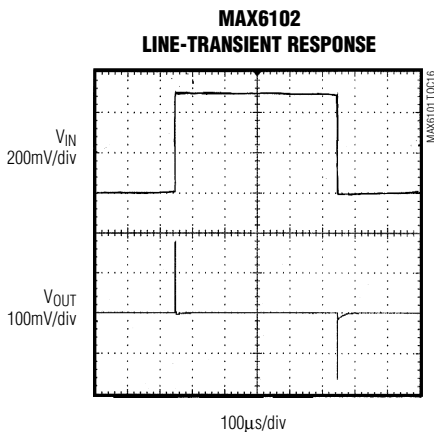
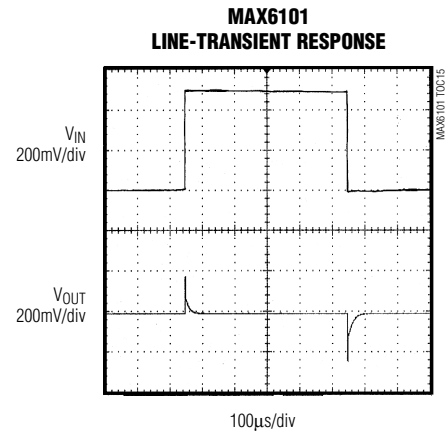
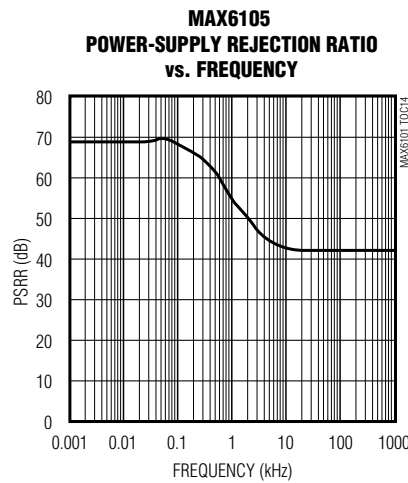
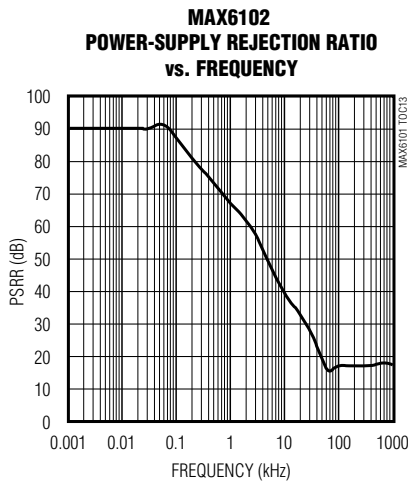
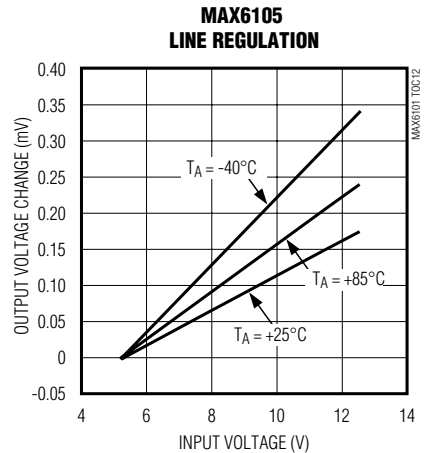
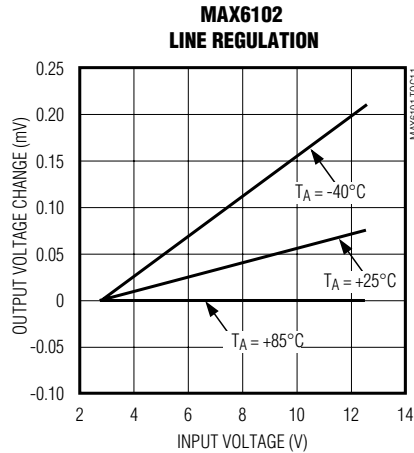
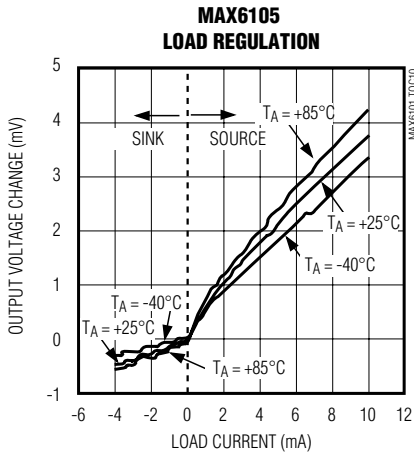

Low-Cost, Micropower, Low-Dropout, High-Output-Current, SOT23 Voltage References

Typical Operating Characteristics (continued)

($T_A = +25^\circ\text{C}$, unless otherwise noted.)

MAX6101-MAX6105

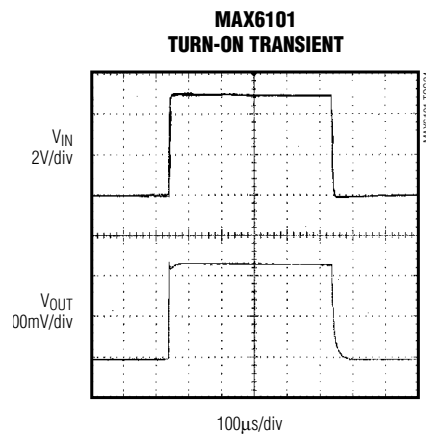
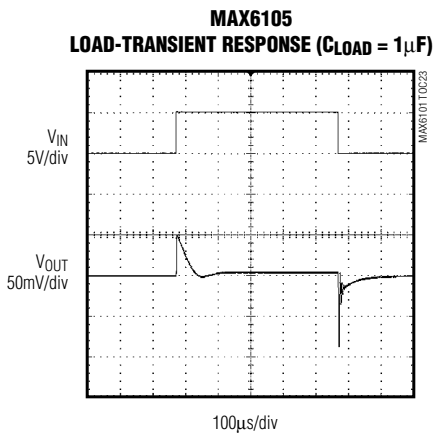
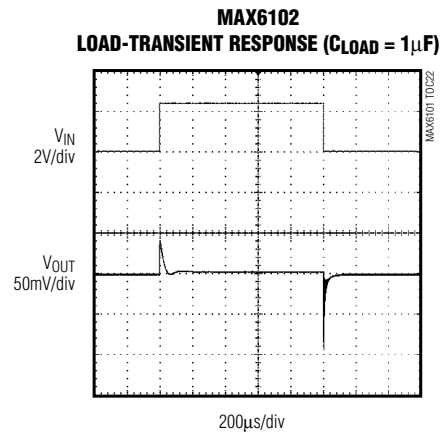
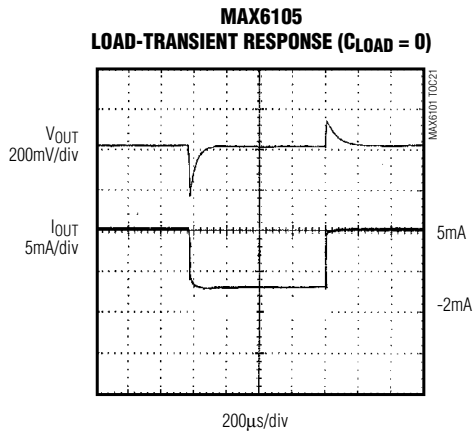
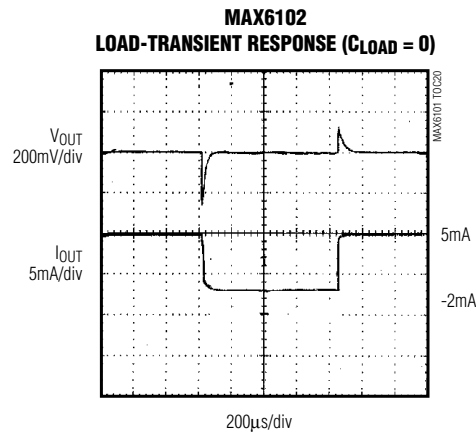
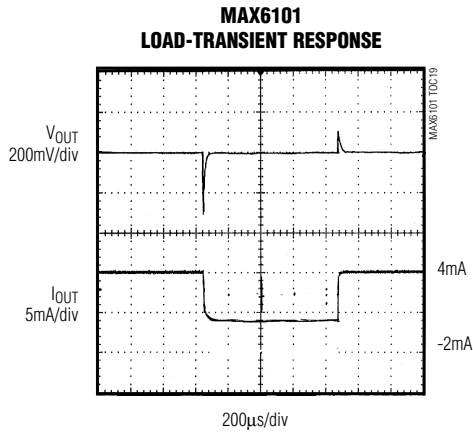

Low-Cost, Micropower, Low-Dropout, High-Output-Current, SOT23 Voltage References

Typical Operating Characteristics (continued)

(T_A = +25°C, unless otherwise noted.)

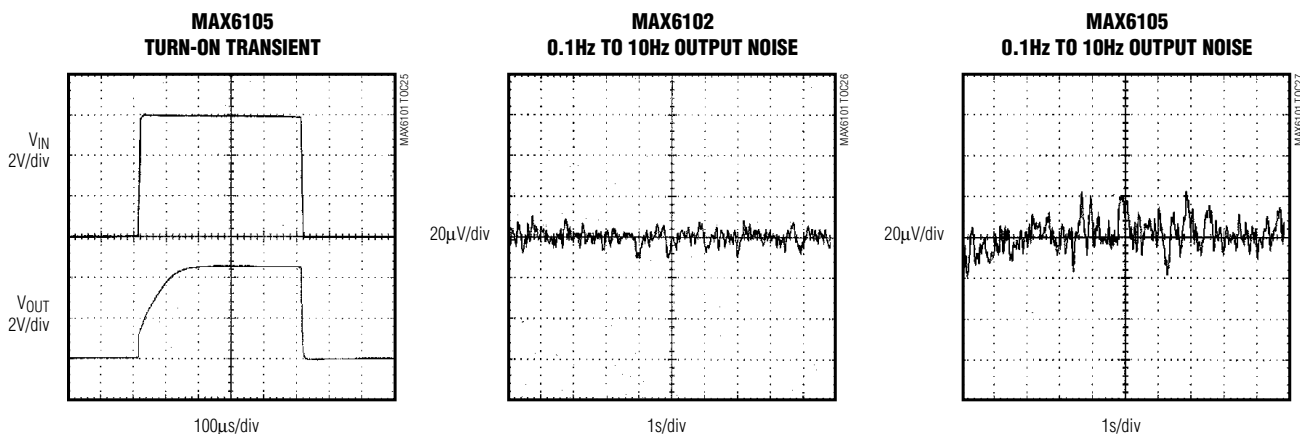

Pin Description

PIN	NAME	FUNCTION
1	IN	Input Voltage
2	OUT	Reference Output
3	GND	Ground

Applications Information

Input Bypassing

For the best line-transient performance, decouple the input with a 0.1µF ceramic capacitor as shown in the *Typical Operating Circuit*. Locate the capacitor as close to IN as possible. Where transient performance is less important, no capacitor is necessary.

Output/Load Capacitance

Devices in the MAX6101 family do not require an output capacitance for frequency stability. They are stable for capacitive loads from 0 to 1µF. However, in applications where the load or the supply can experience step changes, an output capacitor will reduce the amount of overshoot (undershoot) and improve the circuit's transient response. Many applications do not require an external capacitor, and the MAX6101 family can offer a significant advantage in these applications when board space is critical.

Supply Current

The quiescent supply current of the series-mode MAX6101 family is typically 90µA and is virtually independent of the supply voltage, with only a 10µA/V (max) variation with supply voltage. Unlike series references, shunt-mode references operate with a series resistor connected to the power supply. The quiescent current of a shunt-mode reference is thus a function of the input voltage. Additionally, shunt-mode references have to be biased at the maximum expected load current, even if the load current is not present at the time. In the MAX6101 family, the load current is drawn from the input voltage only when required, so supply current is not wasted and efficiency is maximized at all input voltages. This improved efficiency reduces power dissipation and extends battery life. When the supply voltage is below the minimum specified input voltage (as during turn-on), the devices can draw up to 400µA beyond the nominal supply current. The input voltage source must be capable of providing this current to ensure reliable turn-on.

Output Voltage Hysteresis

Output voltage hysteresis is the change of output voltage at T_A = +25°C before and after the device is cycled over its entire operating temperature range. Hysteresis is caused by differential package stress appearing across the bandgap core transistors. The typical temperature hysteresis value is 130ppm.

Low-Cost, Micropower, Low-Dropout, High-Output-Current, SOT23 Voltage References

MAX6101-MAX6105

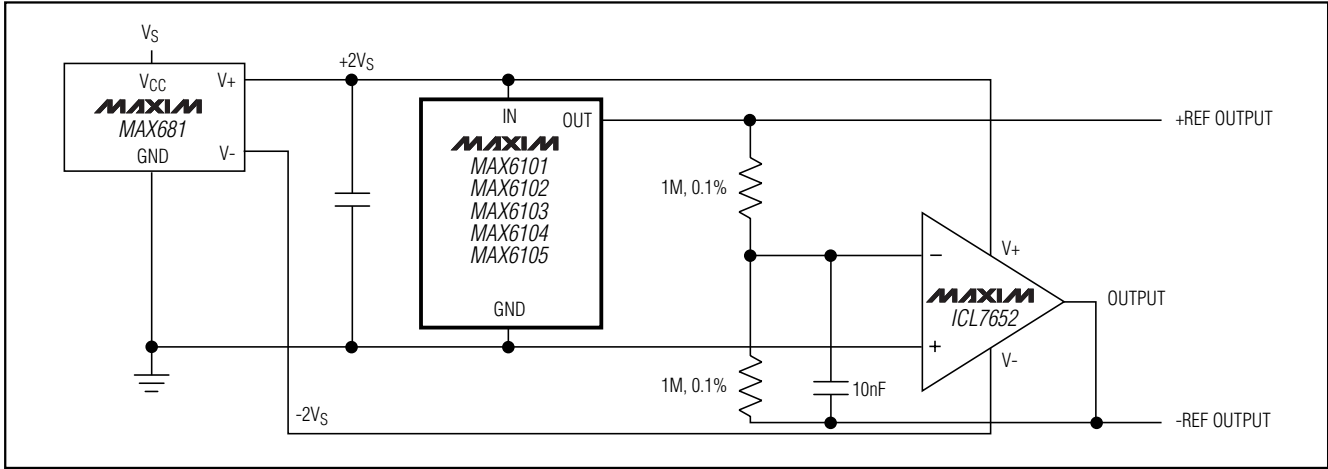

Figure 1. Positive and Negative References from Single +3V or +5V Supply

Turn-On Time

These devices typically turn on and settle to within 0.1% of their final value in $50\mu\text{s}$ to $300\mu\text{s}$. The turn-on time can increase up to 1.5ms with the device operating at the minimum dropout voltage and the maximum load.

Positive and Negative Low-Power Voltage Reference

Figure 1 shows a typical method for developing a bipolar reference. The circuit uses a MAX681 voltage doubler/inverter charge-pump converter to power an ICL7652, thus creating a positive as well as a negative reference voltage.

Chip Information

TRANSISTOR COUNT: 117

Low-Cost, Micropower, Low-Dropout, High-Output-Current, SOT23 Voltage References

Package Information

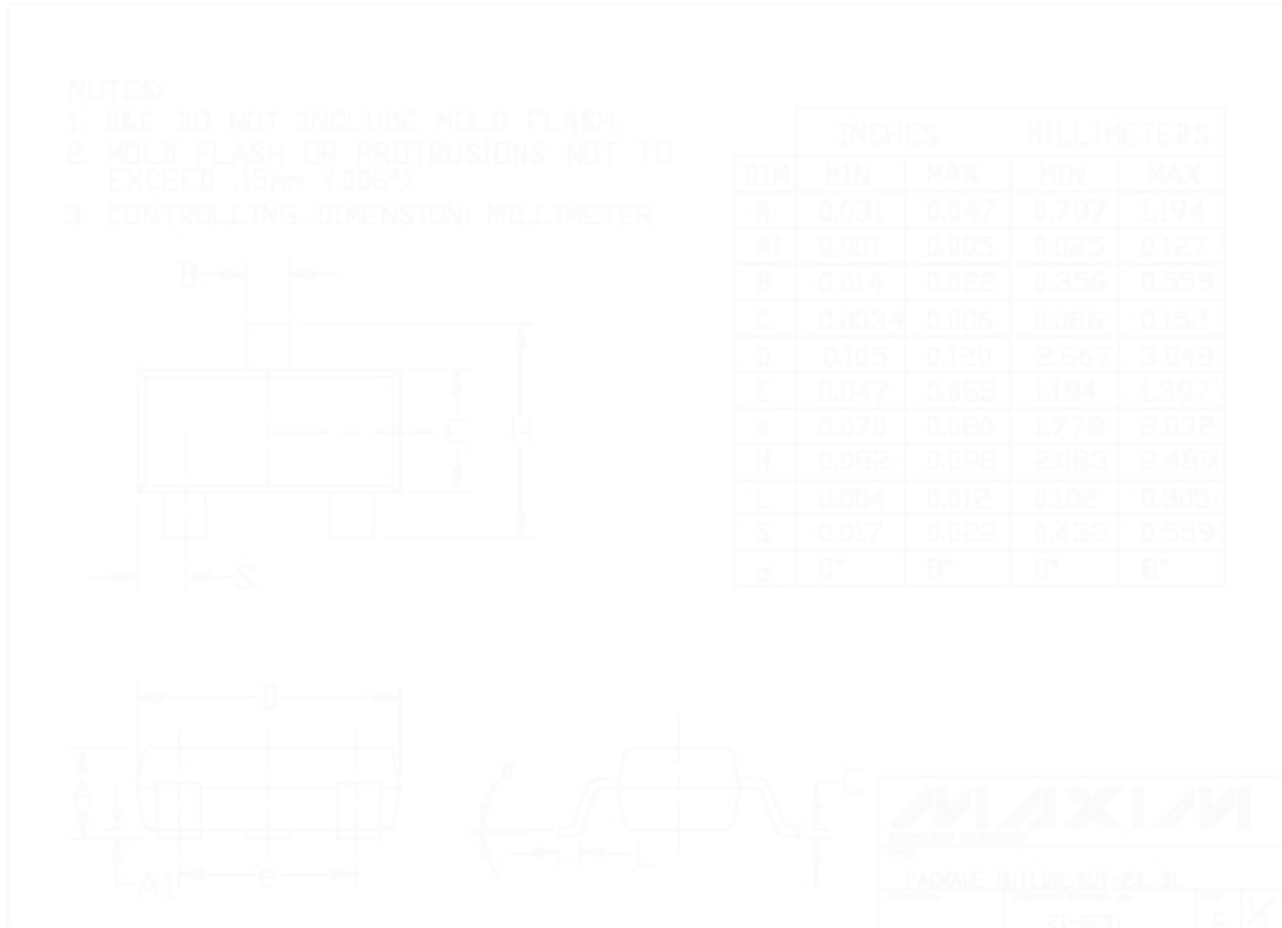

Maxim cannot assume responsibility for use of any circuitry other than circuitry entirely embodied in a Maxim product. No circuit patent licenses are implied. Maxim reserves the right to change the circuitry and specifications without notice at any time.

12 Maxim Integrated Products, 120 San Gabriel Drive, Sunnyvale, CA 94086 408-737-7600