

FAIRCHILD

A Schlumberger Company

2N6757/2N6758
N-Channel Power MOSFETs,
9 A, 150 V/200 V

T-39-11

Power And Discrete Division

Description

These devices are n-channel, enhancement mode, power MOSFETs designed especially for high power, high speed applications, such as switching power supplies, UPS, AC and DC motor controls, relay and solenoid drivers and high energy pulse circuits.

TO-204AA

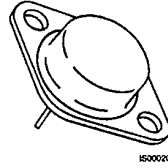

2N6757
 2N6758

- V_{GS} Rated at ±20 V
- Silicon Gate for Fast Switching Speeds
- I_{DSS}, R_{DS(on)}, Specified at Elevated Temperature
- Rugged
- Low Drive Requirements
- Ease of Paralleling

Maximum Ratings

Symbol	Characteristic	Rating 2N6758	Rating 2N6757	Unit
V _{DSS}	Drain to Source Voltage	200	150	V
V _{DGR}	Drain to Gate Voltage R _{GS} = 1 MΩ	200	200	V
V _{GS}	Gate to Source Voltage	±20	±20	V
T _J , T _{stg}	Operating Junction and Storage Temperatures	-55 to +150	-55 to +150	°C
T _L	Maximum Lead Temperature for Soldering Purposes, 1/16" From Case for 10 s	300	300	°C

Maximum On-State Characteristics

R _{DS(on)}	Static Drain-to-Source On Resistance	0.4	0.6	Ω
I _D	Drain Current Continuous at T _C = 25°C	9.0	8.0	A
I _{DM}	Continuous at T _C = 100°C Pulsed	6.0 ² 15 ²	5.0 ² 12 ²	

Maximum Thermal Characteristics

R _{θJC}	Thermal Resistance, Junction to Case	1.67	1.67	°C/W
P _D	Total Power Dissipation at T _C = 25°C	75	75	W
	Linear Derating Factor	0.6	0.6	W/°C

Notes

All values are JEDEC registered except as noted. For information concerning connection diagram and package outline, refer to Section 7.

2

Electrical Characteristics ($T_C = 25^\circ\text{C}$ unless otherwise noted)

Symbol	Characteristic	Min	Max	Unit	Test Conditions
Off Characteristics					
$V_{(BR)DSS}$	Drain Source Breakdown Voltage 2N6758 2N6757			V	$V_{GS} = 0\text{ V}, I_D = 1\text{ mA}$
		200 ²			
		150 ²			
I_{DSS}	Zero Gate Voltage Drain Current		1	mA	$V_{DS} = \text{Rated } V_{DSS}, V_{GS} = 0\text{ V}$
			4		
I_{GSS}	Gate-Body Leakage Current		± 100	nA	$V_{GS} = \pm 20\text{ V}, V_{DS} = 0\text{ V}$
On Characteristics					
$V_{GS(th)}$	Gate Threshold Voltage	2.0	4.0	V	$I_D = 1\text{ mA}, V_{DS} = V_{GS}$
$R_{DS(on)}$	Static Drain-Source On-Resistance 2N6758 2N6757 2N6758 2N6757			Ω	$V_{GS} = 10\text{ V}$ $I_D = 6\text{ A}$ $I_D = 5\text{ A}$ $I_D = 6\text{ A}, T_C = 125^\circ\text{C}$ $I_D = 5\text{ A}, T_C = 125^\circ\text{C}$
			0.4		
			0.6		
			0.75		
			1.13		
$V_{DS(on)}$	Drain-Source On-Voltage ¹ 2N6758 2N6757		3.6	V	$V_{GS} = 10\text{ V}; I_D = 9\text{ A}$ $V_{GS} = 10\text{ V}; I_D = 8\text{ A}$
			4.8		
g_{fs}	Forward Transconductance ¹	3.0	9.0	S (Ω)	$V_{DS} = 15\text{ V}, I_D = 6\text{ A}$
Dynamic Characteristics					
C_{iss}	Input Capacitance	350	800	pF	$V_{DS} = 25\text{ V}, V_{GS} = 0\text{ V}$ $f = 1.0\text{ MHz}$
C_{oss}	Output Capacitance	100	450	pF	
C_{rss}	Reverse Transfer Capacitance	40	150	pF	
Switching Characteristics ($T_C = 25^\circ\text{C}$, Figures 9, 10)					
$t_{d(on)}$	Turn-On Delay Time		30	ns	$V_{DD} = 90\text{ V}, I_D = 6\text{ A}$ $V_{GS} = 10\text{ V}, R_{GEN} = 15\ \Omega$ $R_{GS} = 15\ \Omega$
t_r	Rise Time		50	ns	
$t_{d(off)}$	Turn-Off Delay Time		50	ns	
t_f	Fall Time		40	ns	
Q_g	Total Gate Charge		30 ²	nC	$V_{GS} = 10\text{ V}, I_D = 12\text{ A}$ $V_{DD} = 120\text{ V}$

Electrical Characteristics (Cont.) ($T_C = 25^\circ\text{C}$ unless otherwise noted)

Symbol	Characteristic	Min	Typ	Max	Unit	Test Conditions
Source-Drain Diode Characteristics						
I_S	Continuous Source Current 2N6758 2N6757			9.0 8.0	A	
I_{SM}	Pulsed Source Current 2N6758 2N6757			15 ² 12 ²	A	
V_{SD}	Diode Forward Voltage 2N6758	0.80		1.60	V	$V_{GS} = 0\text{ V}$ $I_S = 9\text{ A}$
	2N6757	0.75		1.50	V	$I_S = 8\text{ A}$
t_{rr}	Reverse Recovery Time		650 ²		ns	$V_{GS} = 0\text{ V}$, $T_J = 150^\circ\text{C}$ $I_F = I_{SM}$, $di_F/dt = 100\text{ A}/\mu\text{S}$
Q_{RR}	Reverse Recovery Charge		10 ²		μC	$V_{GS} = 0\text{ V}$, $T_J = 150^\circ\text{C}$ $I_F = I_{SM}$, $di_F/dt = 100\text{ A}$

Notes

1. Pulse test: Pulse width $\leq 300\ \mu\text{s}$, Duty cycle $\leq 2\%$
2. Non-JEDEC registered value.

Typical Performance Curves

Figure 1 Output Characteristics

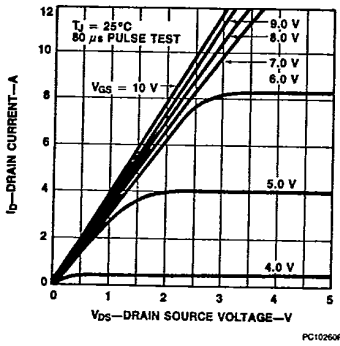
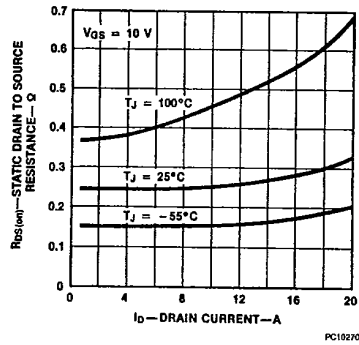

Figure 2 Static Drain to Source Resistance vs Drain Current



Typical Performance Curves (Cont.)

Figure 3 Transfer Characteristics

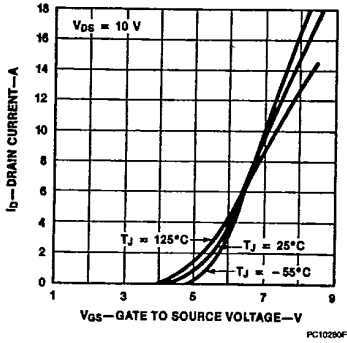

Figure 4 Temperature Variation of Gate to Source Threshold Voltage

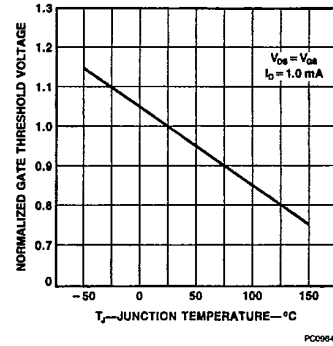

Figure 5 Capacitance vs Drain to Source Voltage

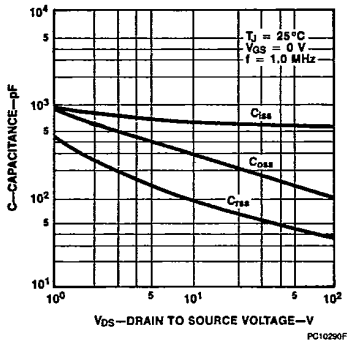

Figure 6 Gate to Source Voltage vs Total Gate Charge

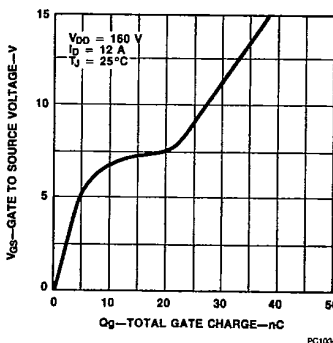

Figure 7 Forward Biased Safe Operating Area

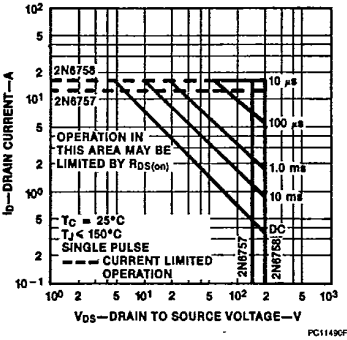
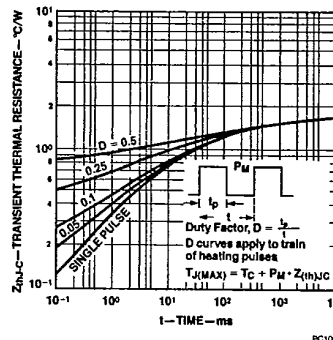

Figure 8 Transient Thermal Resistance vs Time



2N6757/2N6758

T-39-11

Typical Electrical Characteristics

Figure 9 Switching Test Circuit

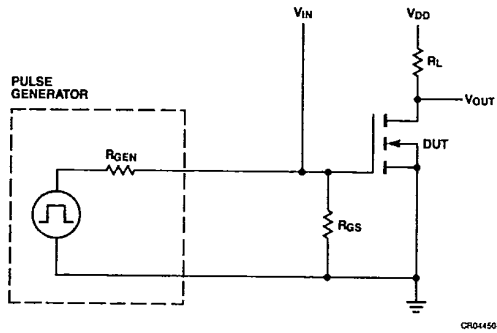

Figure 10 Switching Waveforms

