

Low Noise Pseudomorphic HEMT in a Surface Mount Plastic Package

Technical Data

ATF-38143

Features

- Low Noise Figure
- Excellent Uniformity in Product Specifications
- Low Cost Surface Mount Small Plastic Package SOT-343 (4 lead SC-70)
- Tape-and-Reel Packaging Option Available

Specifications

1.9 GHz; 2 V, 10 mA (Typ.)

- 0.4 dB Noise Figure
- 16 dB Associated Gain
- 12.0 dBm Output Power at 1 dB Gain Compression
- 22.0 dBm Output 3rd Order Intercept

Applications

- Low Noise Amplifier for Cellular/PCS Handsets
- LNA for WLAN, WLL/RLL, LEO, and MMDS Applications
- General Purpose Discrete PHEMT for Other Ultra Low Noise Applications

Surface Mount Package SOT-343

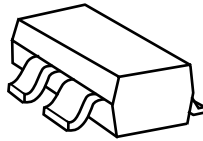

Pin Connections and Package Marking

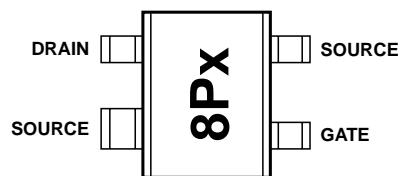

Note: Top View. Package marking provides orientation and identification.

“8P” = Device code

“x” = Date code character. A new character is assigned for each month, year.

Description

Agilent Technologies’s ATF-38143 is a high dynamic range, low noise, PHEMT housed in a 4-lead SC-70 (SOT-343) surface mount plastic package.

Based on its featured performance, ATF-38143 is suitable for applications in cellular and PCS handsets, LEO systems, MMDS, and other systems requiring super low noise figure with good intercept in the 450 MHz to 10 GHz frequency range.

ATF-38143 Absolute Maximum Ratings^[1]

Symbol	Parameter	Units	Absolute Maximum
V_{DS}	Drain - Source Voltage ^[2]	V	4.5
V_{GS}	Gate - Source Voltage	V	-4
V_{GD}	Gate Drain Voltage	V	-4
I_{DS}	Drain Current	mA	I_{dss}
P_{diss}	Total Power Dissipation ^[2]	mW	580
$P_{in\ max}$	RF Input Power	dBm	17
T_{CH}	Channel Temperature	°C	160
T_{STG}	Storage Temperature	°C	-65 to 160
θ_{jc}	Thermal Resistance ^[3]	°C/W	165

Notes:

1. Operation of this device above any one of these parameters may cause permanent damage.
2. Source lead temperature is 25°C. Derate 6 mW/°C for $T_L > 64^\circ\text{C}$.
3. Thermal resistance measured using 150°C Liquid Crystal Measurement method.

Product Consistency Distribution Charts

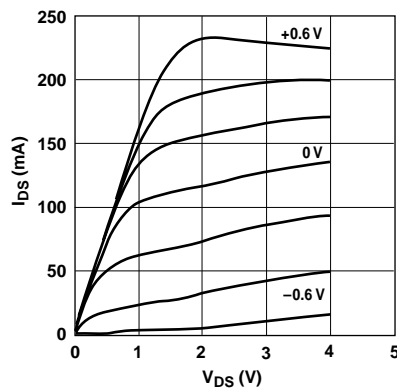

Figure 1. Typical I-V Curves.
($V_{GS} = -0.2\text{ V}$ per step)

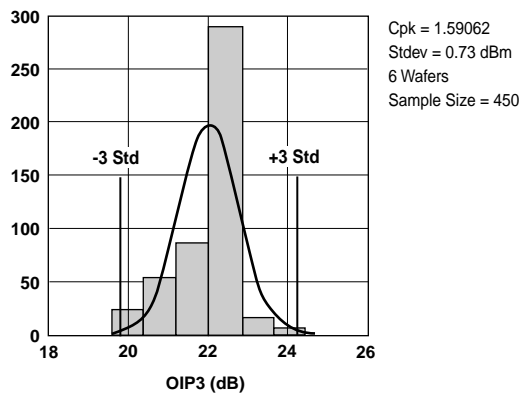

Figure 2. OIP3 @ 2 GHz, 2 V, 10 mA.
LSL=18.5, Nominal=21.99, USL=26.0

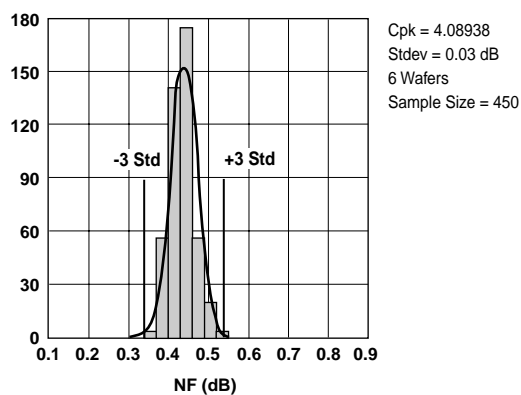

Figure 3. NF @ 2 GHz, 2 V, 10 mA.
LSL=0, Nominal=0.44, USL=0.85

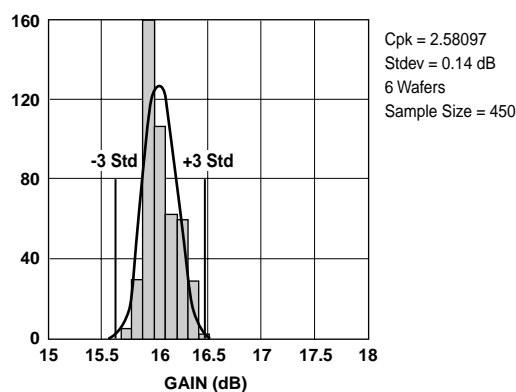

Figure 4. Gain @ 2 GHz, 2 V, 10 mA.
LSL=15.0, Nominal=16.06, USL=18.0

Note:

Distribution data sample size is 450 samples taken from 6 different wafers. Future wafers allocated to this product may have nominal values anywhere within the upper and lower spec limits.

Measurements made on production test board. This circuit represents a trade-off between an optimal noise match and a realizable match based on production test requirements. Circuit losses have been de-embedded from actual measurements.

ATF-38143 Electrical Specifications

$T_A = 25^\circ\text{C}$, RF parameters measured in a test circuit for a typical device

Symbol	Parameters and Test Conditions		Units	Min.	Typ. ^[2]	Max.
$I_{dss}^{[1]}$	Saturated Drain Current $V_{DS} = 1.5\text{ V}, V_{GS} = 0\text{ V}$		mA	90	118	145
$V_P^{[1]}$	Pinchoff Voltage $V_{DS} = 1.5\text{ V}, I_{DS} = 10\% \text{ of } I_{dss}$		V	-0.65	-0.5	-0.35
I_d	Quiescent Bias Current $V_{GS} = -0.54\text{ V}, V_{DS} = 2\text{ V}$		mA	—	10	—
$g_m^{[1]}$	Transconductance $V_{DS} = 1.5\text{ V}, g_m = I_{dss}/V_P$		mmho	180	230	—
I_{GDO}	Gate to Drain Leakage Current $V_{GD} = -5\text{ V}$		μA			500
I_{gss}	Gate Leakage Current $V_{GD} = V_{GS} = -4\text{ V}$		μA	—	30	300
NF	Noise Figure	$f = 2\text{ GHz}$ $V_{DS} = 2\text{ V}, I_{DS} = 5\text{ mA}$ $V_{DS} = 2\text{ V}, I_{DS} = 10\text{ mA}$ $V_{DS} = 2\text{ V}, I_{DS} = 20\text{ mA}$	dB		0.6 0.4 0.3	0.85
		$f = 900\text{ MHz}$ $V_{DS} = 2\text{ V}, I_{DS} = 5\text{ mA}$ $V_{DS} = 2\text{ V}, I_{DS} = 10\text{ mA}$ $V_{DS} = 2\text{ V}, I_{DS} = 20\text{ mA}$	dB		0.6 0.4 0.3	
G_a	Associated Gain ^[3]	$f = 2\text{ GHz}$ $V_{DS} = 2\text{ V}, I_{DS} = 5\text{ mA}$ $V_{DS} = 2\text{ V}, I_{DS} = 10\text{ mA}$ $V_{DS} = 2\text{ V}, I_{DS} = 20\text{ mA}$	dB	15	15.3 16.0 17.0	18
		$f = 900\text{ MHz}$ $V_{DS} = 2\text{ V}, I_{DS} = 5\text{ mA}$ $V_{DS} = 2\text{ V}, I_{DS} = 10\text{ mA}$ $V_{DS} = 2\text{ V}, I_{DS} = 20\text{ mA}$	dB		17.0 19.0 20.5	
OIP3	Output 3 rd Order Intercept Point ^[3]	$f = 2\text{ GHz}$ $V_{DS} = 2\text{ V}, I_{DS} = 10\text{ mA}$	dBm	18.5	22.0	
		$f = 900\text{ MHz}$ $V_{DS} = 2\text{ V}, I_{DS} = 10\text{ mA}$	dBm		22.0	
IIP3	Input 3 rd Order Intercept Point ^[3]	$f = 2\text{ GHz}$ $V_{DS} = 2\text{ V}, I_{DS} = 10\text{ mA}$	dBm		6.0	
		$f = 900\text{ MHz}$ $V_{DS} = 2\text{ V}, I_{DS} = 10\text{ mA}$	dBm		3.0	
P_{1dB}	1 dB Compressed Compressed Power ^[3]	$f = 2\text{ GHz}$ $V_{DS} = 2\text{ V}, I_{DS} = 10\text{ mA}$	dBm		12.0	
		$f = 900\text{ MHz}$ $V_{DS} = 2\text{ V}, I_{DS} = 10\text{ mA}$	dBm		12.0	

Notes:

1. Guaranteed at wafer probe level.
2. Typical value determined from a sample size of 450 parts from 6 wafers.
3. Measurements obtained using production test board described in Figure 5.

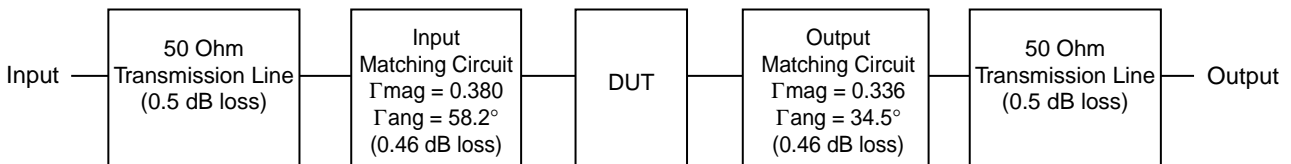

Figure 5. Block diagram of 2 GHz production test board used for Noise Figure, Associated Gain, P_{1dB} , and OIP3 measurements. This circuit represents a trade-off between an optimal noise match and a realizable match based on production test board requirements. Circuit losses have been de-embedded from actual measurements.

ATF-38143 Typical Performance Curves

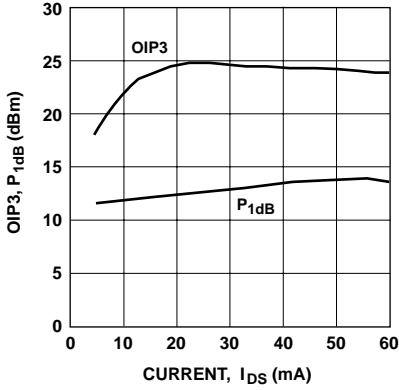

Figure 6. OIP3 and P_{1dB} vs. I_d at 2V, 2 GHz.

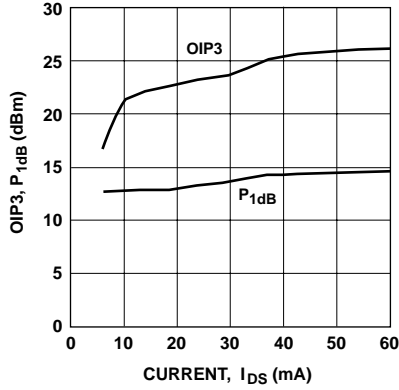

Figure 7. OIP3 and P_{1dB} vs. I_d at 2V, 900 MHz.

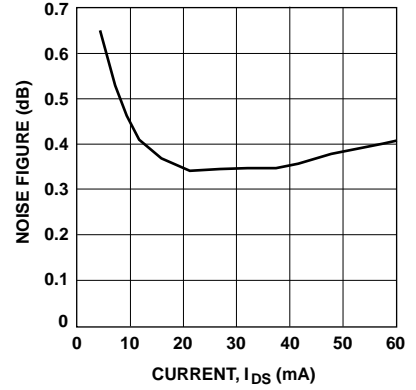

Figure 8. Noise Figure vs. I_d at 2V, 2 GHz.

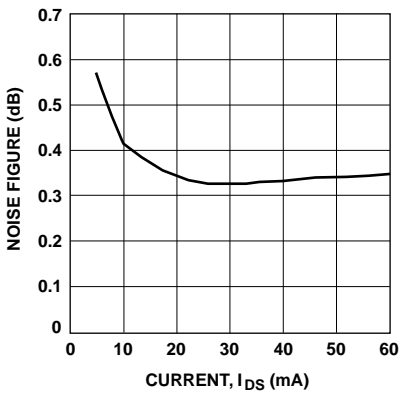

Figure 9. Noise Figure vs. I_d at 2V, 900 MHz.

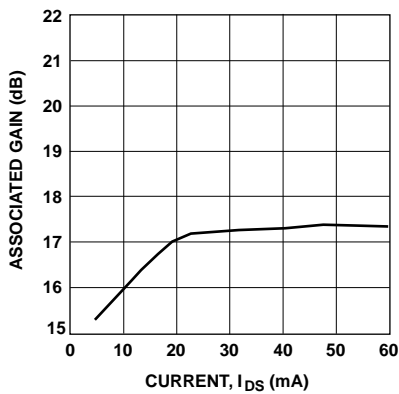

Figure 10. Associated Gain vs. I_d at 2V, 2 GHz.

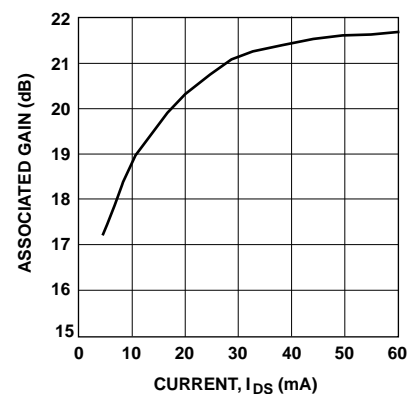

Figure 11. Associated Gain vs. I_d at 2V, 900 MHz.

Notes:

1. Measurements made on a fixed tuned production test board that was tuned for optimal gain match with reasonable noise figure at 2V 10 mA bias. This circuit represents a trade-off between an optimal noise match, maximum gain match and a realizable match based on production test board requirements. Circuit losses have been de-embedded from actual measurements.
2. P_{1dB} measurements are performed with passive biasing. Quiescent drain current, I_{DSQ} , is set with zero RF drive applied. As P_{1dB} is approached, the drain current may increase or decrease depending on frequency and dc bias point. At lower values of I_{DSQ} the device is running closer to class B as power output approaches P_{1dB} . This results in higher P_{1dB} and higher PAE (power added efficiency) when compared to a device that is driven by a constant current source as is typically done with active biasing.

ATF-38143 Typical Performance Curves, continued

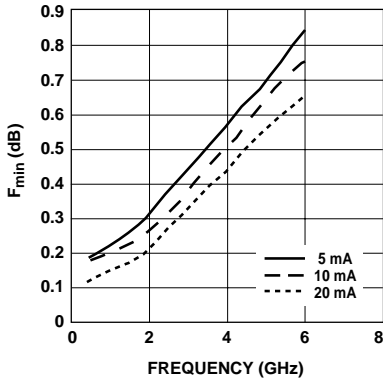

Figure 12. F_{min} vs. Frequency and Current at 2V.

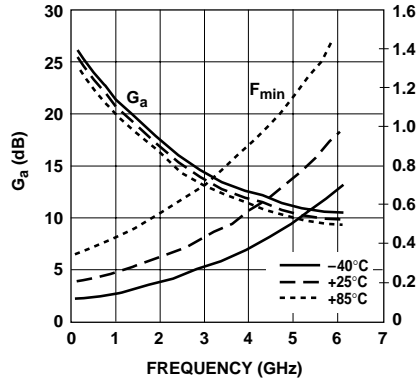

Figure 13. F_{min} and G_a vs. Frequency and Temperature at 2V, 10 mA.

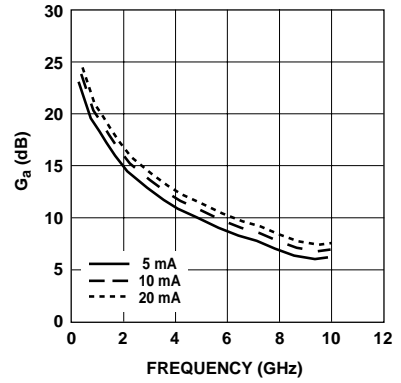

Figure 14. Associated Gain vs. Frequency and Current at 2V.

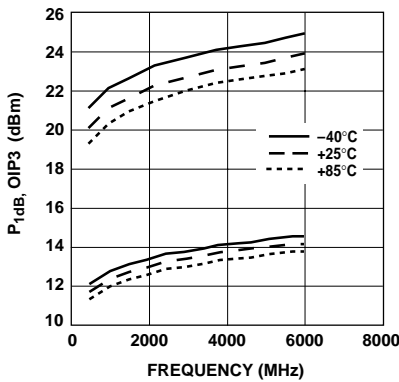

Figure 15. P_{1dB} and OIP3 vs. Frequency and Temperature at 2V, 10 mA.

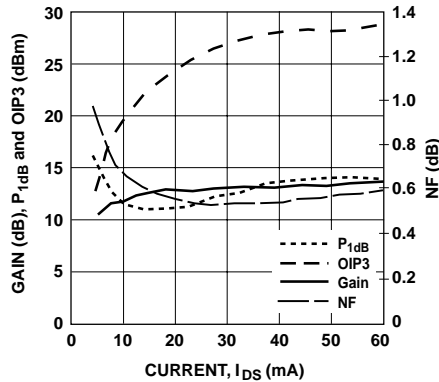

Figure 16. NF, Gain, P_{1dB} and OIP3 vs. I_{DS} at 2V, 3.9 GHz.

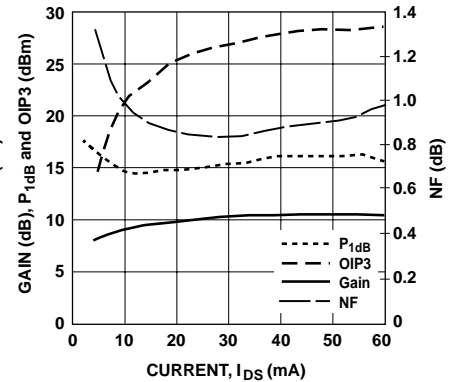

Figure 17. NF, Gain, P_{1dB} and OIP3 vs. I_{DS} at 2V, 5.8 GHz.

Notes:

1. P_{1dB} measurements are performed with passive biasing. Quiescent drain current, I_{DSQ} , is set with zero RF drive applied. As P_{1dB} is approached, the drain current may increase or decrease depending on frequency and dc bias point. At lower values of I_{DSQ} the device is running closer to class B as power output approaches P_{1dB} . This results in higher P_{1dB} and higher PAE (power added efficiency) when compared to a device that is driven by a constant current source as is typically done with active biasing.

ATF-38143 Typical Scattering Parameters, $V_{DS} = 2\text{ V}$, $I_{DS} = 5\text{ mA}$

Freq. (GHz)	S_{11}		S_{21}			S_{12}			S_{22}		MSG/MAG (dB)
	Mag.	Ang.	dB	Mag.	Ang.	dB	Mag.	Ang.	Mag.	Ang.	
0.5	0.98	-25	14.47	5.289	160	-26.56	0.047	73	0.67	-21	20.51
0.8	0.95	-40	14.19	5.122	148	-22.85	0.072	63	0.65	-32	18.52
1.0	0.93	-51	14.00	5.010	140	-21.21	0.087	56	0.62	-40	17.60
1.5	0.87	-75	13.28	4.613	122	-18.49	0.119	41	0.56	-58	15.88
1.8	0.82	-89	12.79	4.362	111	-17.52	0.133	33	0.52	-69	15.16
2.0	0.80	-98	12.45	4.192	105	-16.95	0.142	28	0.50	-77	14.70
2.5	0.75	-120	11.48	3.751	89	-16.19	0.155	16	0.44	-94	13.84
3.0	0.71	-139	10.48	3.342	76	-15.70	0.164	5	0.40	-110	13.09
4.0	0.67	-170	8.68	2.716	52	-15.44	0.169	-12	0.34	-138	12.06
5.0	0.66	162	7.24	2.302	30	-15.44	0.169	-27	0.31	-162	11.34
6.0	0.66	137	6.02	2.000	10	-15.60	0.166	-41	0.29	173	10.81
7.0	0.68	113	4.78	1.734	-10	-15.92	0.160	-55	0.28	146	10.35
8.0	0.70	92	3.51	1.498	-29	-16.59	0.148	-67	0.29	121	8.89
9.0	0.72	73	2.39	1.316	-47	-17.20	0.138	-77	0.32	103	7.33
10.0	0.74	56	1.51	1.190	-64	-17.46	0.134	-86	0.37	87	6.93
11.0	0.78	39	0.44	1.052	-83	-17.86	0.128	-97	0.42	66	6.66
12.0	0.82	23	-0.73	0.919	-100	-18.42	0.120	-106	0.47	47	6.22
13.0	0.83	10	-2.17	0.779	-117	-19.33	0.108	-115	0.52	28	4.93
14.0	0.85	-2	-3.54	0.665	-132	-20.00	0.100	-121	0.57	11	3.95
15.0	0.87	-16	-4.84	0.573	-147	-20.45	0.095	-129	0.63	0	3.58
16.0	0.88	-30	-6.16	0.492	-161	-20.82	0.091	-136	0.68	-12	2.90
17.0	0.88	-39	-7.51	0.421	-176	-21.11	0.088	-145	0.71	-26	1.98
18.0	0.89	-50	-9.07	0.352	173	-21.83	0.081	-151	0.75	-37	1.24

ATF-38143 Typical Noise Parameters

$V_{DS} = 2\text{ V}$, $I_{DS} = 5\text{ mA}$

Freq. GHz	F_{min} dB	Γ_{opt}		$R_{n/50}$ -	G_a dB
		Mag.	Ang.		
0.5	0.18	0.69	14	0.25	23.0
0.9	0.21	0.69	26	0.23	20.5
1.0	0.22	0.68	27	0.22	19.8
1.5	0.26	0.68	44	0.20	17.1
1.8	0.29	0.66	59	0.17	16.0
2.0	0.32	0.65	61	0.17	15.4
2.5	0.40	0.62	80	0.14	14.3
3.0	0.48	0.59	98	0.11	13.1
4.0	0.60	0.50	127	0.08	10.8
5.0	0.70	0.49	163	0.04	9.8
6.0	0.84	0.51	-169	0.04	8.7
7.0	0.96	0.53	-140	0.09	7.7
8.0	1.12	0.54	-111	0.20	6.8
9.0	1.27	0.59	-88	0.36	6.1
10.0	1.38	0.62	-68	0.60	6.0

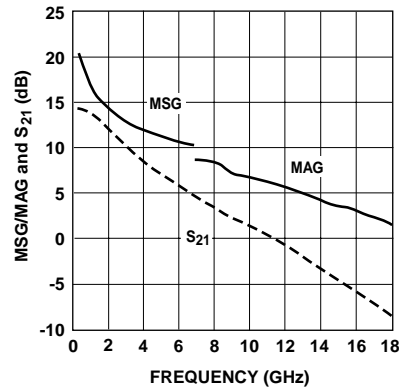

Figure 18. MSG/MAG and $|S_{21}|^2$ vs. Frequency at 2 V, 5 mA.

Notes:

- F_{min} values are based on a set of 16 noise figure measurements made at 16 different impedances using an ATN NP5 test system. From these measurements a true F_{min} is calculated. Refer to the noise parameter application section for more information.
- S and noise parameters are measured on a microstrip line made on 0.025 inch thick alumina carrier. The input reference plane is at the end of the gate lead. The output reference plane is at the end of the drain lead. The parameters include the effect of four plated through via holes connecting source landing pads on top of the test carrier to the microstrip ground plane on the bottom side of the carrier. Two 0.020 inch diameter via holes are placed within 0.010 inch from each source lead contact point, one via on each side of that point.

ATF-38143 Typical Scattering Parameters, $V_{DS} = 2\text{ V}$, $I_{DS} = 10\text{ mA}$

Freq. (GHz)	S_{11}		S_{21}			S_{12}			S_{22}		MSG/MAG (dB)
	Mag.	Ang.	dB	Mag.	Ang.	dB	Mag.	Ang.	Mag.	Ang.	
0.5	0.97	-29	17.41	7.423	158	-27.74	0.041	72	0.53	-26	22.58
0.8	0.93	-47	17.00	7.081	145	-24.01	0.063	61	0.51	-40	20.51
1.0	0.91	-58	16.69	6.834	136	-22.50	0.075	55	0.48	-50	19.60
1.5	0.83	-85	15.69	6.086	117	-20.00	0.100	40	0.42	-72	17.84
1.8	0.78	-100	15.02	5.634	107	-19.17	0.110	33	0.39	-85	17.09
2.0	0.76	-109	14.57	5.350	100	-18.71	0.116	28	0.37	-94	16.64
2.5	0.71	-131	13.38	4.665	86	-17.99	0.126	18	0.33	-114	15.68
3.0	0.68	-150	12.22	4.083	73	-17.65	0.131	9	0.31	-132	14.94
4.0	0.65	180	10.24	3.251	50	-17.27	0.137	-5	0.28	-163	13.75
5.0	0.65	153	8.68	2.716	30	-17.08	0.140	-18	0.28	172	12.88
6.0	0.66	129	7.35	2.330	11	-16.95	0.142	-30	0.28	147	12.15
7.0	0.68	107	6.03	2.003	-9	-16.95	0.142	-42	0.29	122	11.49
8.0	0.71	87	4.72	1.722	-27	-17.27	0.137	-53	0.32	99	9.09
9.0	0.73	68	3.57	1.509	-43	-17.46	0.134	-62	0.35	83	7.94
10.0	0.75	53	2.71	1.366	-60	-17.27	0.137	-72	0.40	70	7.55
11.0	0.79	36	1.61	1.204	-78	-17.39	0.135	-83	0.45	52	7.27
12.0	0.82	20	0.47	1.055	-94	-17.65	0.131	-94	0.50	35	6.84
13.0	0.84	8	-0.93	0.898	-110	-18.34	0.121	-104	0.54	17	5.72
14.0	0.85	-4	-2.24	0.773	-125	-18.86	0.114	-112	0.59	2	4.77
15.0	0.87	-18	-3.45	0.672	-140	-19.17	0.110	-122	0.63	-8	4.42
16.0	0.88	-31	-4.63	0.587	-153	-19.49	0.106	-131	0.67	-19	3.85
17.0	0.88	-41	-5.81	0.512	-167	-19.74	0.103	-141	0.70	-32	3.03
18.0	0.89	-51	-7.27	0.433	-179	-20.54	0.094	-148	0.74	-41	2.34

ATF-38143 Typical Noise Parameters

$V_{DS} = 2\text{ V}$, $I_{DS} = 10\text{ mA}$

Freq. GHz	F_{min} dB	Γ_{opt}		$R_{n/50}$ -	G_a dB
		Mag.	Ang.		
0.5	0.18	0.66	13	0.17	24.1
0.9	0.19	0.64	22	0.16	21.0
1.0	0.20	0.63	26	0.15	20.4
1.5	0.23	0.60	43	0.14	17.9
1.8	0.25	0.57	60	0.12	17.0
2.0	0.28	0.56	67	0.12	16.1
2.5	0.32	0.54	81	0.10	15.2
3.0	0.39	0.52	98	0.08	13.9
4.0	0.52	0.44	129	0.06	11.9
5.0	0.65	0.44	166	0.04	10.8
6.0	0.75	0.45	-165	0.04	9.6
7.0	0.84	0.48	-135	0.08	8.7
8.0	0.95	0.51	-106	0.16	7.7
9.0	1.10	0.55	-84	0.29	7.0
10.0	1.20	0.56	-65	0.46	6.8

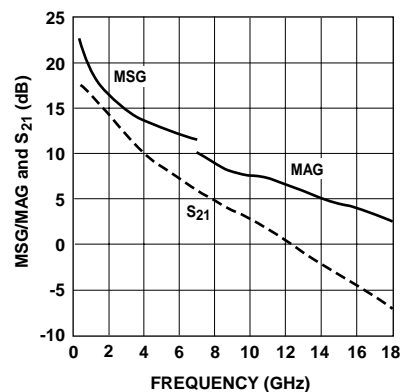

Figure 19. MSG/MAG and $|S_{21}|^2$ vs. Frequency at 2 V, 10 mA.

Notes:

- F_{min} values are based on a set of 16 noise figure measurements made at 16 different impedances using an ATN NP5 test system. From these measurements a true F_{min} is calculated. Refer to the noise parameter application section for more information.
- S and noise parameters are measured on a microstrip line made on 0.025 inch thick alumina carrier. The input reference plane is at the end of the gate lead. The output reference plane is at the end of the drain lead. The parameters include the effect of four plated through via holes connecting source landing pads on top of the test carrier to the microstrip ground plane on the bottom side of the carrier. Two 0.020 inch diameter via holes are placed within 0.010 inch from each source lead contact point, one via on each side of that point.

ATF-38143 Typical Scattering Parameters, $V_{DS} = 2\text{ V}$, $I_{DS} = 20\text{ mA}$

Freq. (GHz)	S_{11}		S_{21}			S_{12}			S_{22}		MSG/MAG (dB)
	Mag.	Ang.	dB	Mag.	Ang.	dB	Mag.	Ang.	Mag.	Ang.	
0.5	0.96	-33	19.50	9.436	155	-28.87	0.036	71	0.39	-33	24.18
0.8	0.91	-53	18.94	8.850	141	-25.19	0.055	60	0.37	-50	22.07
1.0	0.88	-65	18.51	8.425	132	-23.74	0.065	54	0.35	-63	21.13
1.5	0.79	-93	17.23	7.269	113	-21.41	0.085	41	0.31	-90	19.32
1.8	0.75	-109	16.41	6.616	103	-20.63	0.093	34	0.29	-106	18.52
2.0	0.73	-119	15.88	6.220	97	-20.26	0.097	30	0.29	-116	18.07
2.5	0.68	-140	14.52	5.321	83	-19.58	0.105	21	0.27	-139	17.05
3.0	0.66	-159	13.26	4.604	70	-19.09	0.111	14	0.27	-157	16.18
4.0	0.64	172	11.16	3.616	49	-18.49	0.119	2	0.28	174	14.83
5.0	0.64	147	9.52	2.992	30	-17.99	0.126	-9	0.29	151	13.76
6.0	0.66	124	8.12	2.548	11	-17.52	0.133	-20	0.31	129	12.82
7.0	0.68	103	6.77	2.179	-8	-17.33	0.136	-32	0.34	107	11.08
8.0	0.71	83	5.41	1.864	-25	-17.39	0.135	-43	0.37	87	9.34
9.0	0.73	65	4.25	1.632	-41	-17.27	0.137	-53	0.40	73	8.33
10.0	0.76	50	3.39	1.478	-57	-16.95	0.142	-63	0.44	61	7.91
11.0	0.80	34	2.27	1.299	-74	-16.89	0.143	-76	0.50	44	7.63
12.0	0.83	18	1.11	1.136	-90	-17.14	0.139	-87	0.55	28	7.20
13.0	0.85	6	-0.26	0.971	-106	-17.72	0.130	-98	0.58	11	6.20
14.0	0.86	-5	-1.51	0.840	-120	-18.13	0.124	-107	0.62	-4	5.32
15.0	0.88	-19	-2.69	0.734	-134	-18.42	0.120	-118	0.67	-13	5.01
16.0	0.89	-32	-3.80	0.646	-147	-18.79	0.115	-127	0.69	-24	4.34
17.0	0.89	-42	-4.91	0.568	-161	-19.02	0.112	-138	0.71	-36	3.57
18.0	0.90	-52	-6.29	0.485	-173	-19.83	0.102	-146	0.74	-46	2.94

ATF-38143 Typical Noise Parameters

$V_{DS} = 2\text{ V}$, $I_{DS} = 20\text{ mA}$

Freq. GHz	F_{min} dB	Γ_{opt}		$R_{n/50}$ -	G_a dB
		Mag.	Ang.		
0.5	0.15	0.71	13	0.13	24.8
0.9	0.16	0.68	22	0.12	21.4
1.0	0.16	0.66	26	0.12	21.0
1.5	0.18	0.60	43	0.09	19.0
1.8	0.20	0.55	55	0.09	18.0
2.0	0.22	0.51	68	0.09	16.9
2.5	0.28	0.48	82	0.08	15.5
3.0	0.33	0.46	100	0.06	14.7
4.0	0.45	0.37	133	0.05	12.6
5.0	0.56	0.39	172	0.04	11.4
6.0	0.65	0.40	-159	0.04	10.2
7.0	0.72	0.44	-129	0.08	9.3
8.0	0.82	0.48	-100	0.15	8.3
9.0	0.90	0.52	-79	0.26	7.5
10.0	1.00	0.60	-61	0.40	7.3

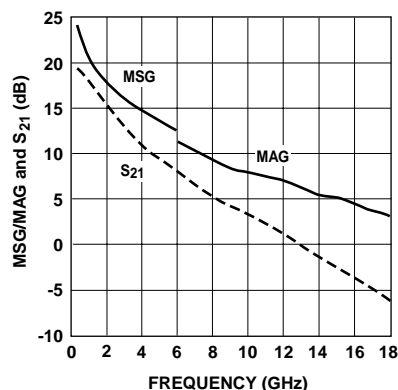

Figure 20. MSG/MAG and $|S_{21}|^2$ vs. Frequency at 2 V, 20 mA.

Notes:

- F_{min} values are based on a set of 16 noise figure measurements made at 16 different impedances using an ATN NP5 test system. From these measurements a true F_{min} is calculated. Refer to the noise parameter application section for more information.
- S and noise parameters are measured on a microstrip line made on 0.025 inch thick alumina carrier. The input reference plane is at the end of the gate lead. The output reference plane is at the end of the drain lead. The parameters include the effect of four plated through via holes connecting source landing pads on top of the test carrier to the microstrip ground plane on the bottom side of the carrier. Two 0.020 inch diameter via holes are placed within 0.010 inch from each source lead contact point, one via on each side of that point.

Noise Parameter

Applications Information

F_{\min} values at 2 GHz and higher are based on measurements while the F_{\min} s below 2 GHz have been extrapolated. The F_{\min} values are based on a set of 16 noise figure measurements made at 16 different impedances using an ATN NP5 test system. From these measurements, a true F_{\min} is calculated. F_{\min} represents the true minimum noise figure of the device when the device is presented with an impedance matching network that transforms the source impedance, typically 50Ω, to an impedance represented by the reflection coefficient Γ_o . The designer must design a matching network that will present Γ_o to the device with minimal associated circuit losses. The noise figure of the completed amplifier is equal to the noise figure of the device plus the losses of the matching network preceding the device. The noise figure of the device is equal to F_{\min} only when the device is

presented with Γ_o . If the reflection coefficient of the matching network is other than Γ_o , then the noise figure of the device will be greater than F_{\min} based on the following equation.

$$NF = F_{\min} + \frac{4 R_n}{Z_o} \frac{|\Gamma_s - \Gamma_o|^2}{(1 + |\Gamma_o|^2)(1 - |\Gamma_s|^2)}$$

Where R_n/Z_o is the normalized noise resistance, Γ_o is the optimum reflection coefficient required to produce F_{\min} and Γ_s is the reflection coefficient of the source impedance actually presented to the device. The losses of the matching networks are non-zero and they will also add to the noise figure of the device creating a higher amplifier noise figure. The losses of the matching networks are related to the Q of the components and associated printed circuit board loss. Γ_o is typically fairly low at higher frequencies and increases as frequency is lowered. Larger gate width devices will typically have a lower Γ_o as compared to narrower gate width devices.

Typically for FETs, the higher Γ_o usually infers that an impedance much higher than 50Ω is required for the device to produce F_{\min} . At VHF frequencies and even lower L Band frequencies, the required impedance can be in the vicinity of several thousand ohms. Matching to such a high impedance requires very hi-Q components in order to minimize circuit losses. As an example at 900 MHz, when air-wound coils ($Q > 100$) are used for matching networks, the loss can still be up to 0.25 dB which will add directly to the noise figure of the device. Using multi-layer molded inductors with Qs in the 30 to 50 range results in additional loss over the air-wound coil. Losses as high as 0.5 dB or greater add to the typical 0.15 dB F_{\min} of the device creating an amplifier noise figure of nearly 0.65 dB. A discussion concerning calculated and measured circuit losses and their effect on amplifier noise figure is covered in Agilent Application 1085.

ATF-38143 SC70 4 Lead, High Frequency Nonlinear Model

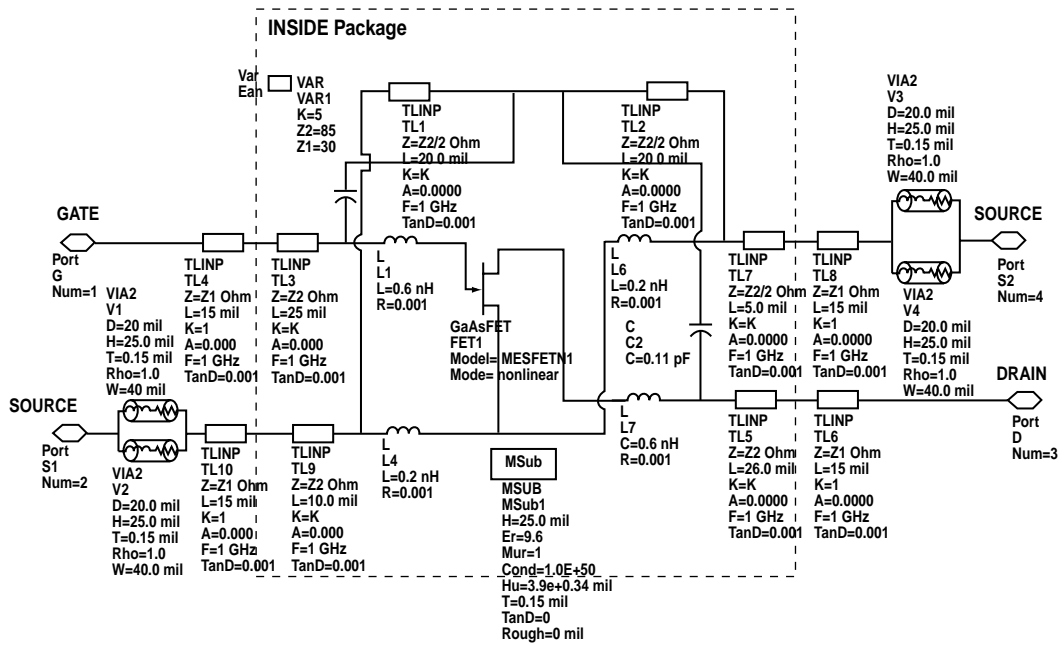

The vias are not part of the model as such. They are only included to account for the source vias in the test fixture.

ATF-38143 Die Model

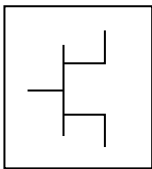

Statz Model

MESFETM1

NFET=yes

PFET=no

Vto=-0.75

Beta=0.3

Lambda=0.07

Alpha=4

B=0.8

Tnom=27

Idstc=

Vbi=0.7

Tau=

Betatce=

Delta1=

Delta2=

Gscap=3

Cgs=0.997 pF

Gdcap=3

Cgd=0.176 pF

Rgd=0.195

Tqm=

Vmax=

Fc=

Rd=0.084

Rg=0.264

Rs=0.054

Ld=0.0014 nH

Lg=0.0883 nH

Ls=0.001 nH

Cds=0.0911 pF

Crf=0.0936

Rc=137

Gsfwd=1

Gsrev=0

Gdfwd=1

Gdrev=0

Vjr=1

Is=1 nA

Ir=1 nA

Imax=0.1

Xti=

N=

Eg=

Vbr=

Vtotc=

Rin=

Taumd1=no

Fnc=1E6

R=0.17

C=0.2

P=1

wVgfwd=

wBvgs=

wBvgd=

wBvds=

wldsmax=

wPmax=

All Params=

Part Number Ordering Information

Part Number	No. of Devices	Container
ATF-38143-TR1	3000	7" Reel
ATF-38143-TR2	10000	13" Reel
ATF-38143-BLK	100	antistatic bag

Package Dimensions

Outline 43 (SOT-343/SC-70 4 lead)

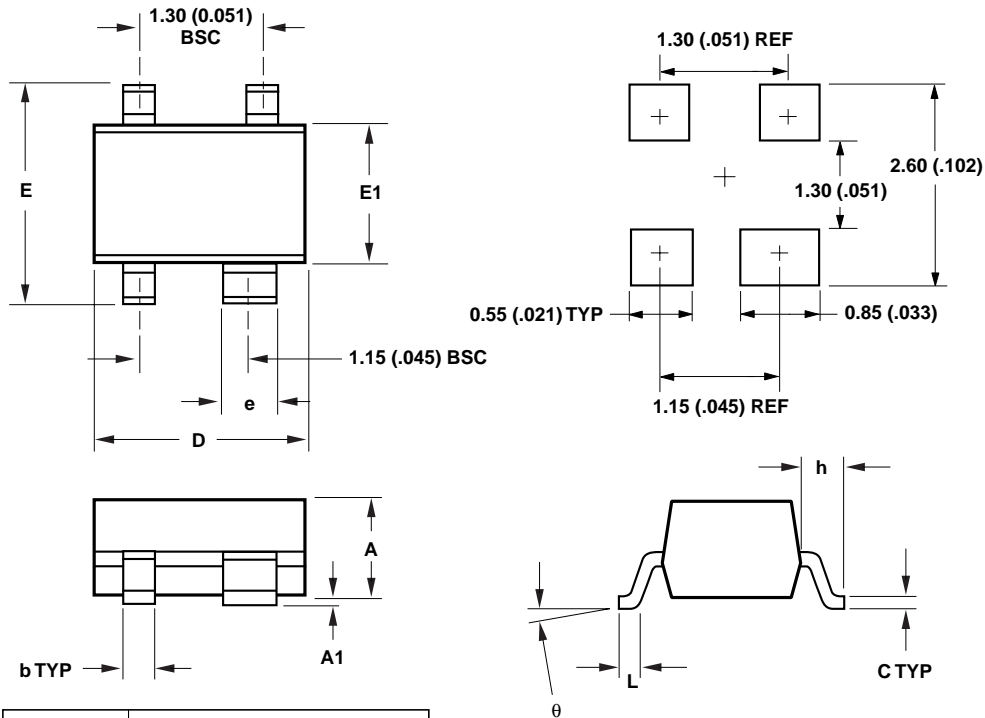

SYMBOL	DIMENSIONS	
	MIN.	MAX.
A	0.80 (0.031)	1.00 (0.039)
A1	0 (0)	0.10 (0.004)
b	0.25 (0.010)	0.35 (0.014)
C	0.10 (0.004)	0.20 (0.008)
D	1.90 (0.075)	2.10 (0.083)
E	2.00 (0.079)	2.20 (0.087)
e	0.55 (0.022)	0.65 (0.025)
h	0.450 TYP (0.018)	
E1	1.15 (0.045)	1.35 (0.053)
L	0.10 (0.004)	0.35 (0.014)
θ	0	10

DIMENSIONS ARE IN MILLIMETERS (INCHES)

Device Orientation

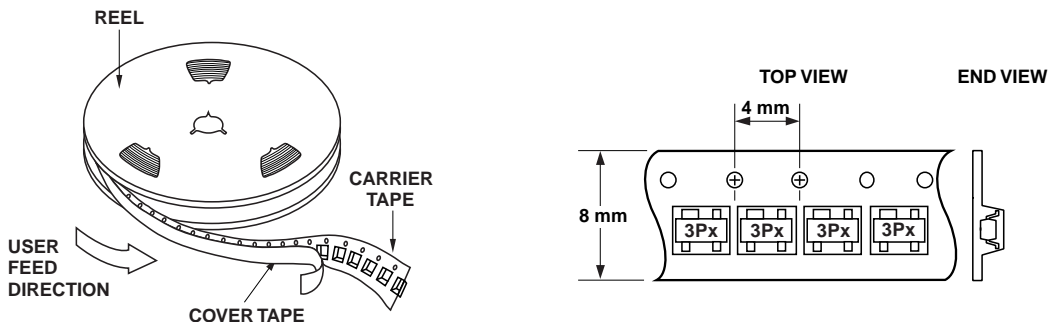

Tape Dimensions For Outline 4T

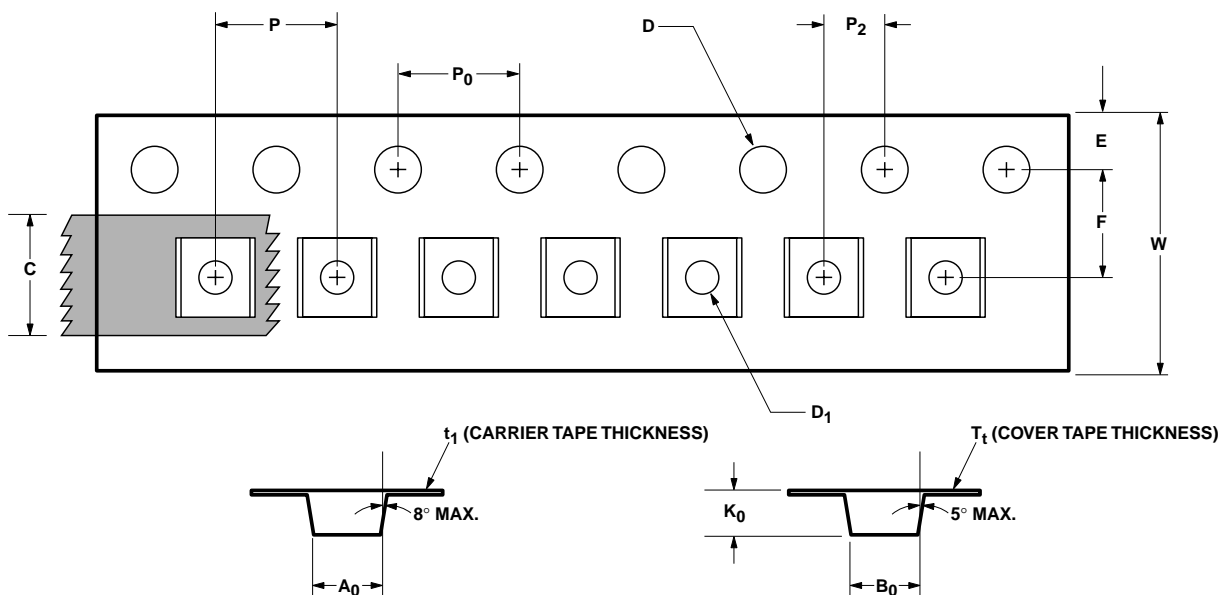

	DESCRIPTION	SYMBOL	SIZE (mm)	SIZE (INCHES)
CAVITY	LENGTH	A_0	2.24 ± 0.10	0.088 ± 0.004
	WIDTH	B_0	2.34 ± 0.10	0.092 ± 0.004
	DEPTH	K_0	1.22 ± 0.10	0.048 ± 0.004
	PITCH	P	4.00 ± 0.10	0.157 ± 0.004
	BOTTOM HOLE DIAMETER	D_1	1.00 ± 0.25	0.039 ± 0.010
PERFORATION	DIAMETER	D	1.55 ± 0.05	0.061 ± 0.002
	PITCH	P_0	4.00 ± 0.10	0.157 ± 0.004
	POSITION	E	1.75 ± 0.10	0.069 ± 0.004
CARRIER TAPE	WIDTH	W	8.00 ± 0.30	0.315 ± 0.012
	THICKNESS	t_1	0.255 ± 0.013	0.010 ± 0.0005
COVER TAPE	WIDTH	C	5.4 ± 0.10	0.205 ± 0.004
	TAPE THICKNESS	T_t	0.062 ± 0.001	0.0025 ± 0.00004
DISTANCE	CAVITY TO PERFORATION (WIDTH DIRECTION)	F	3.50 ± 0.05	0.138 ± 0.002
	CAVITY TO PERFORATION (LENGTH DIRECTION)	P_2	2.00 ± 0.05	0.079 ± 0.002



Agilent Technologies

Innovating the HP Way



www.semiconductor.agilent.com

Data subject to change.

Copyright © 2000 Agilent Technologies, Inc.

5968-7868E (2/00)

当社半導体部品のご使用にあたって

仕様及び仕様書に関して

- ・本仕様は製品改善および技術改良等により予告なく変更する場合があります。ご使用の際には最新の仕様を問い合わせの上、用途のご確認をお願いいたします。
- ・本仕様記載内容を無断で転載または複写することは禁じられております。
- ・本仕様内でご紹介している応用例(アプリケーション)は当社製品がご使用できる代表的なものです。ご使用において第三者の知的財産権などの保証または実施権の許諾に対して問題が発生した場合、当社はその責任を負いかねます。
- ・仕様書はメーカーとユーザ間で交わされる製品に関する使用条件や誤使用防止事項を言及するものです。仕様書の条件外で保存、使用された場合に動作不良、機械不良が発生しても当社は責任を負いかねます。ただし、当社は納品後1年以内に当社の責任に帰すべき理由で、不良或いは故障が発生した場合、無償で製品を交換いたします。
- ・仕様書の製品が製造上および政策上の理由で満足できない場合には変更の権利を当社が有し、その交渉は当社の要求によりすみやかに行われることとさせていただきます。なお、基本的に変更は3ヶ月前、廃止は1年前にご連絡致しますが、例外もございますので予めご了承ください。

ご使用用途に関して

- ・当社の製品は、一般的な電子機器(コンピュータ、OA機器、通信機器、AV機器、家電製品、アミューズメント機器、計測機器、一般産業機器など)の一部に組み込まれて使用されるものです。極めて高い信頼性と安全性が要求される用途(輸送機器、航空・宇宙機器、海底中継器、原子力制御システム、生命維持のための医療機器などの財産・環境もしくは生命に悪影響を及ぼす可能性を持つ用途)を意図し、設計も製造もされているものではありません。それゆえ、本製品の安全性、品質および性能に関しては、仕様書(又は、カタログ)に記載してあること以外は明示的にも黙示的にも一切の保証をするものではありません。

回路設計上のお願い

- ・当社は品質、信頼性の向上に努力しておりますが、一般的に半導体製品の誤動作や、故障の発生は避けられません。本製品の使用に附随し、或いはこれに関連する誤動作、故障、寿命により、他人の生命又は財産に被害や悪影響を及ぼし、或いは本製品を取り付けまたは使用した設備、施設または機械器具に故障が生じ一般公衆に被害を起こしても、当社はその内容、程度を問わず、一切の責任を負いかねます。
お客様の責任において、装置の安全設計をお願いいたします。