

## TA7232P

T-74-05-01

## DUAL AUDIO POWER AMPLIFIER

The TA7232P is a dual audio power amplifier for consumer applications.

It is suitable for power amplifier of portable stereo radio cassette and stereo receiver etc.

- Capability of Dual and BTL Connection
  - Dual Mode :  $P_{OUT}=2.2W$  (Typ.)/CH  
at  $V_{CC}=9V$ , THD=10%,  $R_L=4\Omega$
  - BTL Mode :  $P_{OUT}=5.5W$  (Typ.)  
at  $V_{CC}=9V$ , THD=10%,  $R_L=4\Omega$
- Very Few External Parts
- SIP (Single In-line Package) :
  - Small Package and Easy Patterning
- Excellent Ripple Rejection Ratio :
  - $R.R=60dB$  (Typ.) at  $R_g=0$ ,  $f=100Hz$
- Wide Operating Supply Voltage Range :  $V_{CC}=3.5 \sim 12V$

Unit in mm

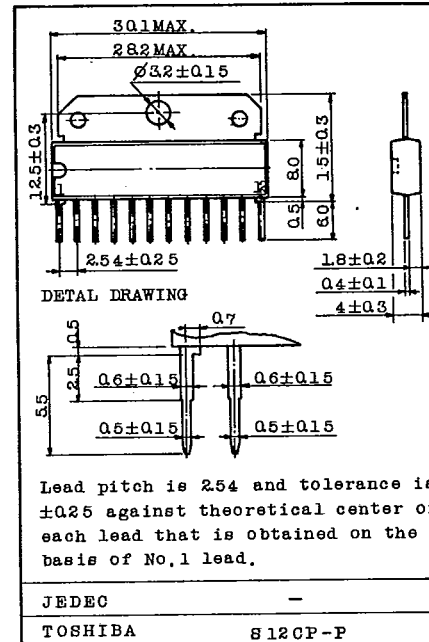
MAXIMUM RATINGS ( $T_a=25^\circ C$ )

CHARACTERISTIC	SYMBOL	RATING	UNIT
Supply Voltage	$V_{CC}$	16	V
Output Current (Peak/CH)	$I_O(\text{peak})$	2	A
Power Dissipation	$P_D$	12.5	W
Operating Temperature	$T_{opr}$	-20 ~ 75	$^\circ C$
Storage Temperature	$T_{stg}$	-55 ~ 150	$^\circ C$

AUDIO LINEAR IC

**TA7232P**

T-74-05-01

## ELECTRICAL CHARACTERISTICS

(Unless otherwise specified,  $V_{CC}=9V$ ,  $R_L=4\Omega$ ,  $R_g=600\Omega$ ,  $f=1kHz$ ,  $T_a=25^\circ C$  Dual Mode)

CHARACTERISTIC	SYMBOL	TEST CIR-CUIT	TEST CONDITION	MIN.	TYP.	MAX.	UNIT
Quiescent Current	ICCQ	-	-	-	22	45	mA
Output Power	POUT	-	THD=10%	1.8	2.2	-	W
			BTL THD=10%	-	5.5	-	
Total Harmonic Distortion	THD	-	POUT=1W/ch	-	0.2	1.0	%
Closed Loop Voltage Gain	Gv	-	$R_f=150\Omega$	42.5	44.5	46.5	dB
			$R_f=0$	52.5	55.5	58.5	
Input Resistance	RIN	-	-	-	20	-	k $\Omega$
Output Noise Voltage	VNO	-	$R_g=10k\Omega$ BW=50Hz ~ 20kHz	-	0.3	0.8	mV <sub>rms</sub>
Ripple Rejection Ratio	R.R	-	$R_g=0$ fripple=100Hz	-	60	-	dB
Cross Talk	CT	-	$R_g=10k\Omega$ , AMP. 1→2 $V_O=0dB$ , $f=1kHz$	-	-52	-	dB

## OUTPUT POWER TABLE (TYPICAL VALUE)

(THD=10%,  $f=1kHz$ ,  $T_a=25^\circ C$ ,  $80cm^2 \times 2mm$  Al Heat Sink)

LOAD		VCC	6V	7.5V	9V	12V
DUAL	$R_L=8\Omega$		0.6W/ch	1W/ch	1.4W/ch	2.5W/ch
	$R_L=4\Omega$		1W/ch	1.5W/ch	2.2W/ch	3.7W/ch
BTL	$R_L=8\Omega$		1.8W	3W	4.5W	7.6W
	$R_L=4\Omega$		2.4W	3.8W	5.5W	*

\* This IC is not available at  $V_{CC}=12V$ ,  $R_L=4\Omega$ , BTL connection, because of power dissipation over.

**TOSHIBA**

# TA7232P

T-74-05-01

## TEST CIRCUIT

. DUAL MODE

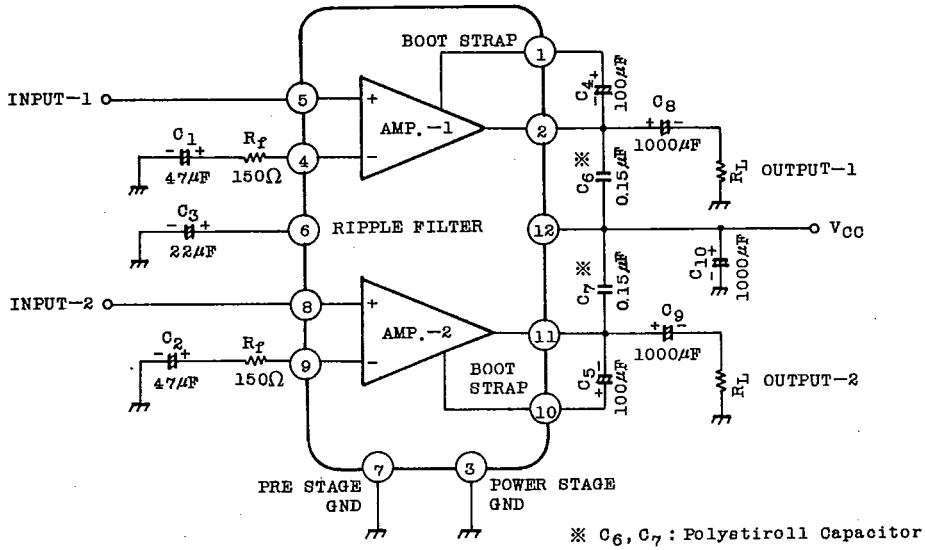

. BTL CONNECTION MODE

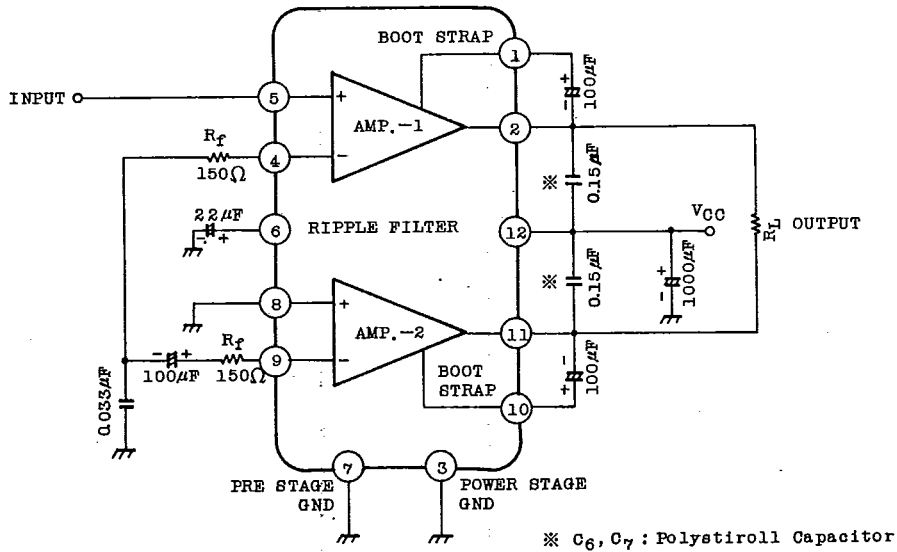

AUDIO LINEAR IC

**TA7232P**

T-74-05-01

## APPLICATION INFORMATION

## 1. GND Pattern

There are two GND terminals in this IC. The pin ⑦ is a input-side GND and the pin ③ is a power transistor GND. It is need to arrange that the GND line so that the common impedance may not exist. An inappropriate GND pattern cause parastic oscillation or increased distortion.

2. Capacitor C<sub>6</sub>,C<sub>7</sub>

The purpose of capacitor C<sub>6</sub>,C<sub>7</sub> is to prevent oscillation. These capacitors need to be small temperature coefficient. These capacitors need also to be arranged near to the terminals of V<sub>CC</sub> and output.

If this arrangement is impossible, the capacitance is recommended to be large.

## 3. Voltage Gain

The closed loop voltage gain G<sub>v</sub> is determined by the ratio of R<sub>1</sub>, R<sub>2</sub> and R<sub>f</sub>.

$$G_v = 20 \log \frac{R_2}{R_1 + R_f} \quad (\text{dB})$$

The recommended voltage gain is more than 40dB.

A voltage gain less than 40dB results in a parastic oscillation.

## 4. Muting Control

Audio muting can be accomplished by connecting PIN ⑥ (ripple filter) to GND as shown in Fig.2.

Amount of muting attenuation is more than 60dB.

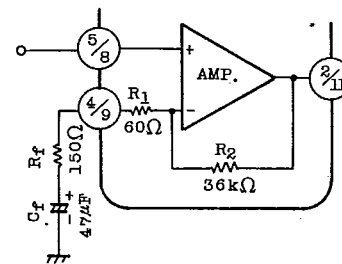

Fig.1

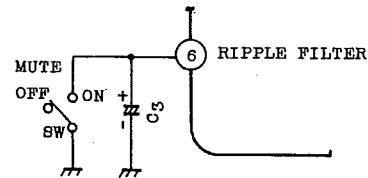

Fig.2

9097247 TOSHIBA, ELECTRONIC

02E 16928 D

**TA7232P**

T-74-05-01

## TYPICAL DC VOLTAGE OF EACH TERMINAL

(V<sub>CC</sub>=9V, T<sub>a</sub>=25°C, DUAL MODE TEST CIRCUIT)

TERMINAL No.	1	2	3	4	5	6	7	8	9	10	11	12
DC Voltage (V)	8.9	4.5	GND	0.55	0.01	5.2	GND	0.01	0.55	8.9	4.5	V <sub>CC</sub>

## EXTERNAL PARTS TABLE AND EXPLANATION (DUAL MODE)

PARTS No.	TYPICAL	PURPOSE	INFLUENCE		NOTE
			SMALLER THAN TYP.	GREATER THAN TYP.	
C1 C2	47μF	Feedback Capacitor	Short Rise Time at V <sub>CC</sub> ON	Long Rise Time at V <sub>CC</sub> ON	
			Low Frequency Roll Off Point : $C_{1,2} = \frac{1}{2\pi f_L \cdot R_{NF}}$		
C3	22μF	Ripple Reducing	Short Rise Time at V <sub>CC</sub> ON	Long Rise Time at V <sub>CC</sub> ON	
C4 C5	100μF	Boot Strap	Low Output Power at Low Frequency	Low POP Noise at V <sub>CC</sub> ON	
C6 C7	0.1μF	Phase Compensation	Unstable for Oscillation at Low Temperature	Stable for Oscillation	Polystyroll Capacitor
C8 C9	1000μF	Coupling Capacitor	Low Frequency Roll Off Point : $C_{8,9} = \frac{1}{2\pi f_L \cdot R_L}$		
C10	1000μF	Ripple Filter	Filter for Hum and Ripple Need the Large Capacitance for AC Supply Small Capacitance is OK for Battery		

AUDIO LINEAR IC

# TA7232P

T-74-05-01

## STANDARD PRINT PATTERN

### UNDER VIEW

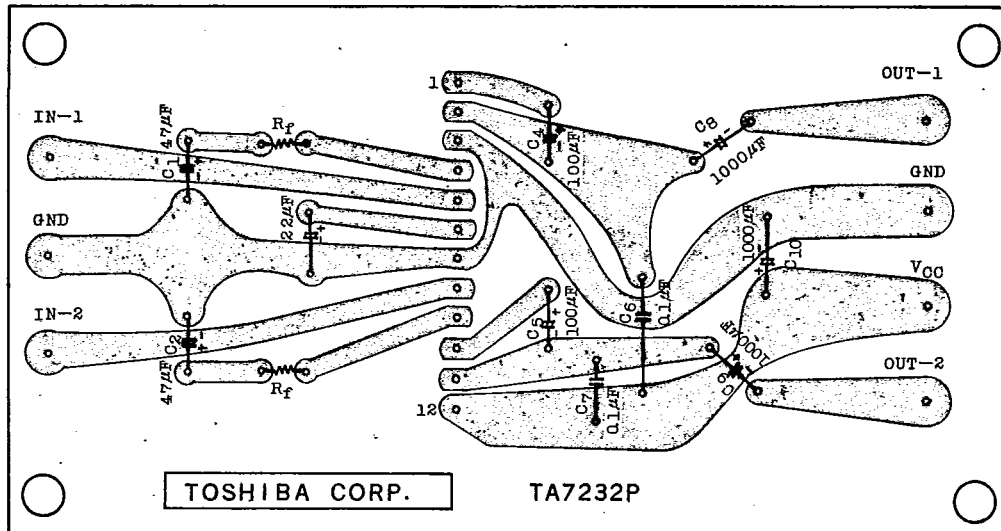

### PARTS DISCIPTION

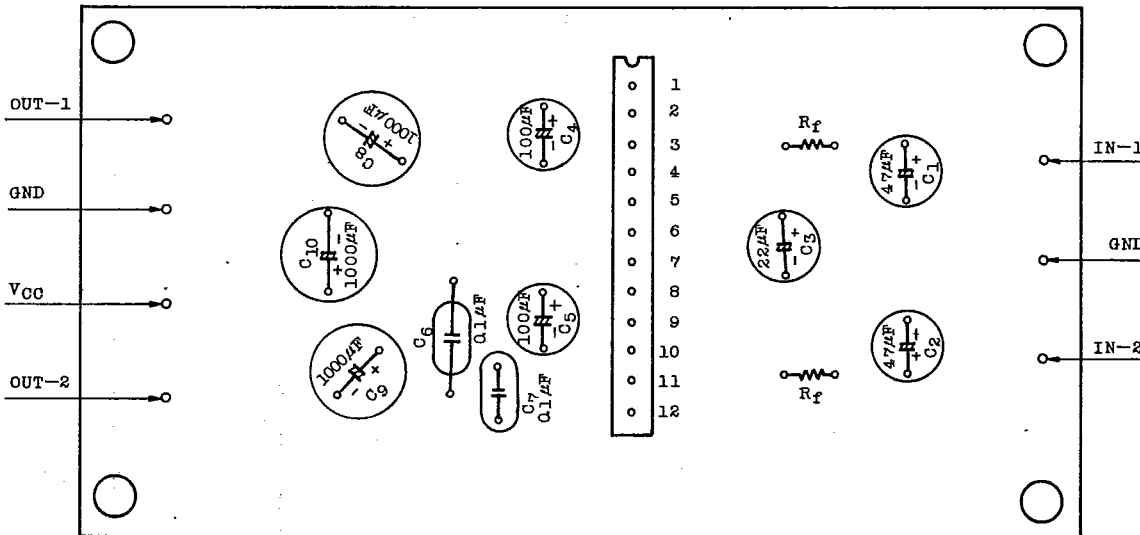

\* C<sub>6</sub>, C<sub>7</sub> are needed to use a polyester film capacitor.

# TA7232P

T-74-05-01

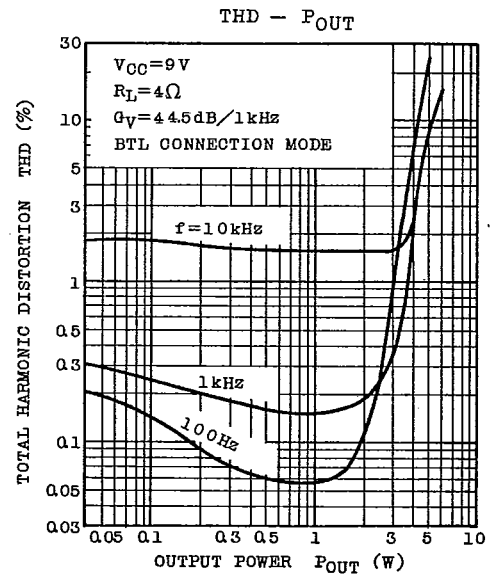
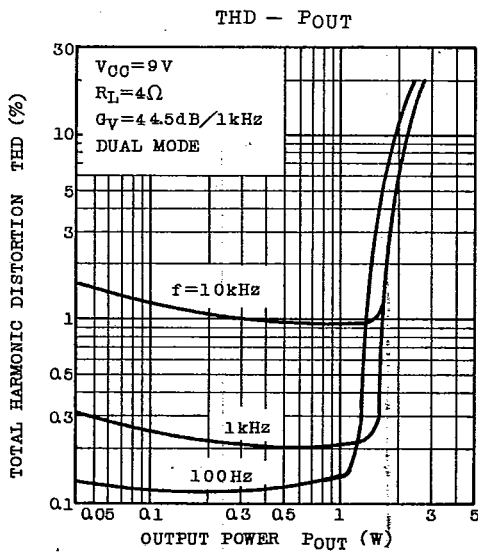
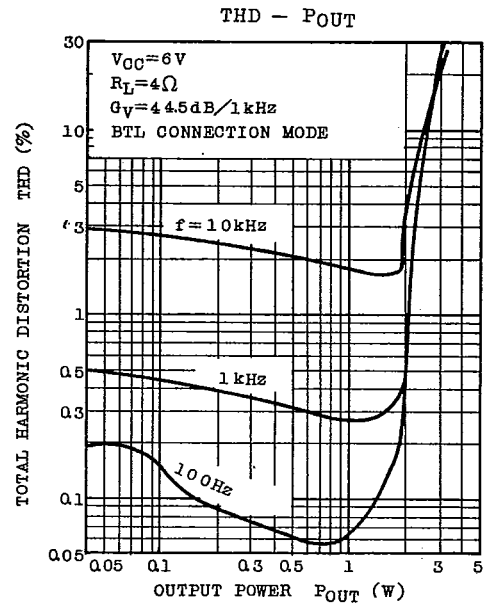
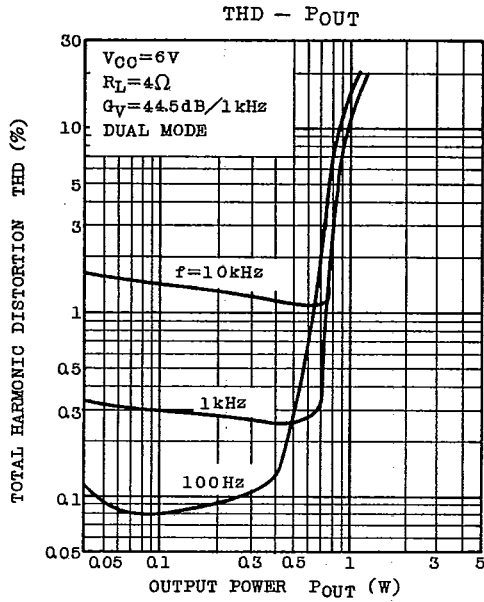

AUDIO LINEAR IC

# TA7232P

T-74-05-01

THD - P<sub>OUT</sub>

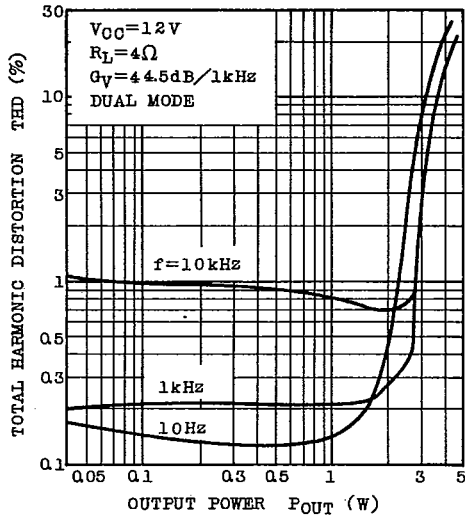

THD - P<sub>OUT</sub>

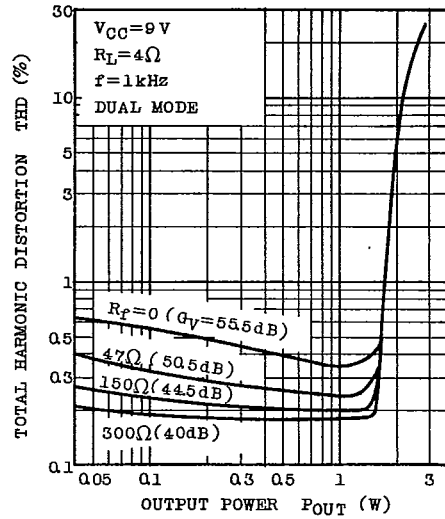

P<sub>OUT</sub> - V<sub>IN</sub>

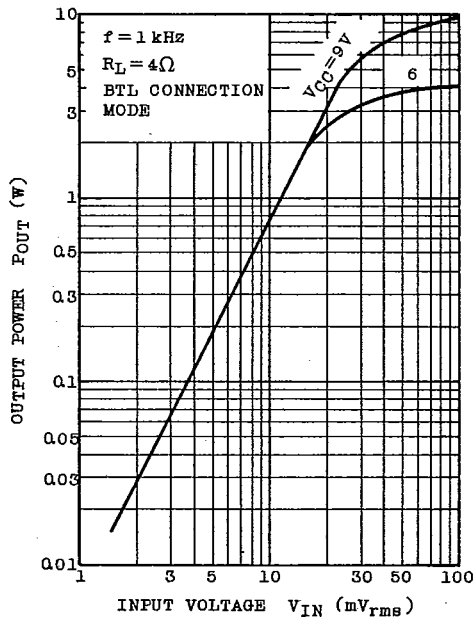

P<sub>OUT</sub> - V<sub>IN</sub>

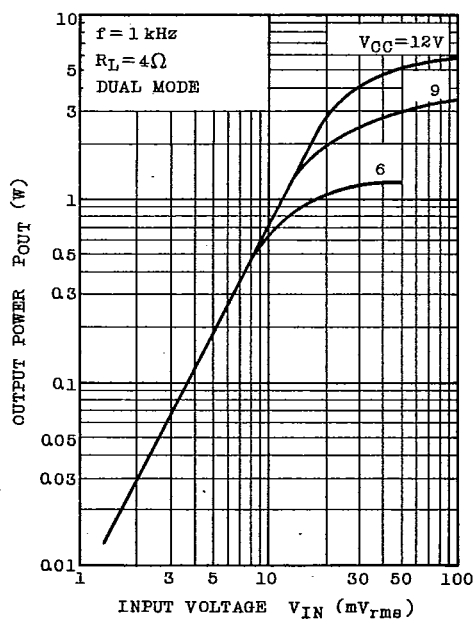



# TA7232P

T-74-05-01

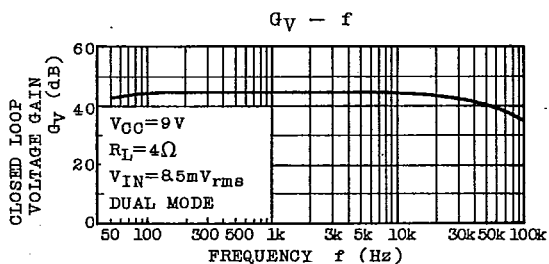
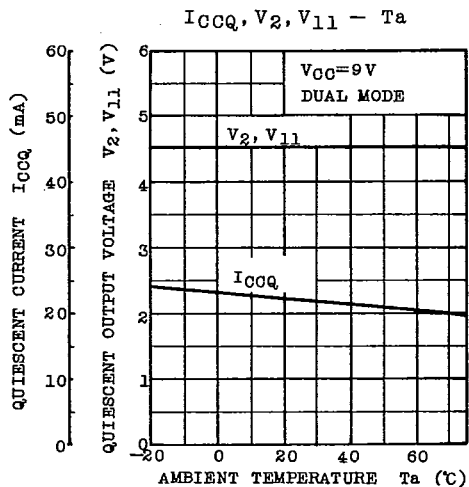
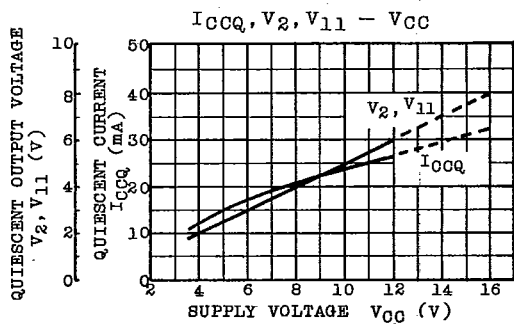
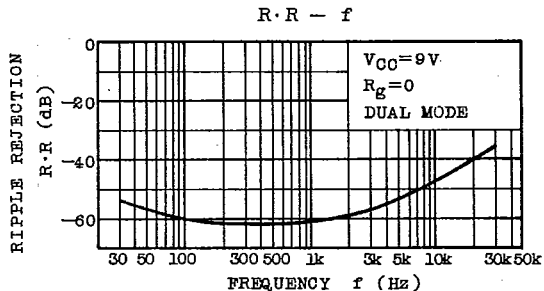
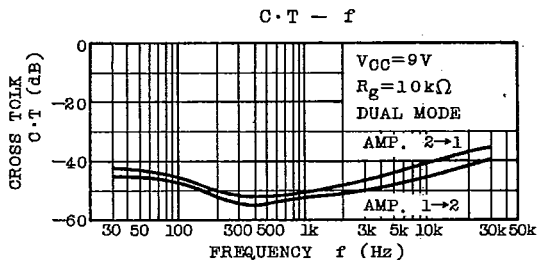
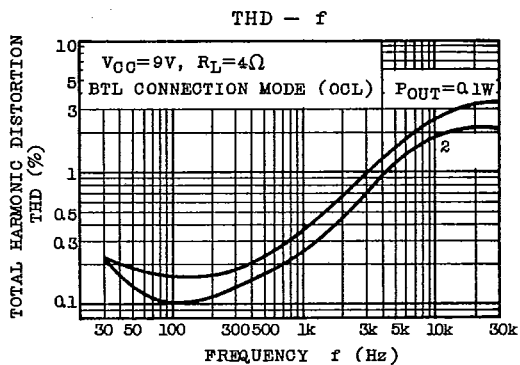
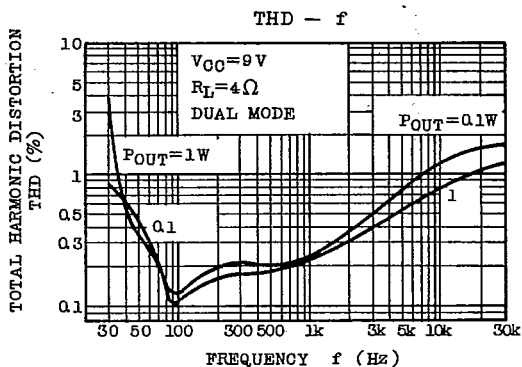

AUDIO LINEAR IC

# TA7232P

T-74-05-01

