



Dual 1 Form A
Solid State Relay

DESCRIPTION

The AD4C211 is a bi-directional, double-pole, single-throw, normally open multipurpose solid-state relay. It is designed to replace electromechanical relays in general purpose switching applications. The relay consists of two integrated circuits, each driving a pair of rugged source-to-source enhancement type DMOS transistors. Each integrated circuit is optically coupled to a light emitting diode. The output MOS transistors are protected with free-wheeling diodes that can handle up to 1.5A of inrush current, making the relay ideal for switching lamps and highly inductive loads.

FEATURES

- High input-to-output isolation
- Low input control power consumption
- 150mA maximum continuous load current
- 20 ohms maximum on-resistance
- Long life/high reliability

APPLICATIONS

- Telecom switching
- Tip/Ring control
- PCMCIA modules
- Multiplexers
- Meter reading systems
- Data acquisition
- Medical equipment
- Battery monitoring
- Home/Safety security systems

OPTIONS/SUFFIXES

- -S Surface Mount Option
- -TR Tape and Reel

SCHEMATIC DIAGRAM

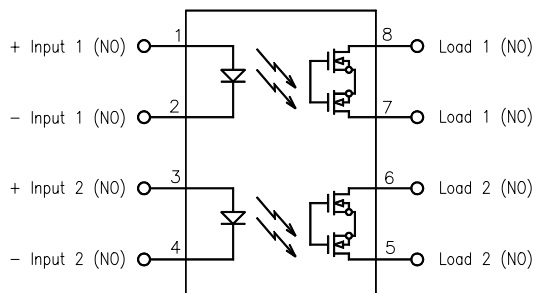

MAXIMUM RATINGS

| PARAMETER | UNIT | MIN | TYP | MAX |
|-------------------------------|------|-----|-----|-----|
| Storage Temperature | °C | -55 | | 125 |
| Operating Temperature | °C | -40 | | 85 |
| Continuous Input Current | mA | | | 40 |
| Transient Input Current | mA | | | 400 |
| Reverse Input Control Voltage | V | 6 | | |
| Output Power Dissipation | mW | | | 500 |

APPROVALS

- BAPT CERTIFICATE #607836:
BS EN 60950, BS EN 41003, BS EN 60065
- CSA CERTIFICATE #LR111581-1
- UL FILE #E90096



Dual 1 Form A
Solid State Relay

ELECTRICAL CHARACTERISTICS - 25°

| PARAMETER | UNIT | MIN | TYP | MAX | TEST CONDITIONS |
|-------------------------------|---------|------|------|-----|----------------------|
| INPUT SPECIFICATIONS | | | | | |
| LED Forward Voltage | V | | 1.2 | 1.5 | If = 10mA |
| LED Reverse Voltage | V | 6 | 12 | | Ir = 10uA |
| Turn-On Current | m A | 5 | 2.5 | | Io = 150mA |
| Turn-Off Current | m A | | 0.5 | | |
| OUTPUT SPECIFICATIONS | | | | | |
| Blocking Voltage | V | 400 | | | Io = 10uA |
| Continuous Load Current | m A | | | 150 | If = 5mA |
| On-Resistance | Ω | | 15 | 20 | Io = 150mA |
| Leakage Current | μ A | | 0.7 | 10 | Vo = 400V |
| Output Capacitance | p F | | 25 | 50 | Vo = 25V, f = 1.0MHz |
| Offset Voltage | m V | | | 0.2 | If = 5mA |
| COUPLED SPECIFICATIONS | | | | | |
| Isolation Voltage | V | 2500 | | | T = 1 minute |
| -H Suffix | V | 3750 | | | T = 1 minute |
| Turn-On Time | m s | | 0.5 | 3 | If = 5mA, Io = 150mA |
| Turn-Off Time | m s | | 0.15 | 1 | If = 5mA, Io = 150mA |
| Isolation Resistance | G Ω | 100 | | | |
| Coupled Capacitance | p F | | 2 | | |
| Contact Transient Ratio | V / μ s | 2000 | 7000 | | dV = 50V |



Dual 1 Form A
Solid State Relay

PERFORMANCE DATA

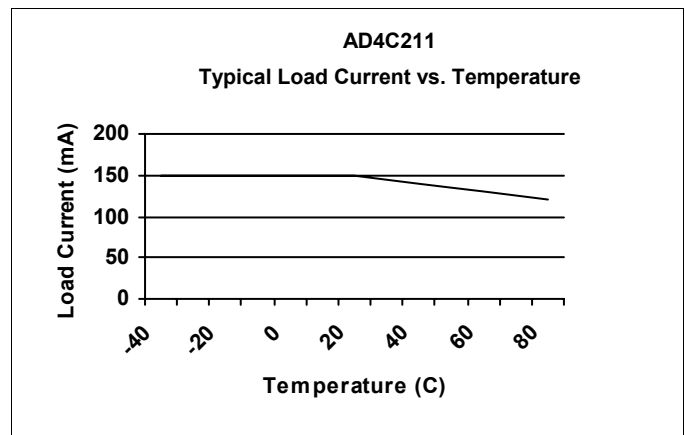
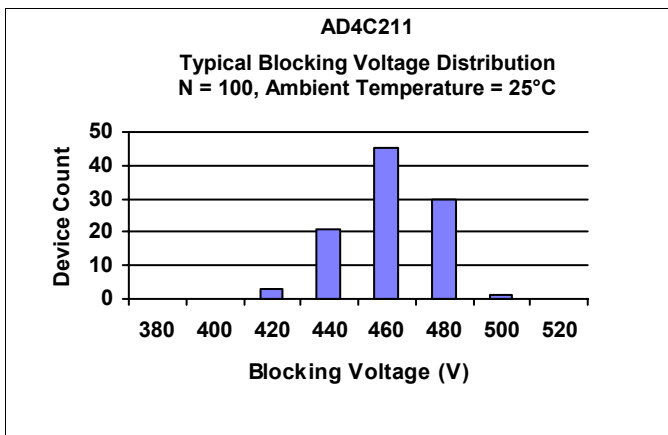
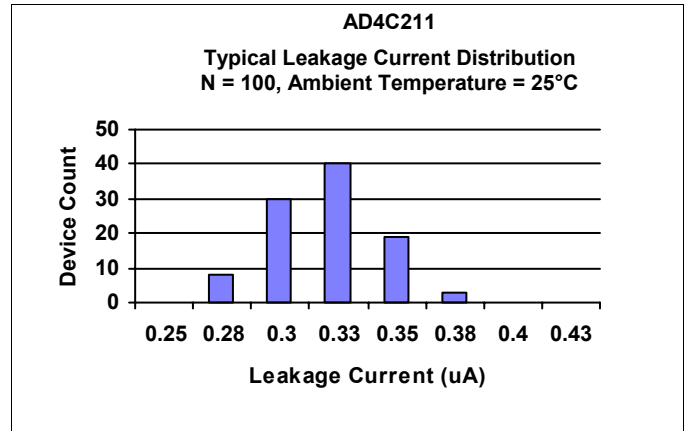
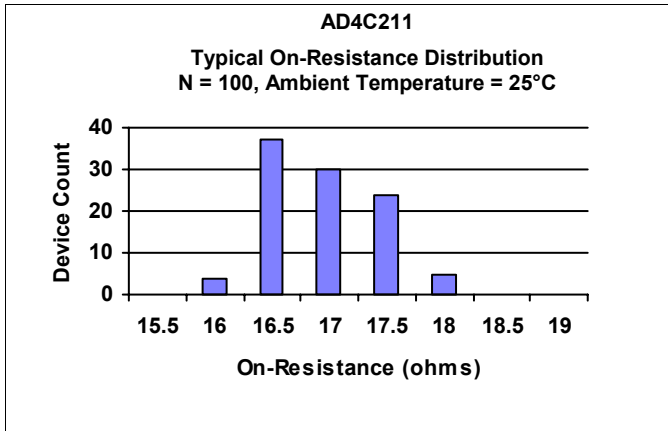
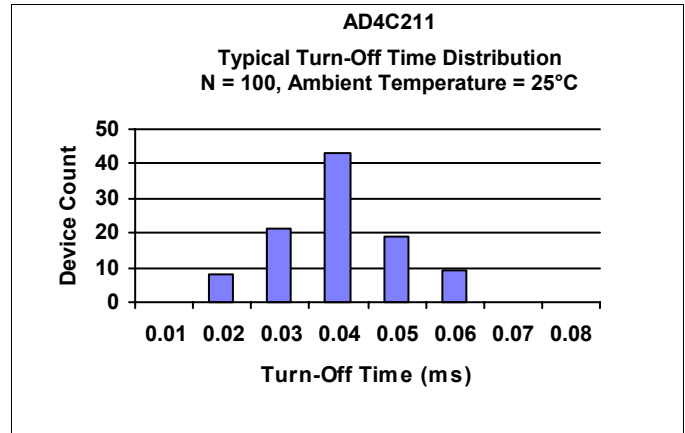
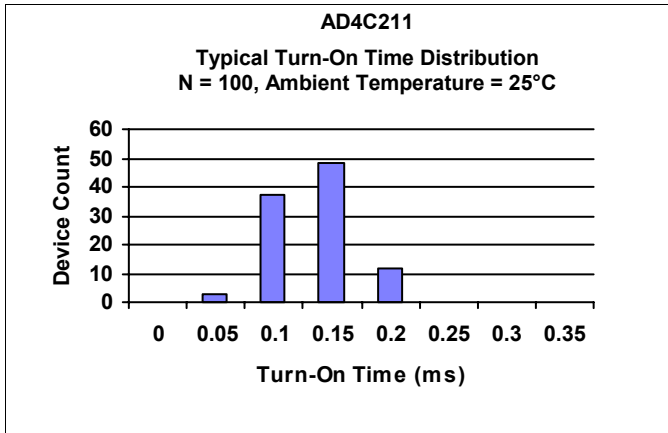



Dual 1 Form A
Solid State Relay

MECHANICAL DIMENSIONS

8 PIN DUAL IN-LINE PACKAGE

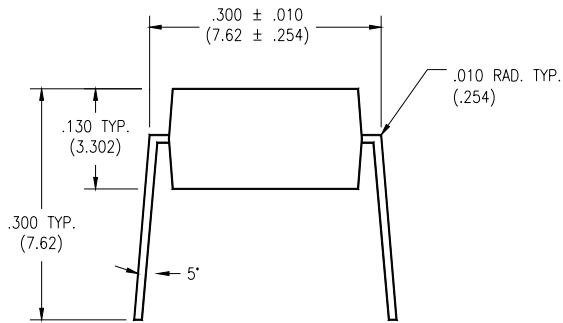

END VIEW

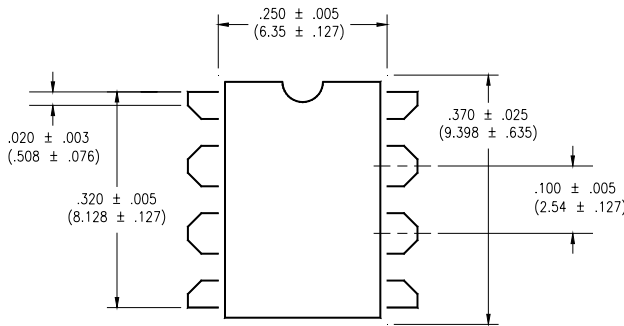

TOP VIEW

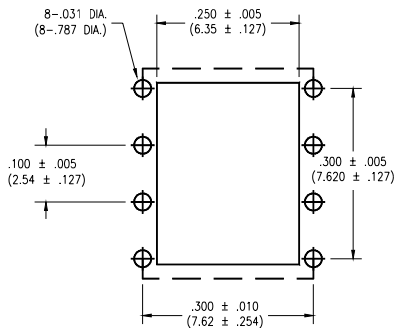

**BOTTOM VIEW/
BOARD PATTERN**

8 PIN SURFACE MOUNT DEVICE

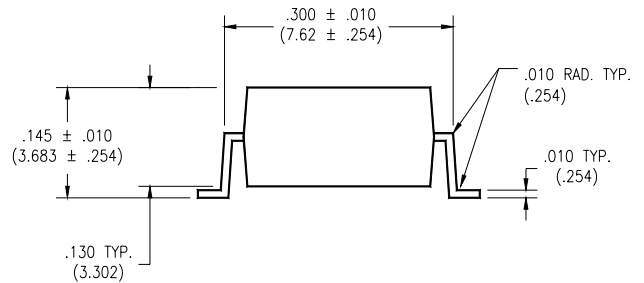

END VIEW

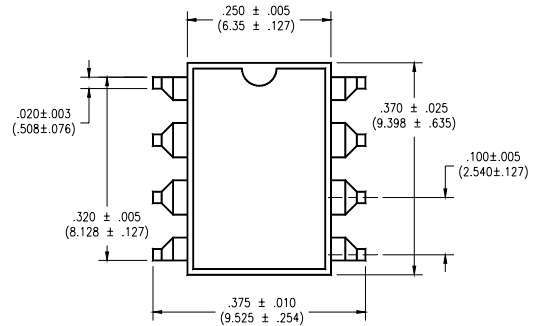

TOP VIEW

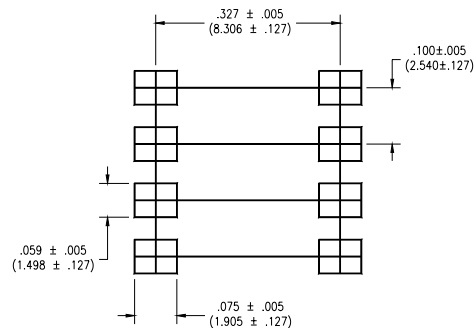

**BOTTOM VIEW/
BOARD PATTERN**

Pour plus d'information, merci de contacter le distributeur en
France :

ISC-DISTREL

1 Avenue du Président Pompidou

BP 50801

92508 Rueil Malmaison Cedex

Tel : 01.41.39.25.00

Fax : 01.47.32.99.25

www.isc-distrel.com

contact@isc-distrel.com